

# Surface Mount Zener Diode

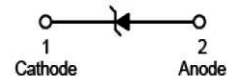

## Features:

- Planar Die Construction
- 500mW Power Dissipation On Ceramic PCB
- General Purpose, Medium Current
- Ideally Suited For Automated Assembly Processes



**SOD-123**

## Applications:

Zener diode  
Ultra-small surface mount package

## Max. Rating @ T<sub>A</sub> = 25°C unless otherwise specified

Parameter	Symbol	Limits	Unit
Forward voltage @ I <sub>F</sub> = 10mA	V <sub>F</sub>	0.9	V
Power dissipation	P <sub>D</sub>	500	mW
Thermal resistance junction to ambient air	R <sub>θJA</sub>	305	°C/W
Operating junction temperature range	T <sub>j</sub>	150	°C
Storage temperature range	T <sub>STG</sub>	-65 to +150	°C

**Note** : Device mounted on ceramic PCB; 7.6mm × 9.4mm × 0.87mm with pad areas 25mm<sup>2</sup>

Short duration test pulse used to minimize self-heating effect.

When provided, otherwise, parts are provided with date code only, and type number identifications appears on reel only.  
f = 1kHz

## Electrical Characteristics @ T<sub>A</sub> = 25°C unless otherwise specified

Marking Code	Zener Voltage Range				Max. Zener Impedance			Max. Reverse Current		Typical Temperature Coefficient@ I <sub>ZTC</sub> mV/°C		Test Current I <sub>ZTC</sub> mA
	V <sub>Z</sub> @ I <sub>ZT</sub>			I <sub>ZT</sub>	Z <sub>ZT</sub> @I <sub>ZT</sub>	Z <sub>ZK</sub> @I <sub>ZK</sub>	I <sub>ZK</sub>	I <sub>R</sub>	V <sub>R</sub>	Min.	Max.	
	Nom(V)	Min(V)	Max(V)	mA	Ω	mA	μA	V				
WI	13	12.4	14.1	5	30	170	1	0.1	8	7	11	5

# Surface Mount Zener Diode



Typical Characteristics @  $T_A = 25^\circ\text{C}$  unless otherwise specified

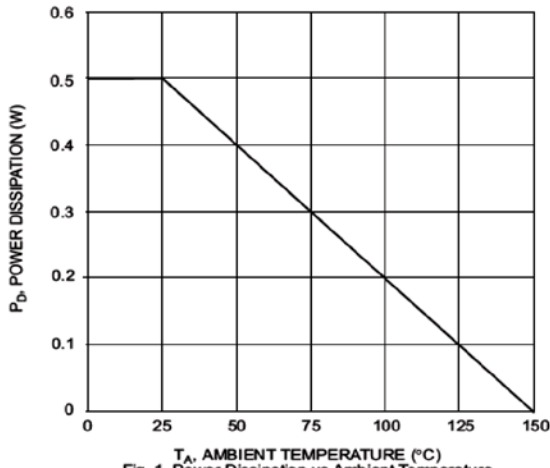

Fig. 1 Power Dissipation vs Ambient Temperature

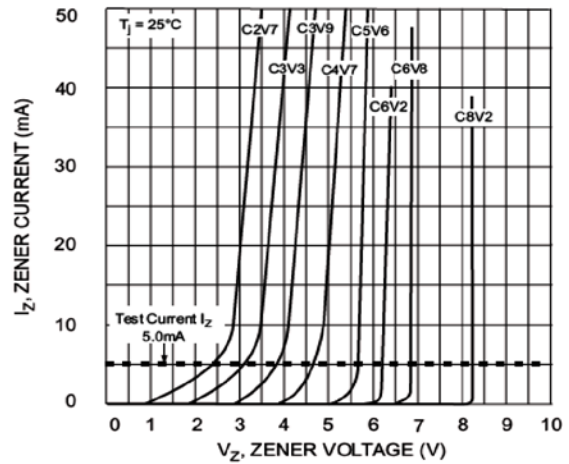

Fig. 2 Zener Breakdown Characteristics

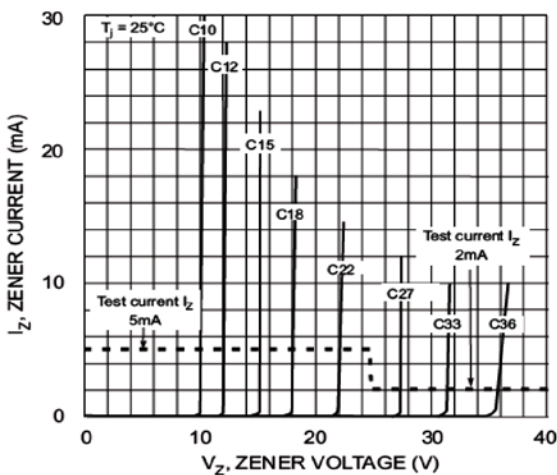

Fig. 3 Zener Breakdown Characteristics

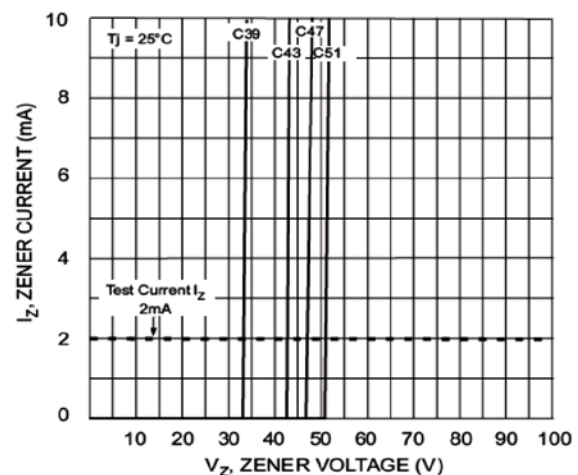

Fig. 4 Zener Breakdown Characteristics

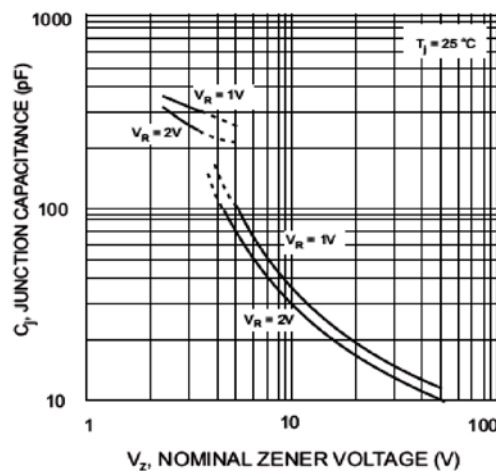

Fig. 5 Junction Capacitance vs Nominal Zener Voltage



# Surface Mount Zener Diode



## Plastic surface mounted package

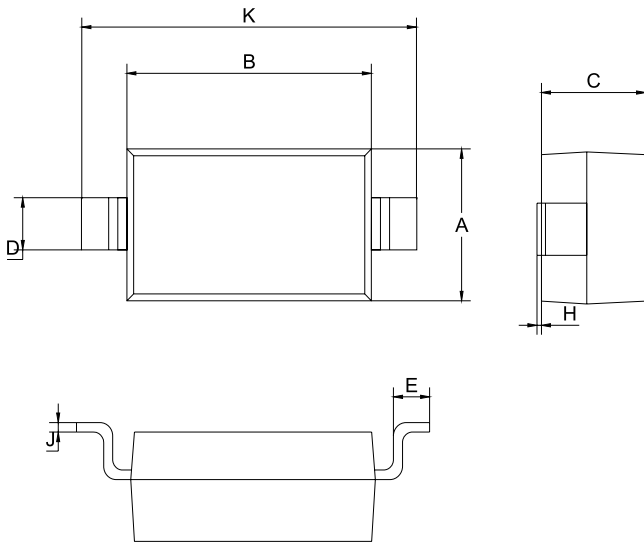

SOD-123		
Dim	Min	Max
A	1.4	1.8
B	2.55	2.85
C	1.15 Typical	
D	0.5	0.6
E	0.3	0.4
H	0.02	0.10
J	0.1 Typical	
K	3.55	3.85
All Dimensions in mm		

## Soldering Footprint

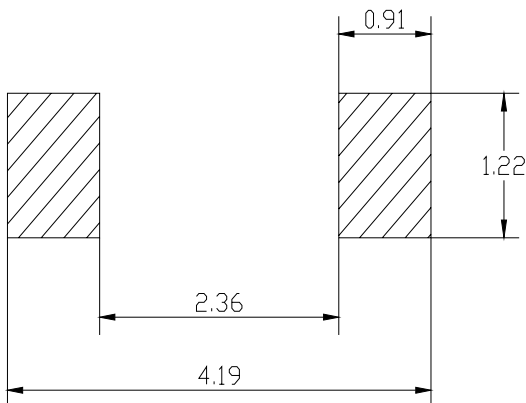

Unit : mm

## Package Information

Device	Package	Shipping
BZT52C13-7-F	SOD-123	3,000 / Tape & Reel

## Part Number Table

Description	Part Number
Surface mount zener diode	BZT52C13-7-F

**Important Notice :** This data sheet and its contents (the "Information") belong to the members of the Premier Farnell group of companies (the "Group") or are licensed to it. No licence is granted for the use of it other than for information purposes in connection with the products to which it relates. No licence of any intellectual property rights is granted. The Information is subject to change without notice and replaces all data sheets previously supplied. The Information supplied is believed to be accurate but the Group assumes no responsibility for its accuracy or completeness, any error in or omission from it or for any use made of it. Users of this data sheet should check for themselves the Information and the suitability of the products for their purpose and not make any assumptions based on information included or omitted. Liability for loss or damage resulting from any reliance on the Information or use of it (including liability resulting from negligence or where the Group was aware of the possibility of such loss or damage arising) is excluded. This will not operate to limit or restrict the Group's liability for death or personal injury resulting from its negligence. Multicomp is the registered trademark of the Group. © Premier Farnell plc 2012.

