

High voltage, high current Darlington transistor array

BA12001B / BA12003B / BA12003BF / BA12004B

The BA12001B, BA12003B, BA12003BF, and BA12004B are high voltage, high current, high sustain voltage transistor arrays consisting of seven circuits of Darlington transistors.

Because it incorporates built-in surge-absorbing diodes and base current-control resistors needed when using inductive loads such as relay coils, attachments can be kept to a minimum.

With an output sustain voltage as high as 60V and an output current (sink current) of 500mA, this product is ideal for use with various drivers and as an interface with other elements.

●Applications

Drivers for LEDs, lamps, relays and solenoids

Interface with other elements

●Features

- 1) High output current. ($I_{OUT}=500\text{mA Max.}$)
- 2) High output sustain voltage. ($V_{OUT}=50\text{V Max.}$)
- 3) Seven Darlington transistors built in.
- 4) Built-in surge-absorbing clamp diode.

(Note : Refer to the "Reference items when using in application.")

●Block diagram

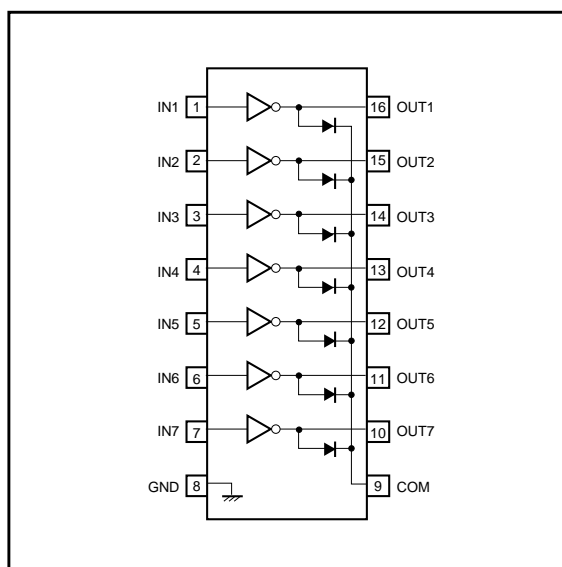

BA12001B / BA12003B / BA12003BF / BA12004B

Standard ICs

●Internal circuit configuration

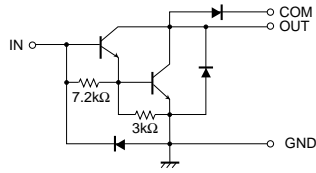

Fig.1 BA12001B

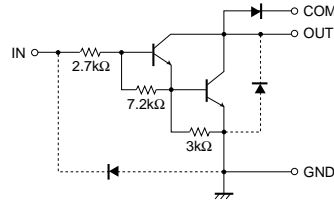

Fig.2 BA12003B / BF

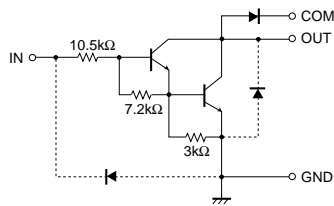

Fig.3 BA12004B

●Absolute maximum ratings (Ta=25°C)

Parameter		Symbol	Limits	Unit
Power supply voltage		V _{CE}	60	V
Input voltage	other than BA12001B	V _{IN}	-0.5~+30	V
Input current	BA12001B	I _{IN}	25	mA / unit
Output current		I _{OUT}	500	mA / unit
Ground pin current		I _{GND}	2.3*1	A
Power dissipation	DIP package	P _d	1250*2	mW
	SOP package		625*3	
Diode reverse voltage		V _R	60	V
Diode forward current		I _F	500	mA
Operating temperature		T _{opr}	-25~+75	°C
Storage temperature		T _{stg}	-55~+150	°C

*1 Pulse width ≤ 20ms, duty cycle ≤ 10%, same current for all 7 circuits

*2 Reduced by 10mW for each increase in Ta of 1°C over 25°C .

*3 Reduced by 50mW for each increase in Ta of 1°C over 25°C .

●Recommended operating conditions (Ta=25°C)

Parameter	Symbol	Min.	Typ.	Max.	Unit	Conditions
Output current	I _{OUT}	-	-	350	mA	Fig.9, 10
Power supply voltage	V _{CE}	-	-	55	V	-
Input voltage (excluding BA12001B)	V _{IN}	-	-	30	V	-
Input current (BA12001B only)	I _{IN}	-	-	25	mA / unit	-

BA12001B / BA12003B / BA12003BF / BA12004B

Standard ICs

●Electrical characteristics (Ta=25°C)

Parameter		Symbol	Min.	Typ.	Max.	Unit	Conditions
Output leakage current		I_L	–	0	10	μA	$V_{CE} = 60\text{V}$
DC current transfer ratio		h_{FE}	1000	2400	–	V	$V_{CE} = 2\text{V}, I_{OUT} = 350\text{mA}$
Output saturation voltage		$V_{CE(sat)}$	–	0.94	1.1	V	$I_{OUT} = 100\text{mA}, I_{IN} = 250\mu\text{A}$
				1.14	1.3		$I_{OUT} = 200\text{mA}, I_{IN} = 350\mu\text{A}$
				1.46	1.6		$I_{OUT} = 350\text{mA}, I_{IN} = 500\mu\text{A}$
Input voltage	BA12003B / BF	V_{IN}	–	1.75	2	V	$V_{CE} = 2\text{V}, I_{OUT} = 100\text{mA}$
	BA12004B			2.53	5		
	BA12003B / BF	V_{IN}	–	1.91	2.4	V	$V_{CE} = 2\text{V}, I_{OUT} = 200\text{mA}$
	BA12004B			2.75	6		
	BA12003B / BF	V_{IN}	–	2.17	3.4	V	$V_{CE} = 2\text{V}, I_{OUT} = 350\text{mA}$
	BA12004B			3.27	8		
Input current	BA12003B / BF	I_{IN}	–	0.90	1.35	mA	$V_{IN} = 3.85\text{V}$
	BA12004B			0.39	0.5		$V_{IN} = 5\text{V}$
Diode reverse current		I_R	–	0	50	μA	$V_R = 60\text{V}$
Diode forward voltage		V_F	–	1.73	2	V	$I_F = 350\text{mA}$
Input capacitance		C_{IN}	–	30	–	pF	$V_{IN} = 0\text{V}, f = 1\text{MHz}$

Note: Input voltage and input current for BA12001 vary based on external resistor.

●Measurement circuits

(1) Output leakage current I_L

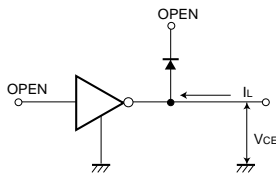

(2) DC current transfer ratio $h_{FE} = \frac{I_o}{I_i}$
Output saturation voltage $V_{CE(sat)}$

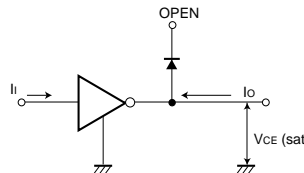

(3) Input voltage V_{IN}

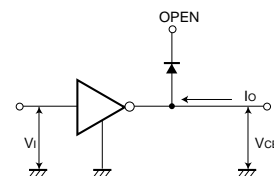

(4) Input current I_{IN}

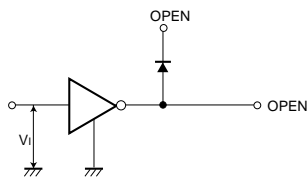

(5) Diode reverse current I_R

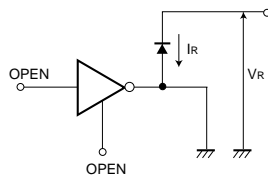

(6) Diode forward voltage V_F

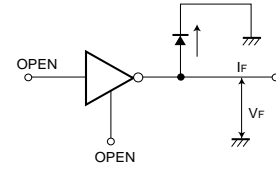

(7) Input capacitance C_{IN}

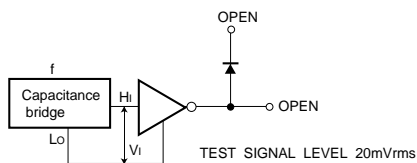

Fig.4

Standard ICs

●Application example

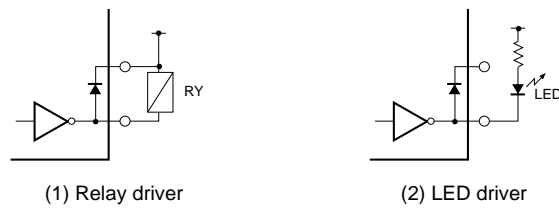

Fig.5

●Application notes

The BA12001B is a transistor array which can be directly coupled to a general logic circuit such as PMOS, CMOS, or TTL.

A current limiting resistor needs to be connected in series with the input.

The BA12003B / BF can be coupled directly to TTL or CMOS output (when operating at 5V). In order to limit the input current to a stable value, resistors are connected in series to each of the inputs.

The BA12004B is designed for direct coupling to CMOS or PMOS output using a 6 to 15V power supply voltage. In order to limit the input current to a stable value, resistors are connected in series to each of the inputs.

The load for each of these products should be connected between the driver output and the power supply. To protect the IC from excessive swing voltage, the COM pin (Pin 9) should be connected to the power supply.

Fig.6 shows the configuration of the on-chip diode for surge absorption.

In the construction of the surge-absorbing diode, there is an N-P junction between the N-layer (N-well + BL) and the substrate (P-sub) so that when the diode is on, current flows from the output pin to the substrate. In terms of the vertical construction, this diode is configured similar to a PNP transistor. When using the surge-absorbing diode, take appropriate measures regarding the thermal characteristics of the design considering the current that will be handled.

Also, if motor back-rush current or other conditions that will result continued surge current to flow to the surge-absorbing diode can be foreseen, we strongly recommend connecting a Schottky barrier diode (or other type of diode with a low forward voltage) in parallel with the surge-absorbing diode to construct a bypass route for the surge current.

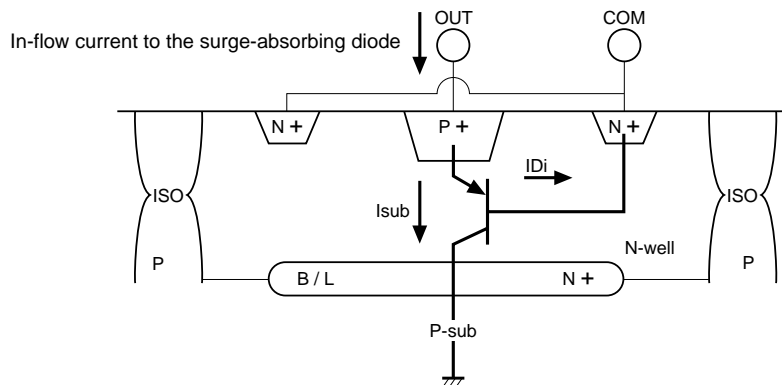

Fig.6 Vertical construction of the surge-absorbing diode

BA12001B / BA12003B / BA12003BF / BA12004B

Standard ICs

●Electrical characteristic curves

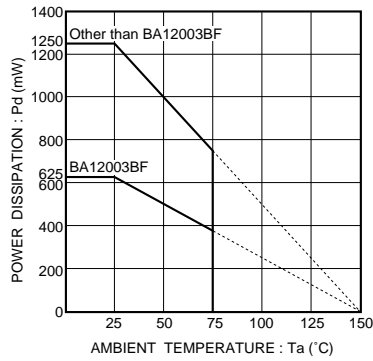

Fig.7 Power dissipation vs. ambient temperature



Fig.8 Output conditions (I)

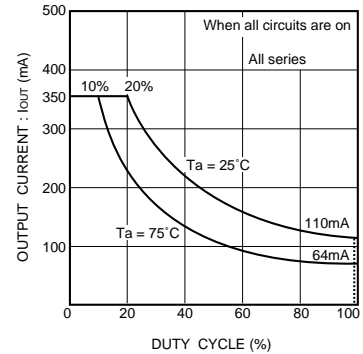

Fig.9 Output conditions (II)

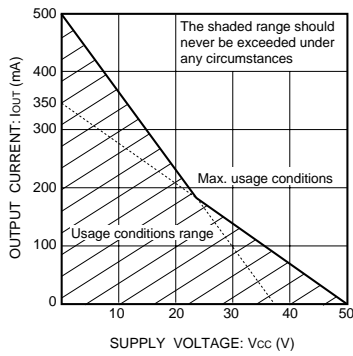

Fig.10 Usage conditions range per circuit

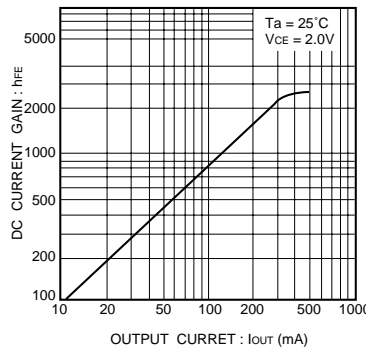

Fig.11 DC current transfer ratio vs. output current

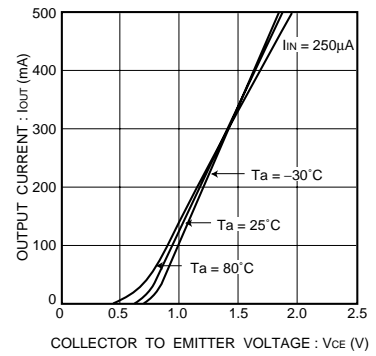

Fig.12 Output current vs. voltage between collector and emitter

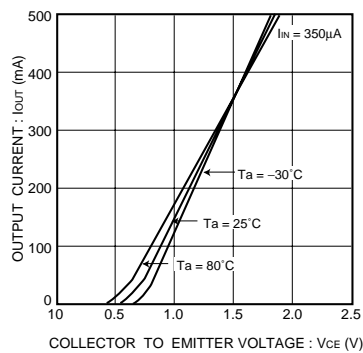

Fig.13 Output current vs. voltage between collector and emitter

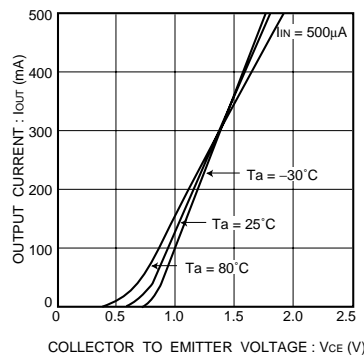

Fig.14 Output current vs. voltage between collector and emitter

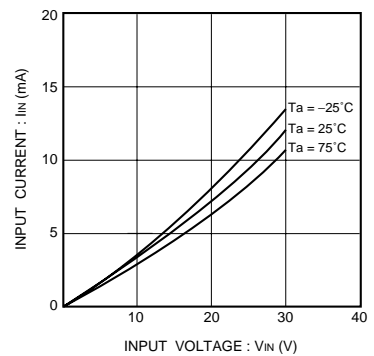

Fig.15 Input current vs. input voltage (BA12003B / BF)

BA12001B / BA12003B / BA12003BF / BA12004B

Standard ICs

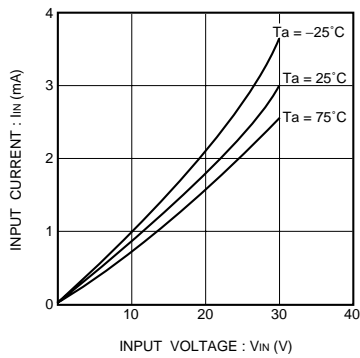

Fig.16 Input current vs. input voltage (BA12004B)

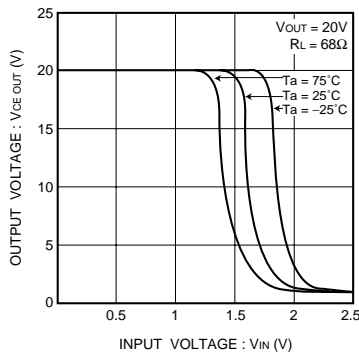

Fig.17 Output voltage vs. input voltage (BA12003B / BF)

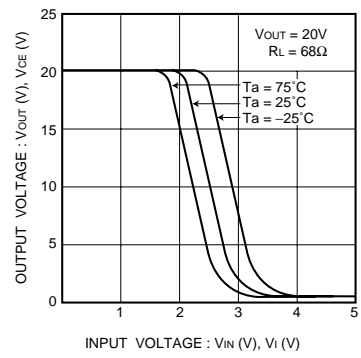
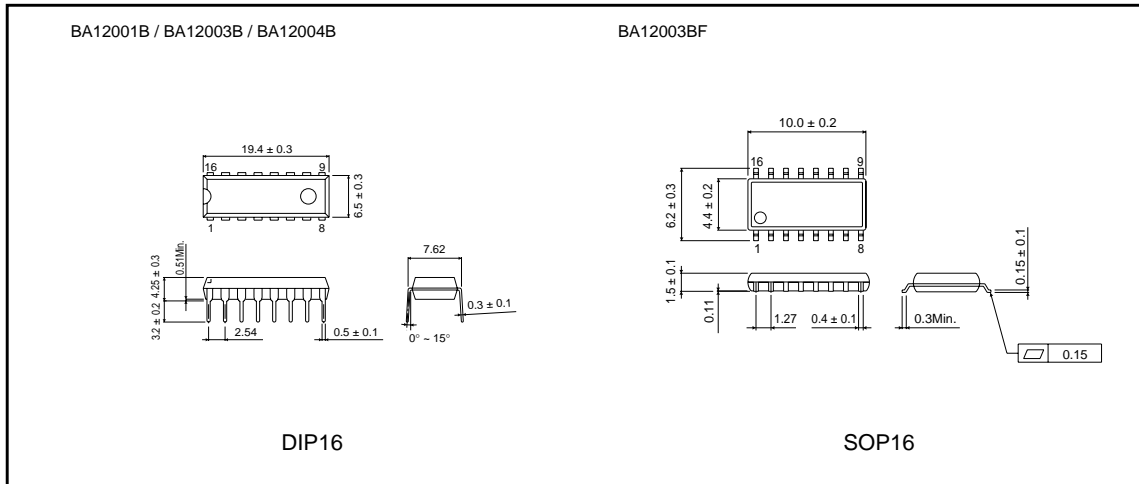

Fig.18 Output voltage vs. input voltage (BA12004B)

External dimensions (Units : mm)



Notes

- No technical content pages of this document may be reproduced in any form or transmitted by any means without prior permission of ROHM CO.,LTD.
- The contents described herein are subject to change without notice. The specifications for the product described in this document are for reference only. Upon actual use, therefore, please request that specifications to be separately delivered.
- Application circuit diagrams and circuit constants contained herein are shown as examples of standard use and operation. Please pay careful attention to the peripheral conditions when designing circuits and deciding upon circuit constants in the set.
- Any data, including, but not limited to application circuit diagrams information, described herein are intended only as illustrations of such devices and not as the specifications for such devices. ROHM CO.,LTD. disclaims any warranty that any use of such devices shall be free from infringement of any third party's intellectual property rights or other proprietary rights, and further, assumes no liability of whatsoever nature in the event of any such infringement, or arising from or connected with or related to the use of such devices.
- Upon the sale of any such devices, other than for buyer's right to use such devices itself, resell or otherwise dispose of the same, no express or implied right or license to practice or commercially exploit any intellectual property rights or other proprietary rights owned or controlled by
- ROHM CO., LTD. is granted to any such buyer.
- Products listed in this document use silicon as a basic material.
Products listed in this document are no antiradiation design.

The products listed in this document are designed to be used with ordinary electronic equipment or devices (such as audio visual equipment, office-automation equipment, communications devices, electrical appliances and electronic toys).

Should you intend to use these products with equipment or devices which require an extremely high level of reliability and the malfunction of which would directly endanger human life (such as medical instruments, transportation equipment, aerospace machinery, nuclear-reactor controllers, fuel controllers and other safety devices), please be sure to consult with our sales representative in advance.

About Export Control Order in Japan

Products described herein are the objects of controlled goods in Annex 1 (Item 16) of Export Trade Control Order in Japan.

In case of export from Japan, please confirm if it applies to "objective" criteria or an "informed" (by MITI clause) on the basis of "catch all controls for Non-Proliferation of Weapons of Mass Destruction.