

SBD Type : ECL06B03

OUTLINE DRAWING

FEATURES

- * TO-251AA Case
- * Dual Diodes Cathode Common
- * Extremely Low Forward Voltage drop
- * Low Power Loss,High Efficiency
- * High Surge Capability

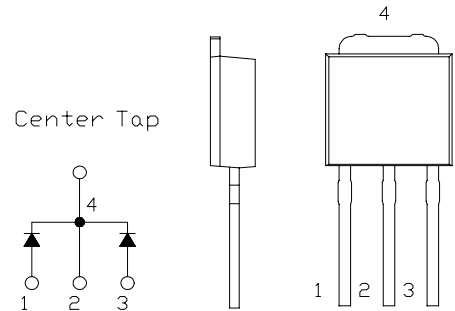

Maximum Ratings

Approx Net Weight:0.35g

Rating	Symbol	ECL06B03		Unit
Repetitive Peak Reverse Voltage	V_{RRM}	30		V
Average Rectified Output Current	I_O	6.0	$T_c=70^\circ\text{C}$ 50Hz Full Sine Wave Resistive Load	A
RMS Forward Current	$I_{F(RMS)}$	6.66		A
Surge Forward Current	I_{FSM}	45	50Hz Full Sine Wave, 1cycle, Non-repetitive	A
Operating Junction Temperature Range	T_{jw}	- 40 to + 100		$^\circ\text{C}$
Storage Temperature Range	T_{stg}	- 40 to + 125		$^\circ\text{C}$

Electrical • Thermal Characteristics

Characteristics	Symbol	Conditions	Min	Typ	Max	Unit
Peak Reverse Current	I_{RM}	$T_j=25^\circ\text{C}, V_{RM}=V_{RRM}$ per Arm	-	-	3.0	mA
Peak Forward Voltage	V_{FM}	$T_j=25^\circ\text{C}, I_{FM}= 3 \text{ A}$ per Arm	-	-	0.47	V
Thermal Resistance	Junction to Case	$R_{th(j-c)}$	-	-	5	$^\circ\text{C/W}$

ECL06B03 OUTLINE DRAWING (Dimensions in mm)

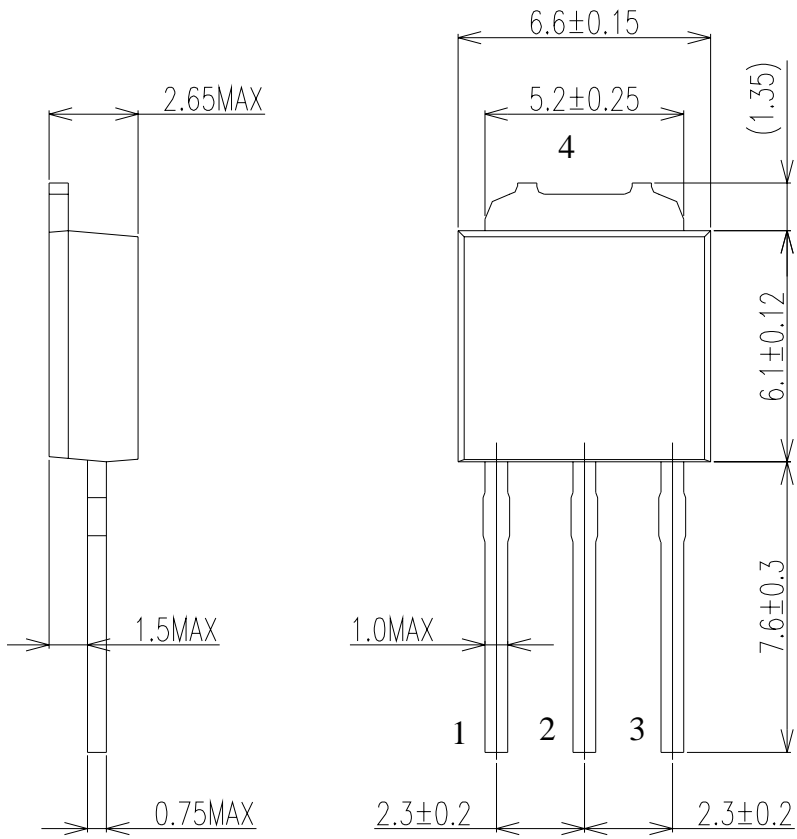

Center Tap

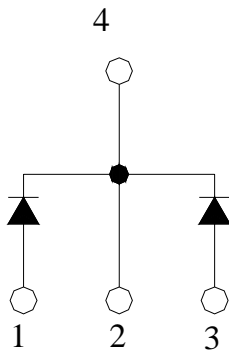

FORWARD CURRENT VS. VOLTAGE

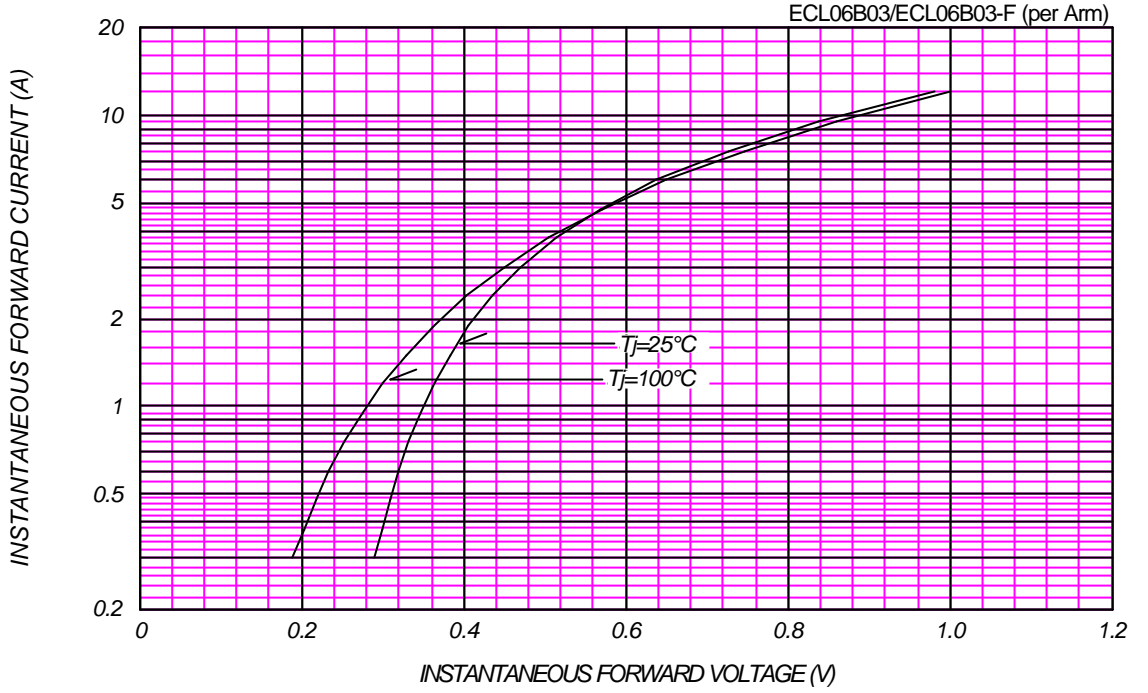

AVERAGE FORWARD POWER DISSIPATION

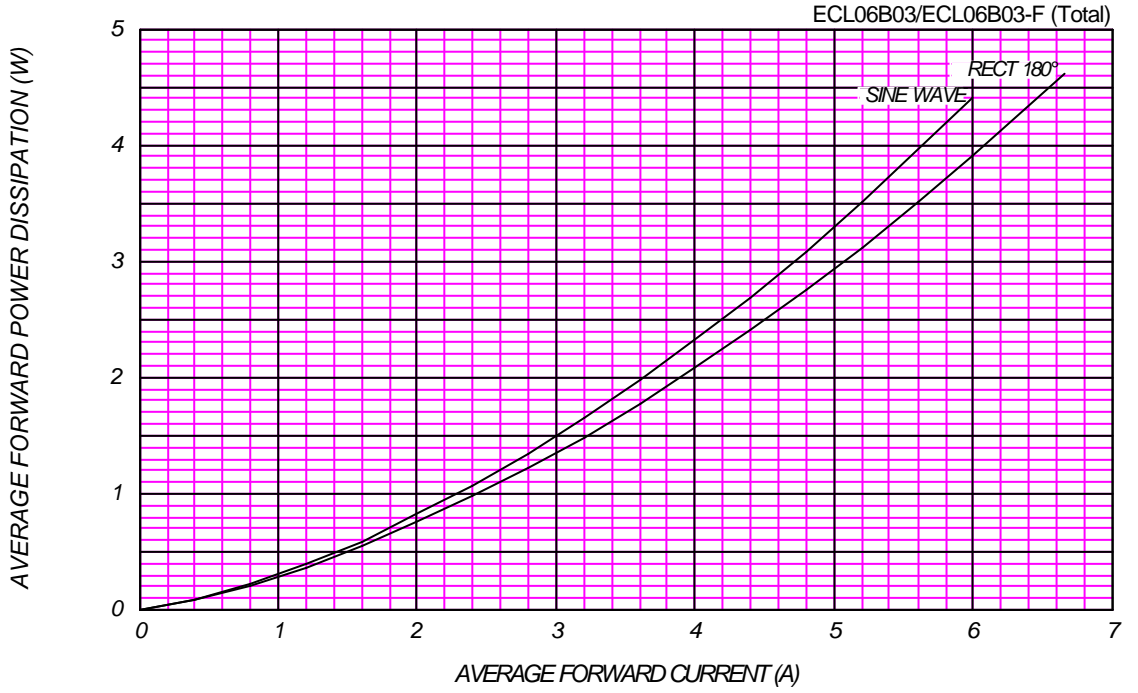

PEAK REVERSE CURRENT VS. PEAK REVERSE VOLTAGE

$T_j = 100\text{ }^\circ\text{C}$

ECL06B03/ECL06B03-F (per Arm)

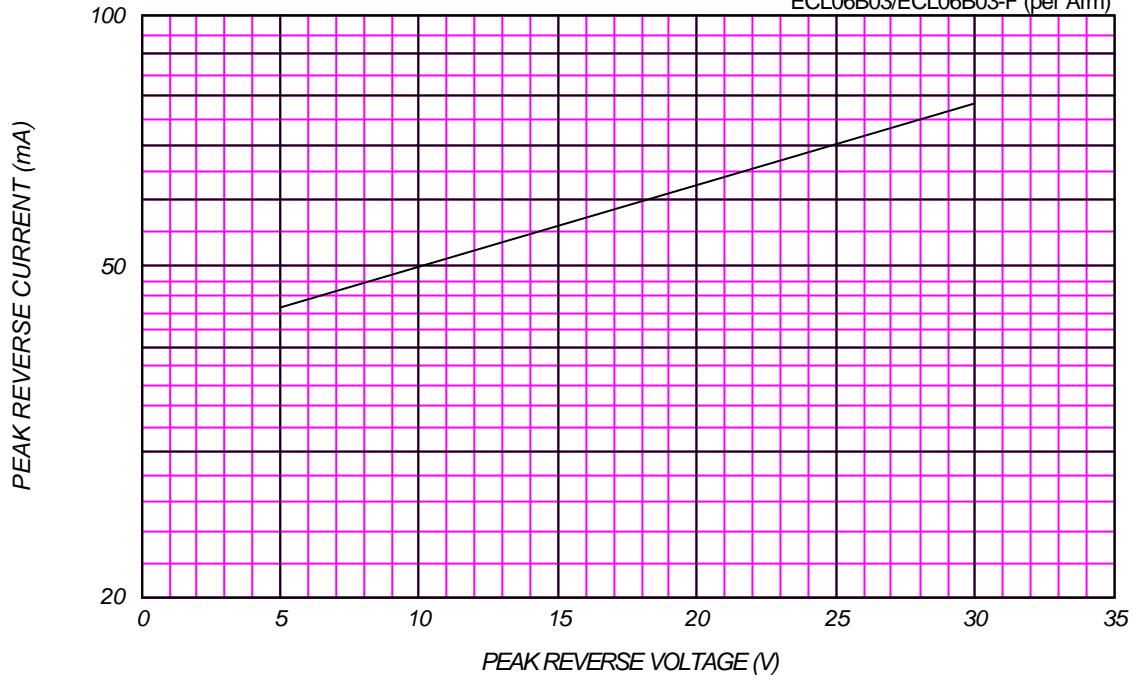

AVERAGE REVERSE POWER DISSIPATION

ECL06B03/ECL06B03-F (Total)

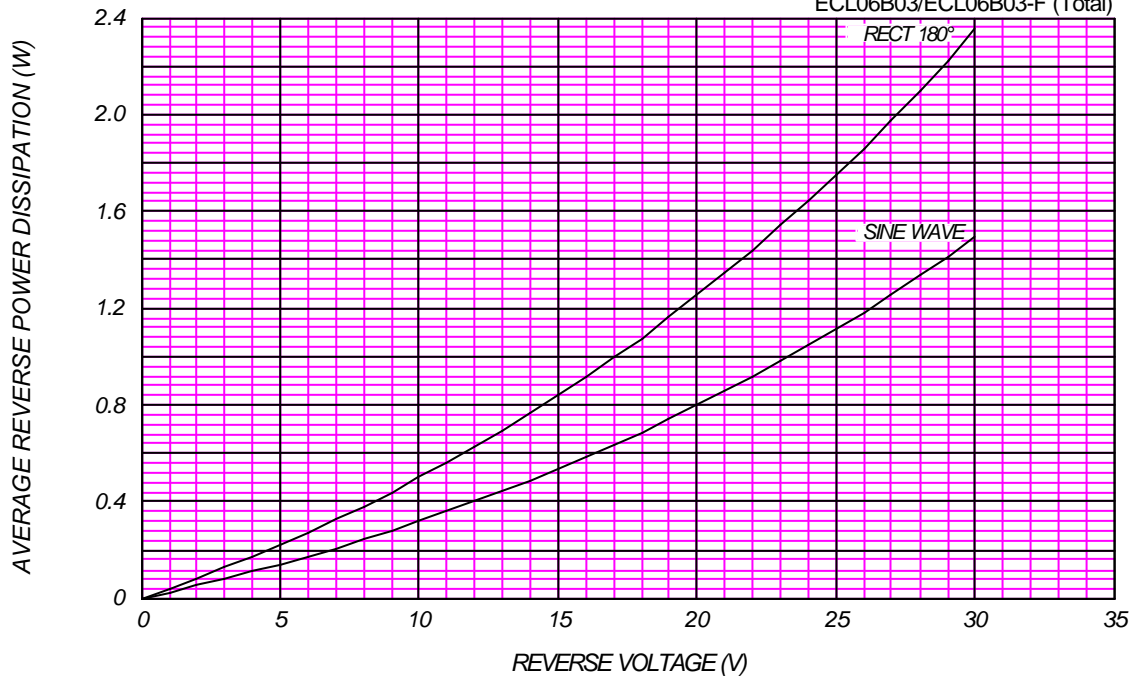



AVERAGE FORWARD CURRENT VS. CASE TEMPERATURE

$V_{RM}=30$

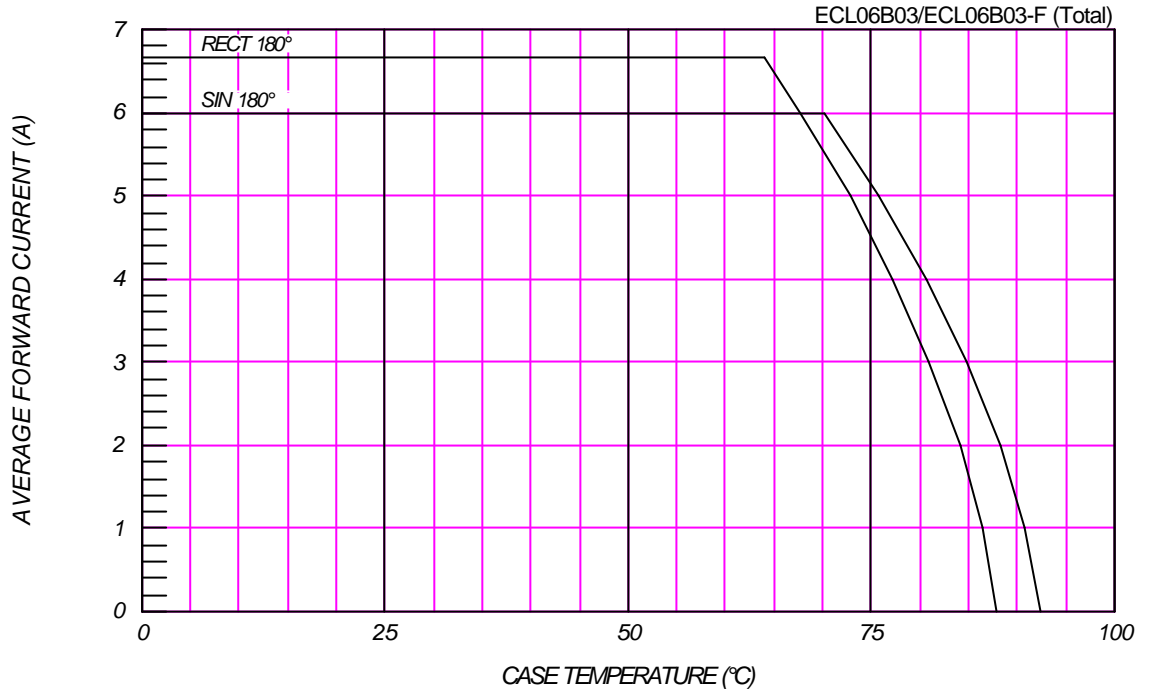

SURGE CURRENT RATINGS

f=50Hz, Sine Wave, Non-Repetitive, No Load

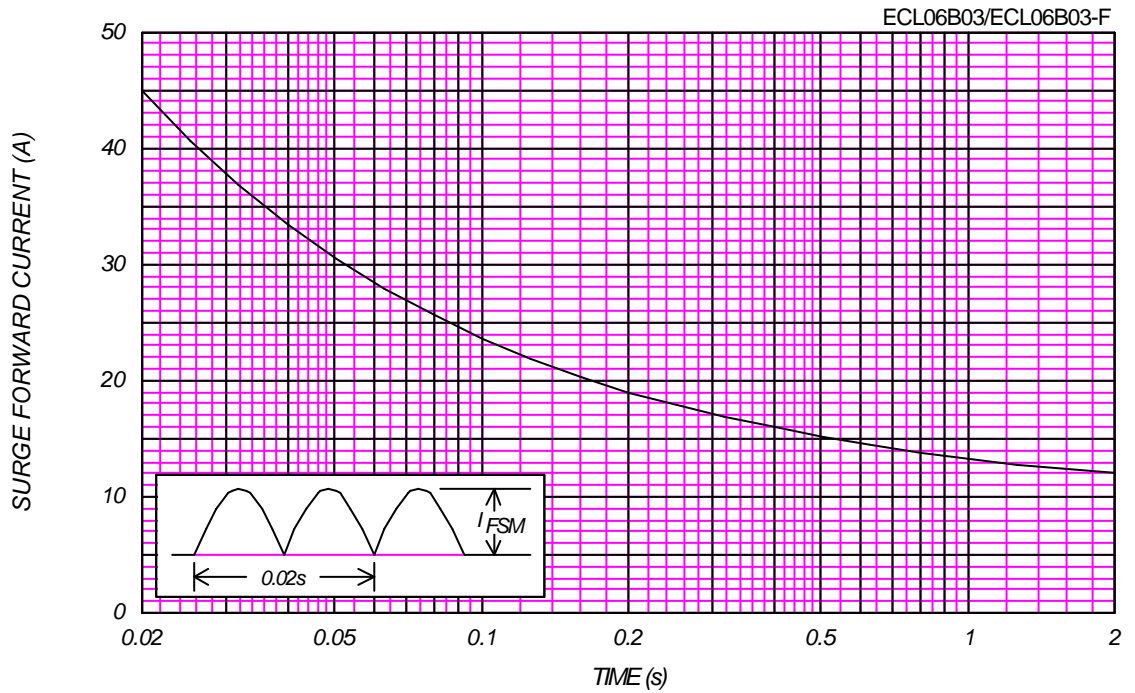

JUNCTION CAPACITANCE VS. REVERSE VOLTAGE

$T_j=25^\circ\text{C}$, $V_m=20\text{mV}_{\text{RMS}}$, $f=100\text{kHz}$, Typical Value

ECL06B03/ECL06B03-F (per Arm)

