

## Product Overview

NSPAS1 is a calibrated absolute pressure sensor series product launched by NOVOSENSE for vacuum boost, motorcycle MAP and Auto TMAP market. This series uses an automotive-grade ASIC to calibrate and compensate the MEMS sensor element, the pressure signal from 10kPa to 400kPa can be converted into an analog output signal (0~5V) with a customizable output range. While ensuring the reliability of the product, the two chips are integrated and packaged, reduces the package size greatly. This series provides outstanding performance in terms of initial accuracy and suits applications with harsh automotive temperature and stress conditions needing small drift over lifetime. Reliability test according to AEC-Q100 standard.

## Key Features

- High precision pressure sensing  
Better than  $\pm 1\%$ F.S. (0°C to 85°C)  
Better than  $\pm 1.5\%$ F.S. (-40°C to 125°C)
- Large temperature range (-40°C to 125°C)
- Over-voltage and Reverse voltage protection between -24V to 28V
- Directly supplied by high voltage up to 18V (absolute analog output)
- Better than 0.8ms response time
- Ratiometric/Absolute analog output
- Clamping
- AEC-Q100 qualified

## Applications

- Motorcycle applications (manifold air pressure measurement)
- Automotive applications (manifold air pressure measurement)
- Industrial control
- vacuum boost applications
- Battery pressure sensor
- Consumer applications
- Weather stations
- Altimeters

## Device Information

Part Number	Package	Body Size
NSPAS1	7373SOP8	7.30mm × 7.30mm

## Outline

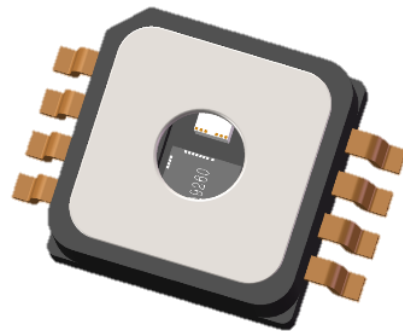

**INDEX**

1. PIN CONFIGURATION AND FUNCTIONS ..... 3

2. ABSOLUTE MAXIMUM RATINGS ..... 4

3. RECOMMENDED OPERATING CONDITIONS..... 4

4. SPECIFICATIONS ..... 5

    4.1. ELECTRICAL CHARACTERISTIC ..... 5

5. FUNCTION DESCRIPTION ..... 6

    5.1. OVERVIEW ..... 6

    5.2. TRANSFER FUNCTION..... 6

    5.3. ACCURACY ..... 7

    5.4. ALARM ..... 9

6. TYPICAL APPLICATION..... 9

    6.1. APPLICATION CIRCUIT ..... 9

    6.2. RECOMMENDED FOOTPRINT ..... 10

    6.3. SOLDERING PARAMETERS ..... 10

7. PACKAGE INFORMATION..... 11

8. ORDER INFORMATION ..... 12

9. IDENTIFICATION CODE ..... 13

10. PACKING INFORMATION ..... 13

11. REVISION..... 14

## 1. Pin Configuration and Functions

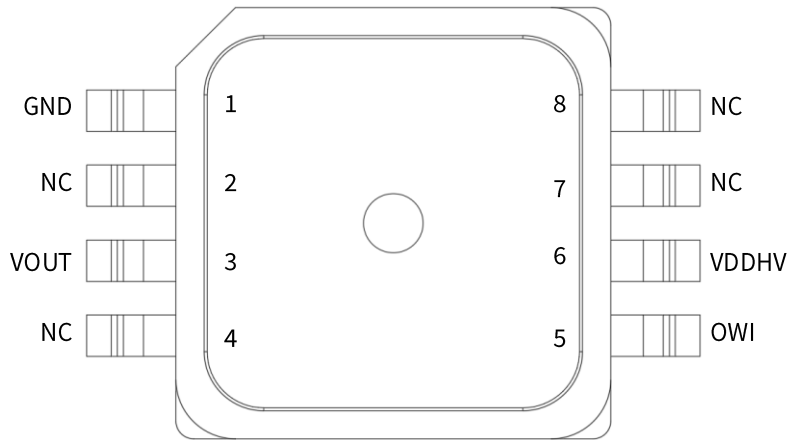

Fig 1.1 Pin Definition (Top view)

Table 1.1 Pin Description

<b>Pin NO.</b>	<b>Pin name</b>	<b>Description</b>
1	GND	Ground
2	NC	No connect
3	VOUT	Analog output
4	OWI	One wire interface (leave floating)
5	NC	No connect
6	VDDHV	Power supply with OVP/RVP
7	NC	No connect
8	NC	No connect

## 2. Absolute maximum ratings

Parameters	Symbol	Min	Typ	Max	Unit	Comments
Supply voltage	VDDHV	-24		28	V	70°C, 1 hour
		-30		36	V	70°C, 1 minute
Analog pin voltage	VOUT	-0.3		5.3	V	25°C, VDDHV>5V
Analog output current limit				25	mA	
Proof pressure	P <sub>proof</sub>	600			kPa	
Burst pressure	P <sub>burst</sub>	800			kPa	
ESD susceptibility	HBM	±2			kV	
	CDM	±500			V	
Storage temperature	Tstg	-40		150	°C	

## 3. Recommended Operating Conditions

Parameters	Symbol	Min	Typ	Max	Unit	Comments
Supply voltage	VDDHV	4.5	5	5.5	V	
Operating pressure	P <sub>amb</sub>	10		400	kPa	
Operating temperature	Topr	-40		125	°C	

## 4. Specifications

### 4.1. Electrical characteristic

Parameters	Symbol	Min	Typ	Max	Unit	Comments
Output voltage range	V <sub>OUT</sub>	0.01		4.99	V	
Accuracy pressure	Acc <sub>P</sub>	-1%		1%	%F.S.	@0°C ~85°C
		-1.5%		1.5%	%F.S.	@-40°C ~125°C
Power on reset	V <sub>D<sub>D</sub>HV<sub>POR</sub></sub>		2.5		V	
Operating current	I <sub>avdd</sub>	2.7	3.1	3.5	mA	
Output RMS noise	V <sub>rms</sub>		0.5		mV	
Output load resistance	R <sub>load</sub>	1			kOhm	
Output load capacitance	C <sub>load</sub>			150	nF	
Output short current limit	I <sub>short_lmt</sub>	10		25	mA	Output short to V <sub>D<sub>D</sub>HV</sub> or GND
Clamp high level	V <sub>clamp<sub>H</sub></sub>	50%		100%	%V <sub>D<sub>D</sub>HV</sub>	
Clamp low level	V <sub>clamp<sub>L</sub></sub>	0%		50%	%V <sub>D<sub>D</sub>HV</sub>	
Clamp level error	ΔV <sub>clamp</sub>	-40		40	mV	@V <sub>D<sub>D</sub>HV</sub> =5V
Power up time	T <sub>UP</sub>	8	10	13	ms	
Response time	T <sub>RESP</sub>			0.8	ms	
EEPROM data retention	T <sub>live</sub>	10			years	@125°C

## 5. Function description

### 5.1. Overview

NSPAS1 uses a MEMS piezoresistive absolute pressure sensor element as a pressure sensitive component that provide an original signal output that is proportional to ambient pressure. The built-in conditioning IC drives the sensitive component and amplifies, temperature compensates, and linearizes the original signal to output a voltage signal that is linear with the applied pressure.

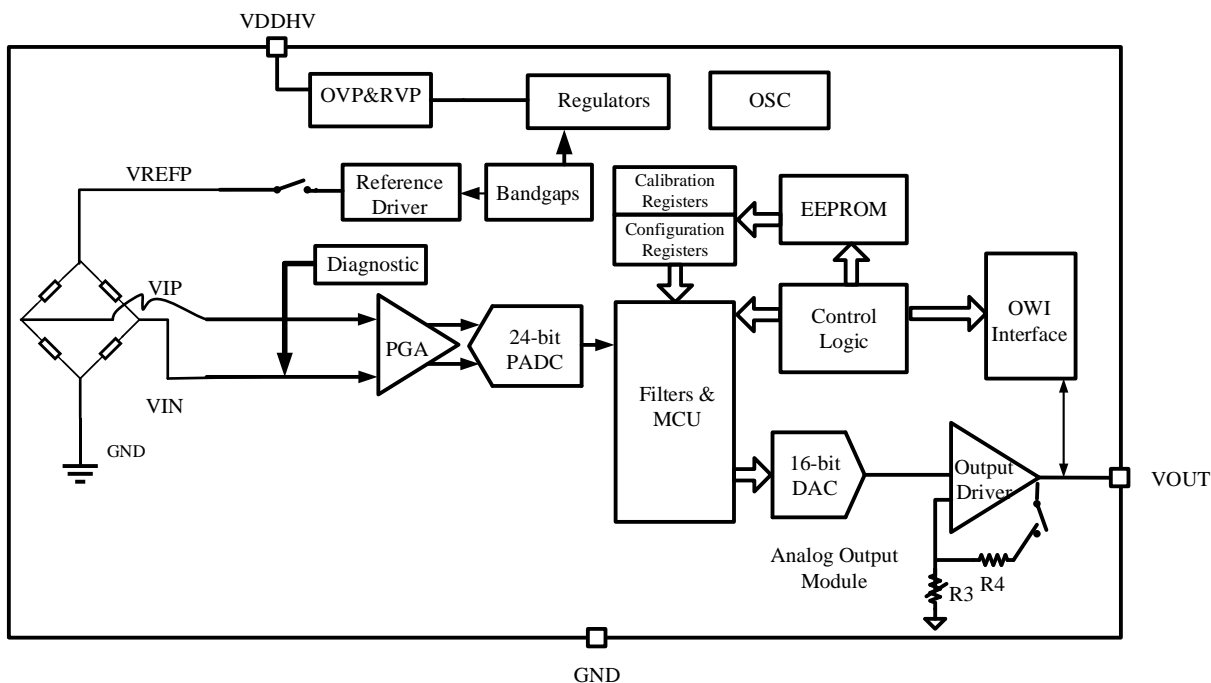

Fig 5.1 Product Function Block Diagram

### 5.2. Transfer function

NSPAS1 series device is fully calibrated on delivery. The sensor has a linear transfer function between the applied pressure and the output signal:

$$\text{Ratiometric: } V_{OUT} = (A \times P + B) \times V_{DDHV}$$

$$\text{Absolute: } V_{OUT} = (A \times P + B) \times 5$$

Note: 1) P is the pressure value, absolute pressure, range: 10kPe~400kPa; the transfer function is only established in the pressure range.

2) VDDHV must in the operating voltage range;

Table 5.1 NSPAS1N115RR01 transfer function coefficient

Product Type	Pressure Range		Output Range		Comments	
	$P_L$	$P_H$	$O_L$	$O_H$	A	B
NSPAS1N115RR01	10kPa	115kPa	0.4V	4.65V	0.008095	-0.00095

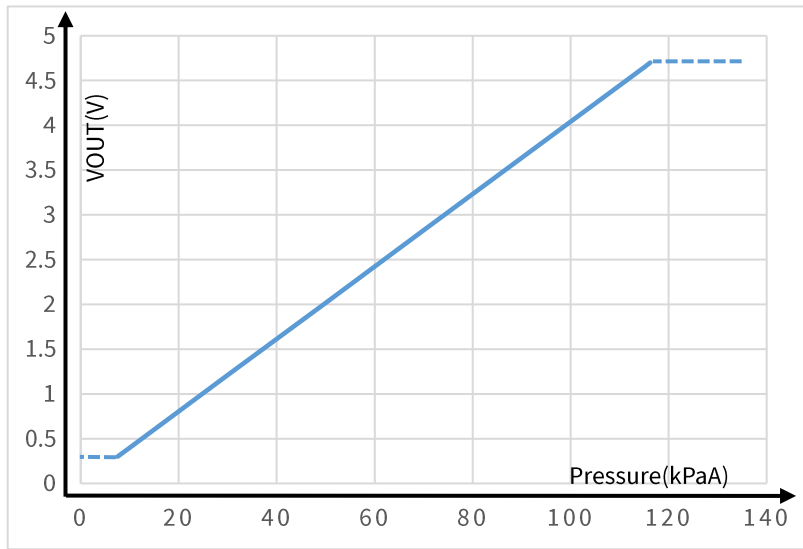

Fig 5.2 NSPAS1N115RR01 transfer function

### 5.3. Accuracy

Factors affecting the accuracy of NSPAS1 series products include power supply voltage (ratiometric error), pressure, temperature and aging effects. Standard output refers to the theoretical voltage output calculated by the transfer function of the pressure in the range. The error equals the deviation between the measured output voltage value and the specified output voltage value. The accuracy in the following analysis is in a typical application circuit.

#### 5.3.1 Ratiometric Error

Ideally the sensor is ratiometric - the output (VOUT) scales by the same ratio that VDDHV increases or decreases. The ratiometric error is defined as the difference between the ratio that VDDHV changed and the ratio that VOUT changed, expressed as a percentage. The calculation formula is as follows:

$$E_{RAT}(\%) = ( VOUT(@VDDHV) - VOUT(@5V) \times VDDHV/5V ) / 5V \times 100\%$$

The output voltage VOUT is ratiometric to VDDHV. VDDHV must be in the operating range.

Table 5.2 Ratiometric Output Error

Supply voltage (V)	Max. ratiometric error $E_{RAT}(\%)$ @ $VDDHV_{TYP}$
VDDHV <sub>MIN</sub>	±0.5%
VDDHV <sub>TYP</sub>	0
VDDHV <sub>MAX</sub>	±0.5%

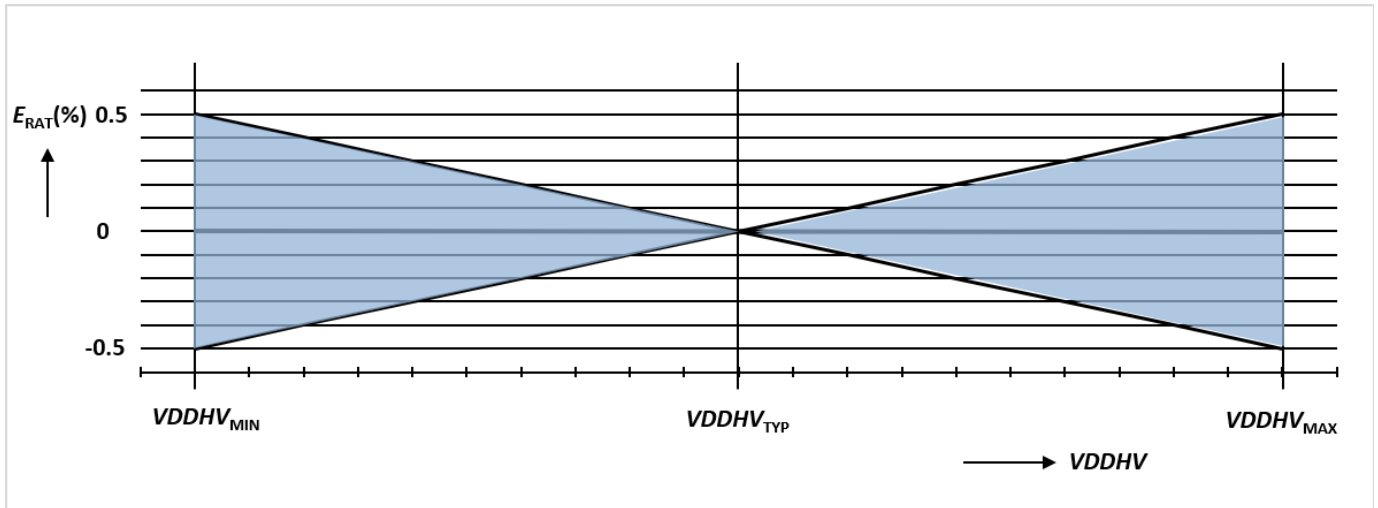

Fig 5.3 Ratiometric error

### 5.3.2 Overall Accuracy

The accuracy error includes errors introduced by all influencing factors within the operating range of pressure and temperature, including:

Pressure:

Output deviation from target transfer function over the specified pressure range

Temperature:

Output deviation over the temperature range

Aging:

Parameter drift over life time

Ps: Ratiometric signal error is not included in the overall accuracy. For error measurements, the supply voltage must have the nominal value ( $VDDHV = 5V$ ).

Table 5.3 Accuracy

Temperature (°C)	Error (%F.S.)
-40	1.50
0	1.00
85	1.00
125	1.50



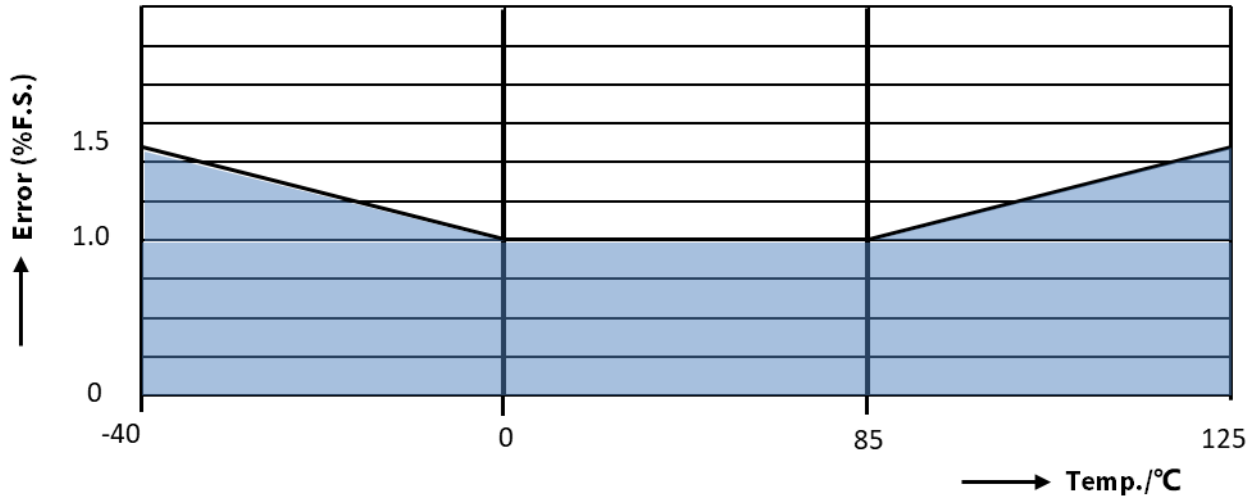

Fig 5.4 Accuracy for Pressure Acquisition

### 5.4. Alarm

NSPAS1 series have output alarm functions; when MEMS differential signal short to VDDHV/GND, the Vout will be pulled up to high voltage (4.9V@VDDHV=5V). The alarm function is OFF on default in order to optimize the response speed.

## 6. Typical Application

### 6.1. Application circuit

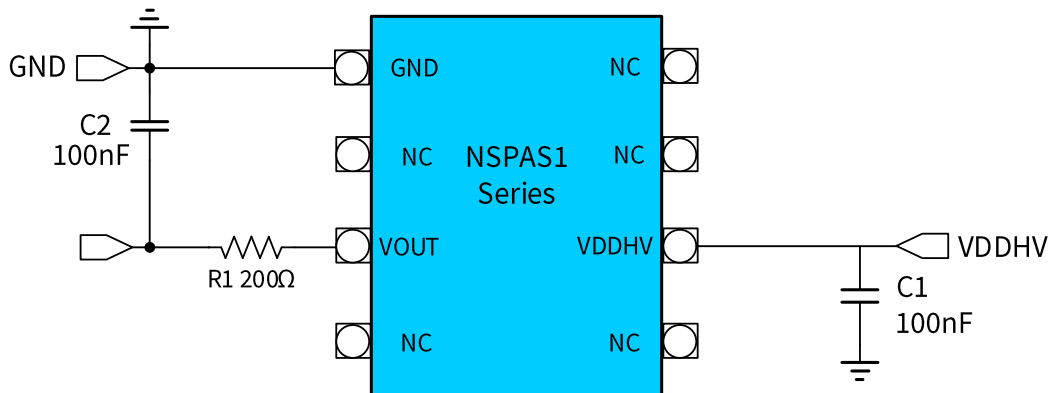

Fig 6.1 Application Circuit

Note :

- 1) For applications with higher ESD requirements, can add TVS between VOUT and GND and between VDDHV and GND.
- 2) Please contact NOVOSENSE for detailed peripheral recommended circuit.

6.2. Recommended footprint

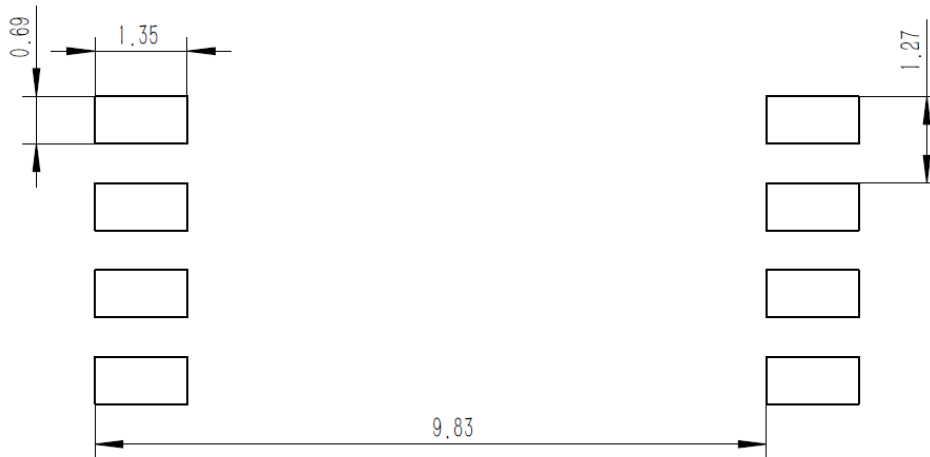

Fig 6.2 Footprint mm

6.3. Soldering Parameters

Table 6.1 Soldering Parameters

<i>Reflow Condition</i>		<i>Lead-free Assembly</i>
Pre Heat	Temperature Min (Ts(min))	150°C
	Temperature Max (Ts(max))	200°C
	Time (min to max) (ts)	60 – 180 secs
Average ramp up rate (Liquidus Temp (TL) to peak)		3°C/second max
Ts(max)to TL - Ramp-up Rate		3°C/second max
Reflow	Temperature (TL) (Liquidus)	217°C
	Time (min to max) (tl)	60 – 150 seconds
Peak Temperature (TP)		260°C
Time within 5°C of actual peak Temperature (tp)		20 – 40 seconds
Ramp-down Rate		6°C/second max
Time 25°C to peak Temperature (TP)		8 minutes Max.
Do not exceed		260°C

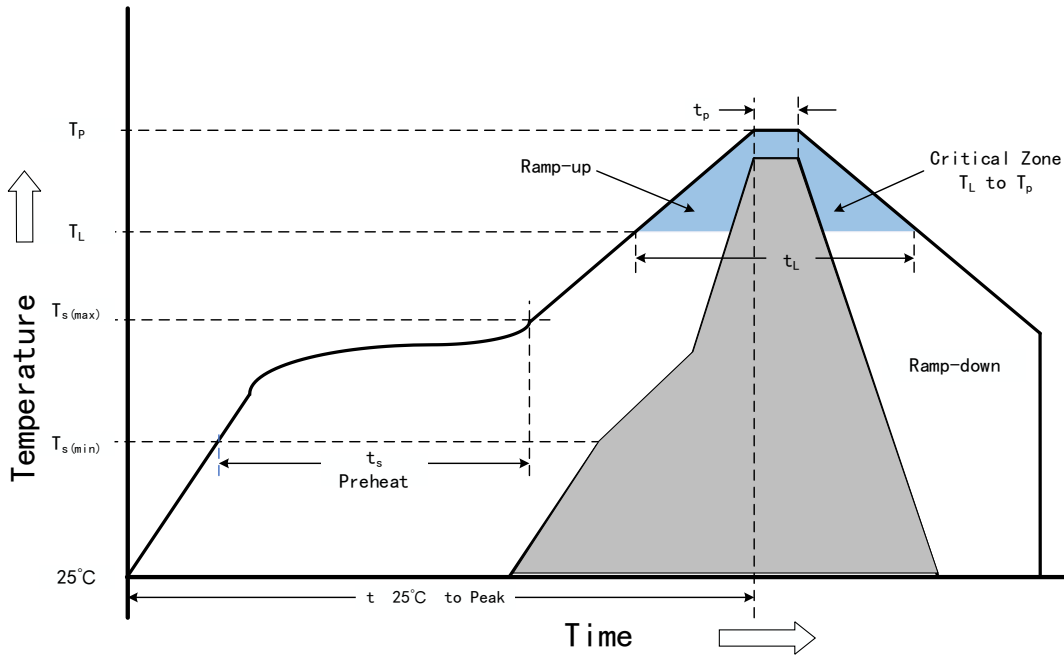

Fig 6.3 Soldering Profile

### 7. Package information

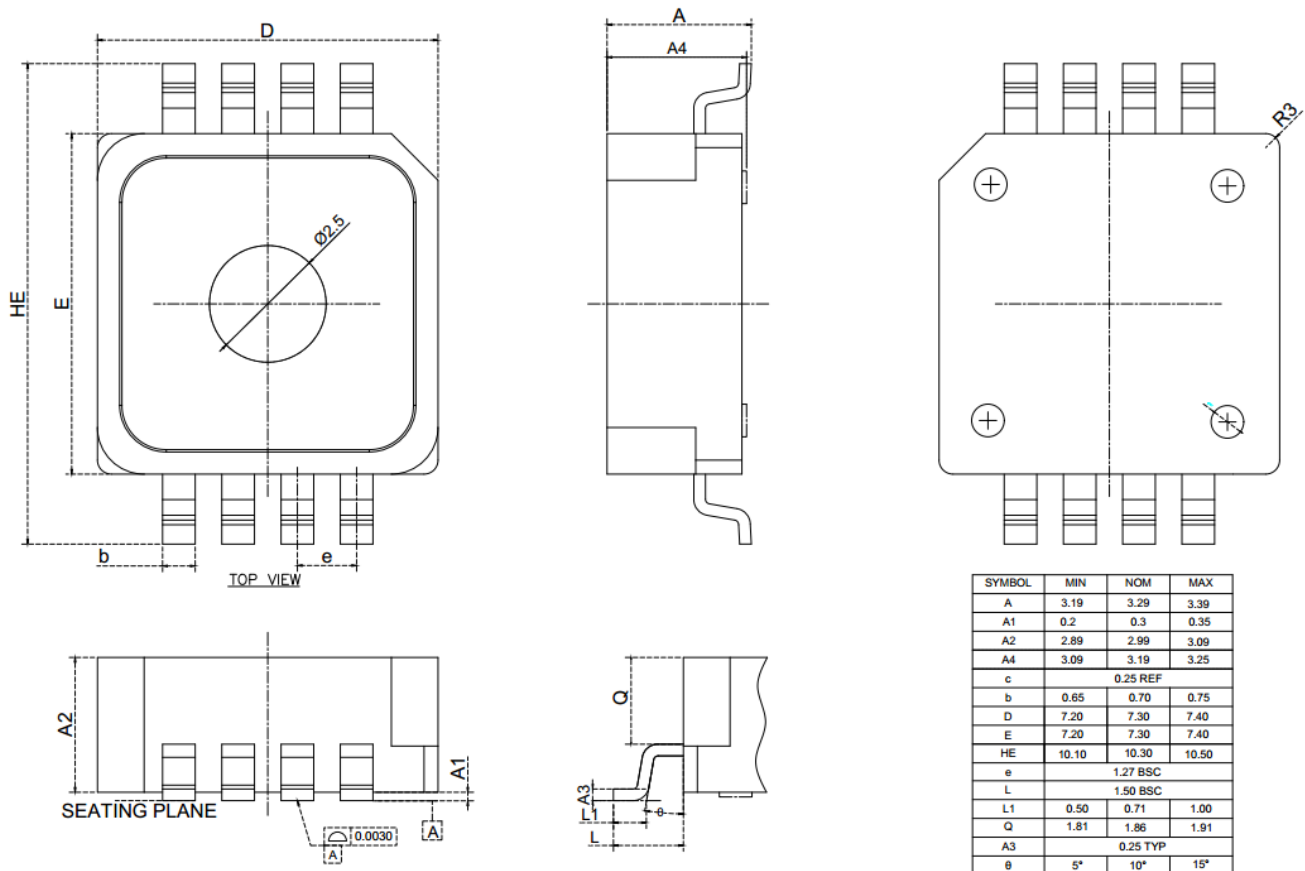

Fig 7.1 Package Outline mm

### 8. Order Information

Product Type	Output type	Pressure range		Output range		Clamp level		Gain and offset		Supply voltage
		P <sub>L</sub>	P <sub>H</sub>	O <sub>L</sub>	O <sub>H</sub>	V <sub>CL</sub>	V <sub>CH</sub>	A	B	
NSPAS1N115RR01	Ratiometric	10.00kPa	115.00kPa	0.400V	4.650V	6%	94%	0.008095	-0.000952	5.0V
NSPAS1N115RR02	Ratiometric	15.00kPa	115.00kPa	0.200V	4.700V	4%	94%	0.009000	-0.095000	5.0V
NSPAS1N300RR10	Ratiometric	50.00kPa	300.00kPa	0.400V	4.650V	0%	100%	0.003400	-0.090000	5.0V
NSPAS1N120RRA1	Ratiometric	13.33kPa	119.99kPa	1.000V	4.200V	0%	100%	0.006000	0.120002	5.0V
NSPAS1N200RR25	Ratiometric	80.00kPa	200.00kPa	0.250V	4.750V	5%	95%	0.007500	-0.550000	5.0V
NSPAS1N115RR27	Ratiometric	20.00kPa	115.00kPa	0.400V	4.650V	2%	97%	0.008947	-0.098947	5.0V
NSPAS1N165RRS1	Ratiometric	50.00kPa	165.00kPa	0.500V	4.500V	7%	94%	0.006957	-0.247826	5.0V
NSPAS1N400RR33	Ratiometric	50.00kPa	400.00kPa	0.500V	4.500V	6%	94%	0.002286	-0.014286	5.0V
NSPAS1N105RR35	Ratiometric	20.00kPa	105.00kPa	0.400V	4.650V	0%	100%	0.010000	-0.120000	5.0V
NSPAS1N350RR46	Ratiometric	44.80kPa	350.00kPa	0.500V	4.500V	5%	95%	0.002621	-0.017431	5.0V

Please scan the following QR code or visit the download link for complete part number list.

<https://www.novosns.com//Public/Uploads/uploadfile4/nspas1-series.pdf>



NSPAS1 Series

Naming Convention:

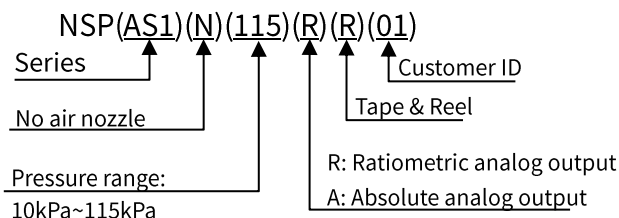

### 9. Identification Code

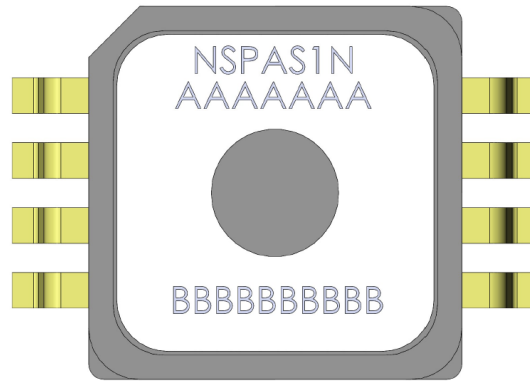

NSPAS1NAAAAAA: Product Type No.

BBBBBBBBBB: Date Code

### 10. Packing Information

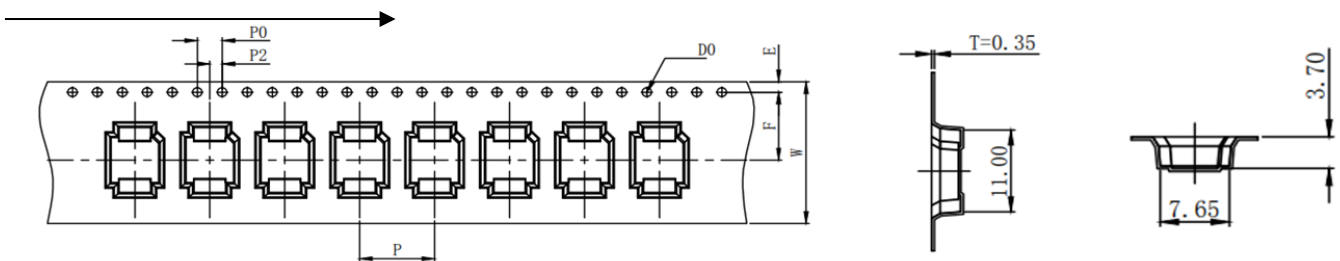

Part NO.	Package type	W (mm)	P0 (mm)	A0 (mm)	P (mm)	E (mm)	BO (mm)	F (mm)	P2 (mm)	KO (mm)	D0 (mm)	T (mm)
NSPAS1N165RRS1	SOP8	24±0.30	4±0.10	7.65±0.1	12±0.03	1.75±0.1	11±0.10	11.5±0.10	2±0.03	3.7±0.1	1.5±0.1	0.35±0.05

There is no component at the head and the tail of each tape/reel, where the space is 50cm, as shown in the following figure.

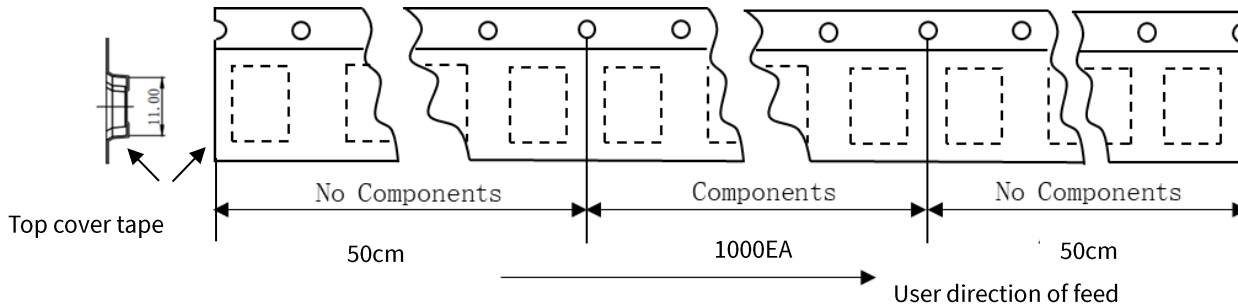

Pin1 is located at the second quadrant, as shown in the following figure.

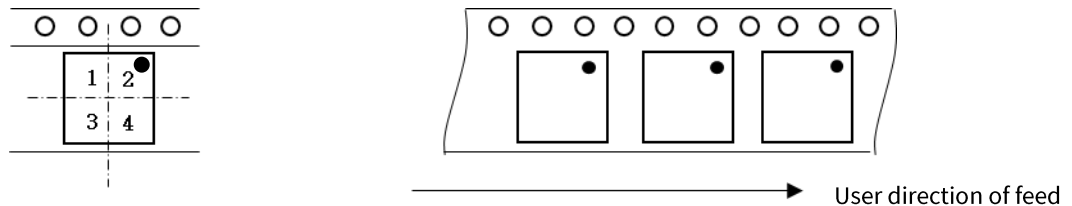

Minimum ordering quantity(MOQ):1000EA.

Standard pack quantity(SPQ): 1000EA

## 11. Revision

Revision	Description	Date
0.1	Initial Version.	2018/6/18
1.0	Formal release.	2018/12/8
2.0	Update the pin definition, block diagram, application circuit, outline drawing, package drawing packaging information.	2019/8/29
2.1	Part number update.	2020/3/6
2.2	Add clamping, diagnostic alarm function; ESD; Add power up time description.	2020/4/28
3.0	Change series naming rules.	2020/5/17
3.1	Add NSPAS1N135RT09、NSPAS1N300RT10 Part No.	2020/6/15
3.2	Add NSPAS1N120RTA1 Part No.	2020/7/8
3.3	Add NSPAS1N360RT11~NSPAS1N400RT21 Part No.	2020/12/28
3.4	Update format, font typical and application.	2021/2/7
3.5	Update format, LOGO.	2021/06/15
3.6	Update clamp voltage format; Update application circuit; Add soldering parameter; Add tape/reel package information	2022/05/11
3.7	Update pin description with OWI interface; Update order information; Remove tube packaging information	2023/01/31
3.8	Update order information and add barcode.	2023/04/21

## **IMPORTANT NOTICE**

The information given in this document shall in no event be regarded as a guarantee of any warranty or authorization, express or implied, including but not limited to merchantability, fitness for a particular purpose or infringement of any third party's intellectual property rights.

You are solely responsible for your use of Novosense' products and applications. You shall comply with all laws, regulations and requirements related to Novosense's products and applications, although information or support related to any application may still be provided by Novosense.

The resources are intended only for skilled developers designing with Novosense' products. Novosense reserves the rights to make corrections, modifications, enhancements, improvements or other changes to the products and services provided. Novosense authorizes you to use these resources for the development of relevant applications of Novosense's products, other reproduction and display of these resources is prohibited. Novosense shall not be liable for any claims, damages, costs, losses or liabilities arising out of the use of these resources.

For further information on applications, products and technologies, please contact Novosense ([www.novosns.com](http://www.novosns.com)).

Suzhou Novosense Microelectronics Co., Ltd