

## High Speed Single Low Side Driver

### FEATURES

- Output in Phase with Input
- Compatible with 3.3V and 5V Logic Input
- Input Voltages up to  $V_S$
- Under Voltage Lockout
- Additional OUT Pin
- Short Delay Time: 50ns at  $V_S = 15V$
- Output Rise and Fall Time of 25ns with 1000pF Load at  $V_S = 15V$
- Low Supply Current: 60 $\mu A$  at  $V_S = 15V$
- Leadfree, RoHS Compliant

### APPLICATIONS

- Switching Mode Power Supplies
- Motor Drivers
- General Purpose Single Low Side Drivers

### PRODUCT DESCRIPTION

The TS62273 is a single channel, high speed power MOSFET and IGBT driver, which is designed for applications that require low current signals to drive large capacitive loads with high speed. The input current is very low so that it is compatible with standard CMOS or LSTTL output. The output drivers feature a high pulse current buffer stage designed for minimum rise and fall time. Excellent latch immune performance is achieved.

### PIN CONFIGURATION

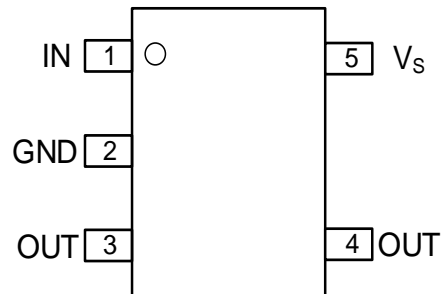

### BLOCK DIAGRAM

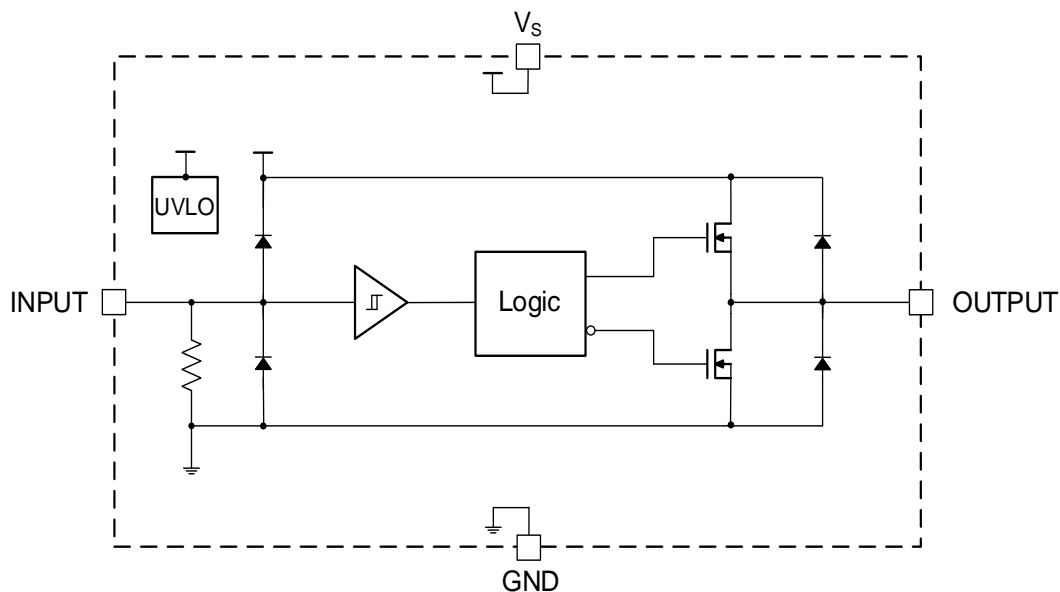

**ORDERING INFORMATION**

Product	Part Number	Eco Plan	Package	Container, Pack Qty
TS62273	TS62273SOT235LR	RoHS	SOT-23-5L	Reel, 3000

**RECOMMENDED OPERATING CONDITIONS**

Parameter	Min	Max	Unit
V <sub>CC</sub> to GND Voltage	12	20	V
Input Voltage	0	V <sub>s</sub>	V
Operating Temperature	-40	125	°C

**ABSOLUTE MAXIMUM RATINGS**

Over operating free-air temperature range (unless otherwise noted) <sup>(1)</sup>

Parameter	Min	Max	Unit
V <sub>s</sub> to GND Voltage	-0.3	20	V
Input Voltage	- 0.3	V <sub>s</sub> + 0.3	V
Output Voltage	- 0.3	V <sub>s</sub> + 0.3	V
Logic Input Voltage	- 0.3	V <sub>s</sub> + 0.3	V
Package Power Dissipation @ T <sub>A</sub> ≤ 50°C		120	mW
Thermal Resistance, Junction to Ambient		191	°C/W
Junction Temperature	-40	150	°C
Storage Temperature	-55	150	°C
Lead Temperature (Soldering, 10s)		300	°C
ESD HBM	±8kV Class 3B (JEDEC EIA/JESD22-A114)		
ESD MM	±300V Class B (JEDEC EIA/JESD22-A115)		
ESD CDM	±1500V Class C3 (JEDEC EIA/JESD22-C101F)		
IC Latch-Up Test	400mA @25°C Class II, Level A (JEDEC STANDARD NO.78E NOVEMBER 2016)		

**ESD CAUTION**



ESD (Electrostatic Discharge) sensitive device. Charged devices and circuit boards can discharge without detection. Although this product features patented or proprietary protection circuitry, damage may occur on devices subjects to high energy ESD. Therefore, proper ESD precautions should be taken to avoid performance degradation or loss of functionality.

(1) Stresses beyond those listed under “Absolute Maximum Ratings” may cause permanent damage to the device. This is a stress rating only and functional operation of the device at these or any other conditions beyond those indicated in the operational sections of this specification is not implied. Exposure to absolute maximum rating conditions for extended periods may affect device reliability.

**PIN CONFIGURATION**

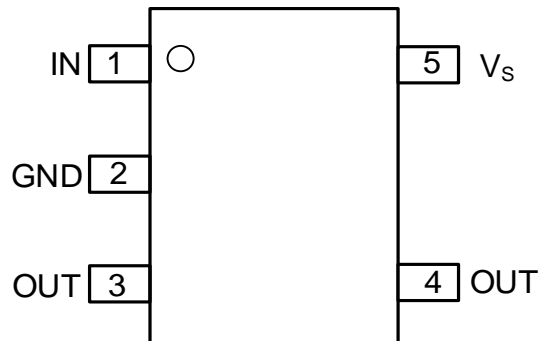

**PIN DEFINITIONS**

Pin No.	Symbol	Function
1	IN	Input (with 1MΩ pull-down resistor)
2	GND	Ground
3	OUT	Output
4	OUT	Output
5	V <sub>s</sub>	Power Supply

**FUNCTION TABLE**

Input	Output
L	L
H	H

## ELECTRICAL CHARACTERISTICS

At  $T_A = +25^\circ\text{C}$ , and  $V_S = 15\text{V}$  (unless otherwise noted)

Parameter		Operating Conditions	Min	Typ	Max	Unit
<b>Input Characteristics</b>						
$V_{IH}$	Logic 1 Input Voltage		2.5			V
$V_{IL}$	Logic 0 Input Voltage				0.8	
$I_{IN+}$	Logic 1 Input Current	$I_N = 5\text{V}$		5	15	$\mu\text{A}$
$I_{IN-}$	Logic 0 Input Current	$I_N = 0\text{V}$		0		
<b>Output Characteristics</b>						
$V_{OH\_0mA}$	High Output Voltage	$I_{OUT} = 0\text{mA}$	13.2			V
$V_{OH\_20mA}$		$I_{OUT} = 20\text{mA}$		13.0		
$V_{OH\_60mA}$		$I_{OUT} = 60\text{mA}$		12.6		
$V_{OH\_200mA}$		$I_{OUT} = 200\text{mA}$		11.7		
$V_{OL\_20mA}$	Low Output Voltage	$I_{OUT} = 20\text{mA}$			0.15	V
$V_{OL\_60mA}$		$I_{OUT} = 60\text{mA}$		0.06		
$V_{OL\_200mA}$		$I_{OUT} = 200\text{mA}$		0.25		
$I_{O+}$	Peak Output Current	$I_N = 5\text{V}, I_{OUT} = 0\text{V}$		2.3		A
$I_{O-}$		$I_N = 0\text{V}, I_{OUT} = V_{CC}$		3.3		
<b>Power Supply</b>						
$I_{Q+}$	Quiescent Supply Current	$I_N = 5\text{V}$		60	120	$\mu\text{A}$
$I_{Q-}$		$I_N = 0\text{V}$		45	100	
$ULVO+$	$V_S$ Under Voltage Lockout Exit <sup>[1]</sup>			10		V
$ULVO-$	$V_S$ Under Voltage Lockout Enter <sup>[2]</sup>			9		
$V_{S\_Clamp}$	$V_S$ Zener Clamp Voltage	$I_{Q+} = 5\text{mA}$		22.0		V
<b>Switching Time Characteristics</b>						
$t_{on}$	Turn-on Propagation Delay	Refer to Figure 2 & Figure 3		50	95	ns
$t_{off}$	Turn-off Propagation Delay			50	95	
$t_r$	Output Rise Time			25	55	
$t_f$	Output Fall Time			25	55	

NOTE:

[1]  $V_{CC}$  From Low to High

[2]  $V_{CC}$  From High to Low

**TYPICAL CHARACTERISTICS**

At  $T_A = +25^\circ\text{C}$ ,  $C_{\text{LOAD}} = 1\text{nF}$ , and  $V_S = 15\text{V}$  (unless otherwise noted)

**Supply Current vs Supply Voltage**

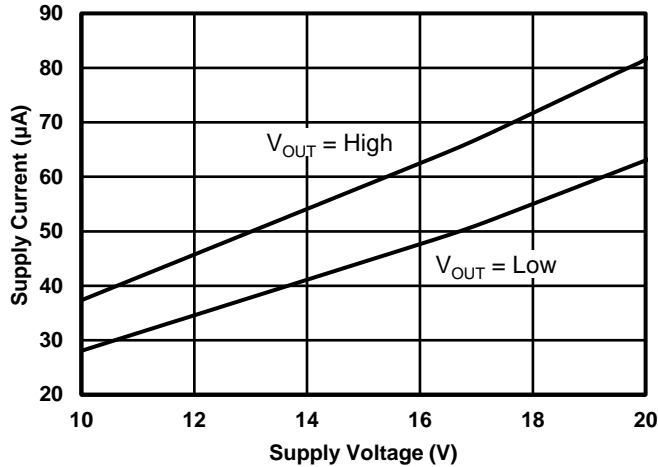

**Supply Current vs Temperature**

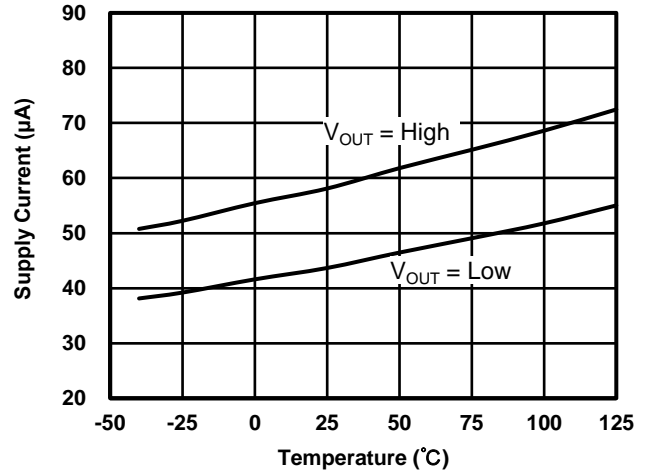

**Input Current vs Input Voltage**

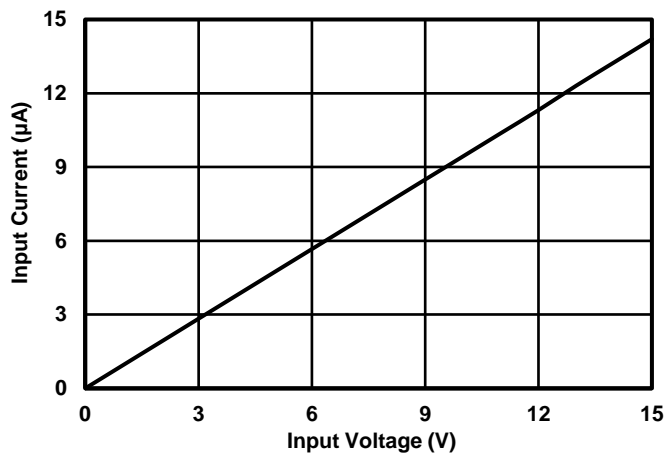

**Logic Input Threshold Voltage vs Temperature**

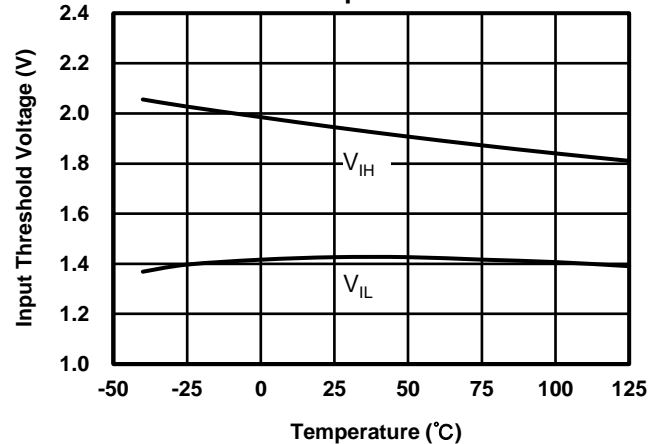

**Output Source Saturation Voltage vs Temperature**

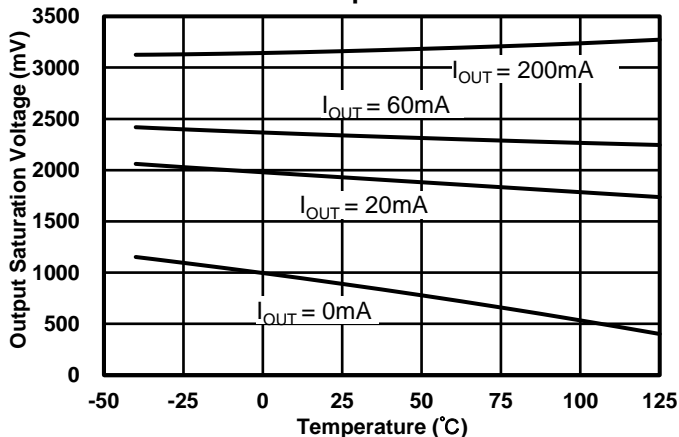

**Output Sink Saturation Voltage vs Temperature**

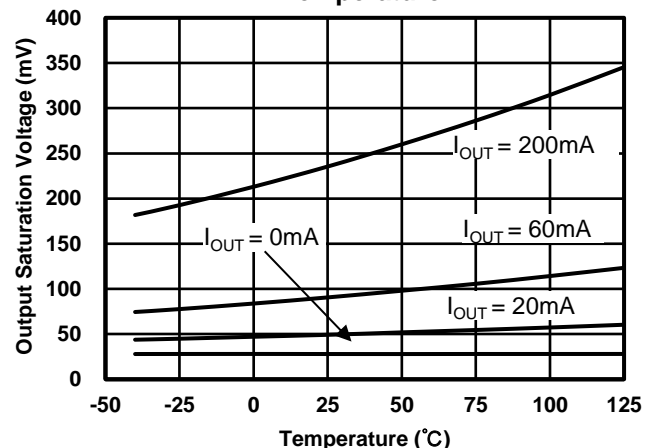

**TYPICAL CHARACTERISTICS(CONTINUE)**

At  $T_A = +25^\circ\text{C}$ ,  $C_{\text{LOAD}} = 1\text{nF}$ , and  $V_S = 15\text{V}$  (unless otherwise noted)

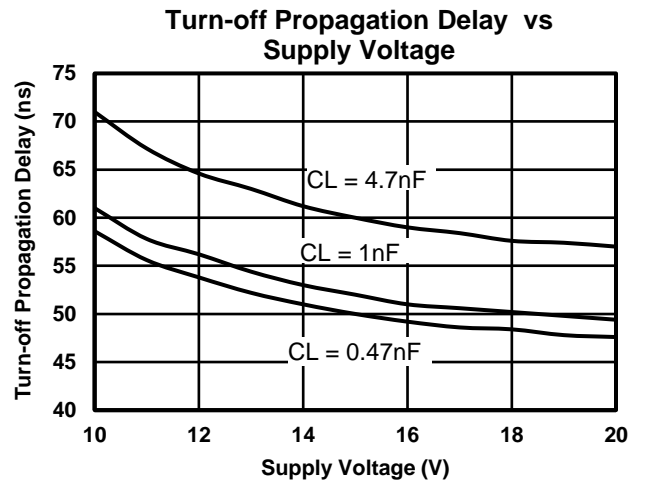
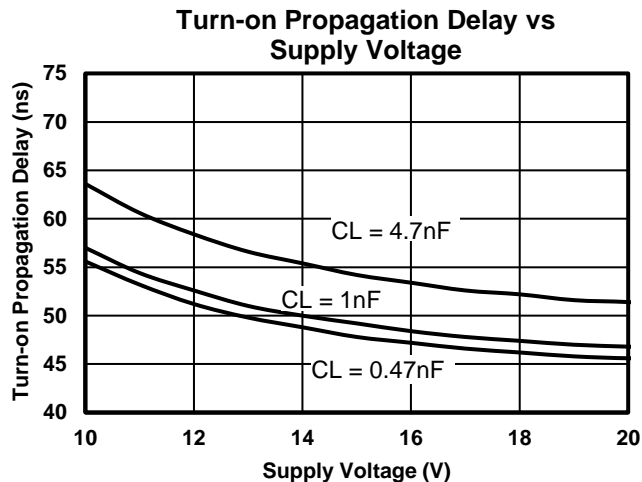
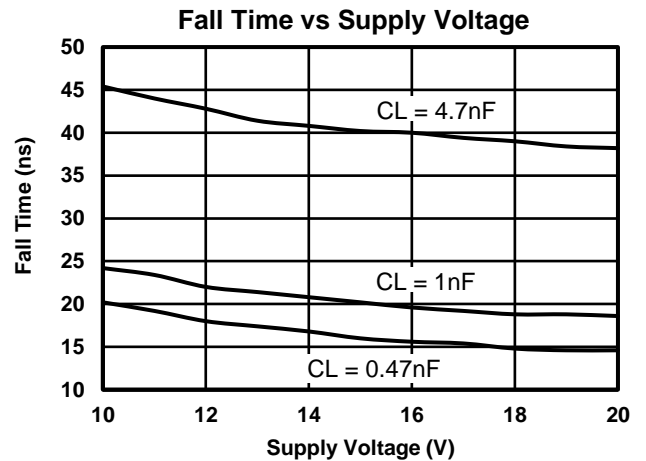
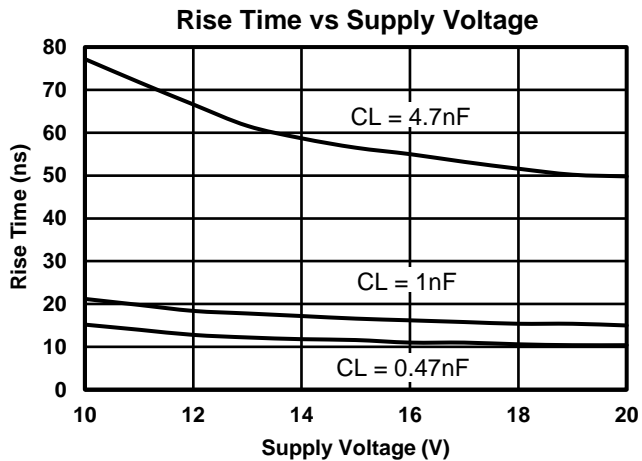
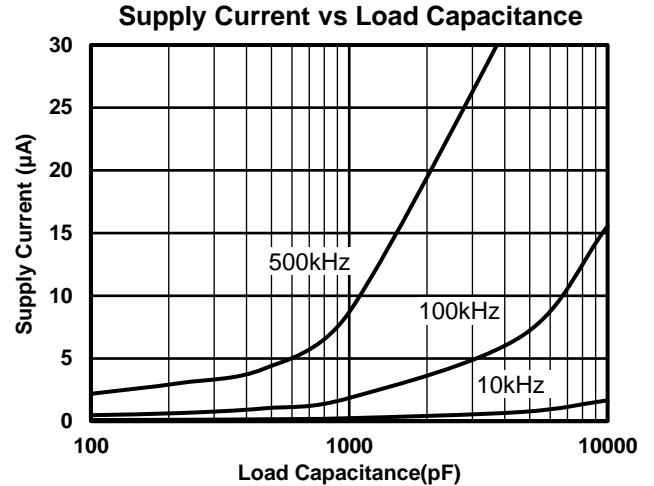
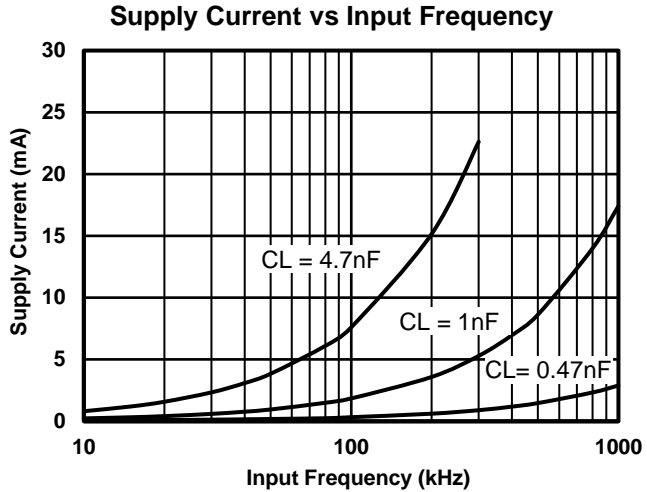

**TYPICAL CHARACTERISTICS**

At  $T_A = +25^\circ\text{C}$ ,  $C_{\text{LOAD}} = 1\text{nF}$ , and  $V_S = 15\text{V}$  (unless otherwise noted)

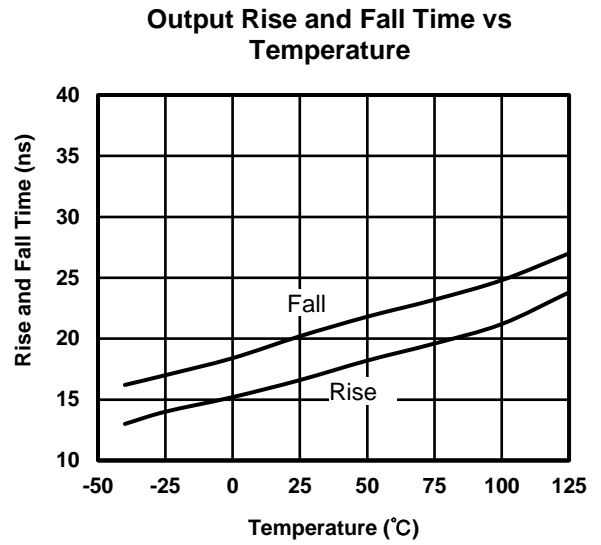
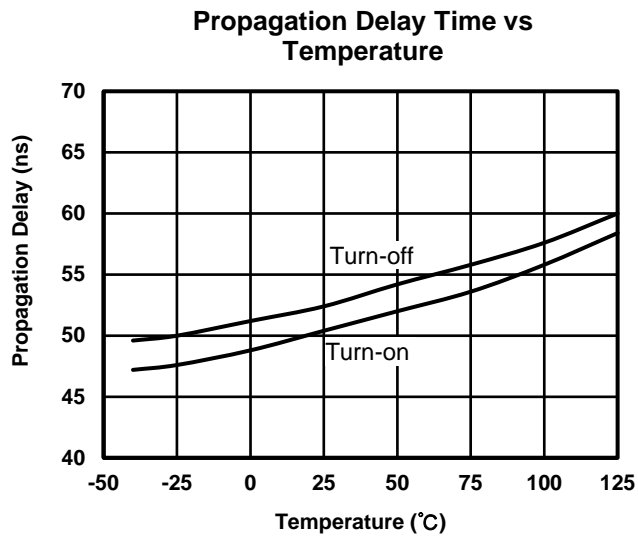

**APPLICATION NOTES & ADDITIONAL DETAILS**

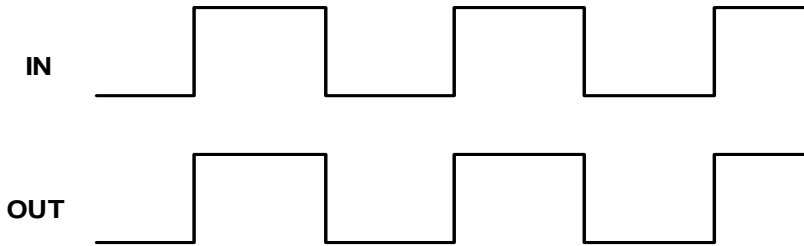

Figure 1. Input / Output Timing Diagram

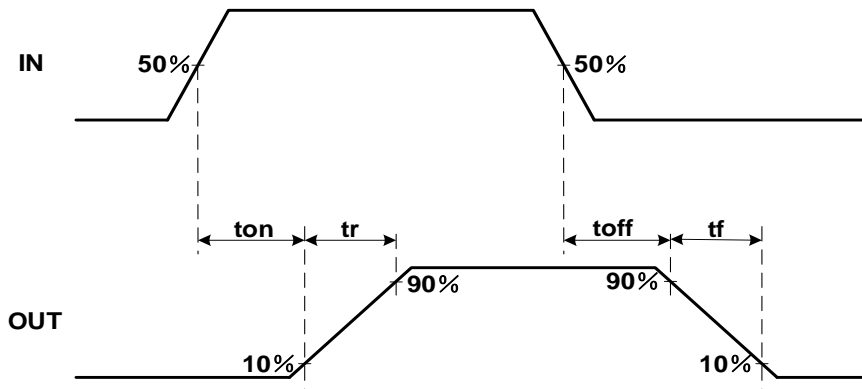

Figure 2. Switching Time Waveform Definitions

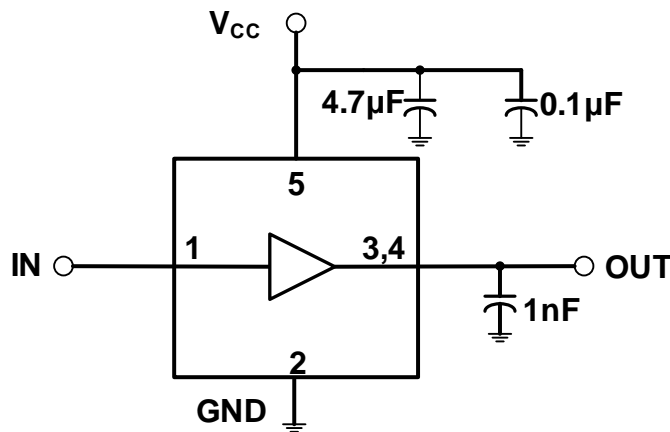
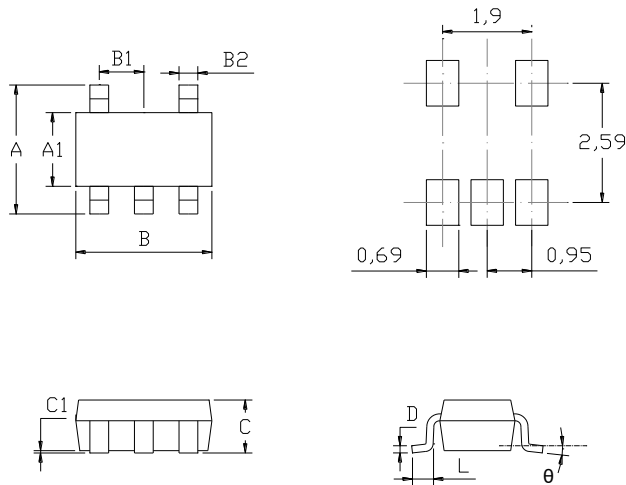

Figure 3. Test Circuit for Switching Time



**MECHANICAL DIMENSIONS**

**SOT-23-5L PACKAGE MECHANICAL DRAWING**



**SOT-23-5L PACKAGE MECHANICAL DATA**

symbol	dimensions			
	millimeters		inches	
	min	max	min	max
A	2.650	2.950	0.104	0.116
A1	1.500	1.700	0.059	0.067
B	2.820	3.020	0.111	0.119
B1	0.950		0.037	
B2	0.300	0.500	0.012	0.020
C		1.250		0.049
C1	0	0.100	0.000	0.004
L	0.300	0.600	0.012	0.024
D	0.100	0.200	0.004	0.008
theta	0°	8°	0°	8°

**TAPE AND REEL INFORMATION**

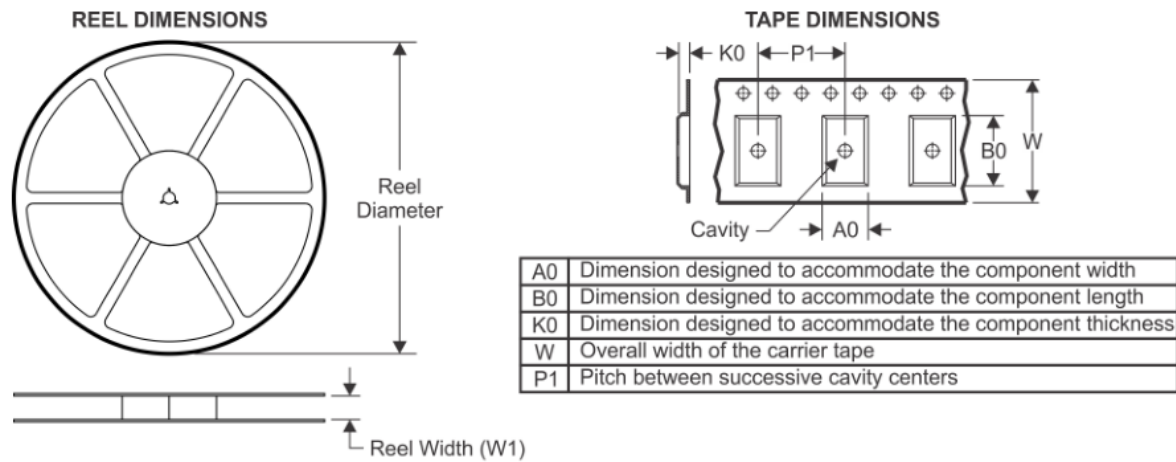

**QUADRANT ASSIGNMENTS FOR PIN 1 ORIENTATION IN TAPE**

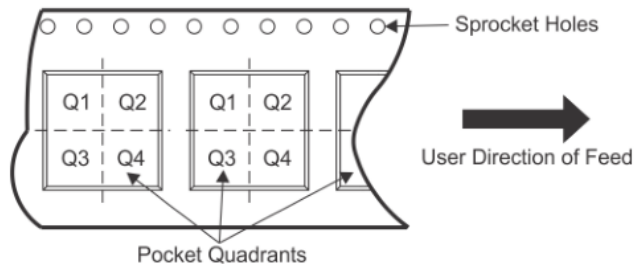

Device	Package Type	Pins	SPQ	Reel Diameter (mm)	Reel Width W1 (mm)	A0 (mm)	B0 (mm)	K0 (mm)	P1 (mm)	W (mm)	Pin1 Quadran
TS62273SOT235LR	SOT-23-5L	5	3000	180.0	9.0	3.2	3.3	1.4	4.0	8.0	Q3

---

## **REVISION HISTORY**

NOTE: Page numbers for previous revisions may be different from that of the current version.

**2020/9/4 — REV KY1.0.1A to REV KY1.0.2A**

Added notice to ABSOLUTE MAXIMUM RATINGS .....	2
Updated the format of ELECTRICAL CHARACTERISTICS .....	3

**2020/7/8 — REV KY1.0.2A TO REV KY1.1.2A**

Updated ABSOLUTE MAXIMUM RATINGS .....	2
Add REVISION HISTORY .....	11

**2020/7/16 — REV KY1.1.2A TO REV KY1.2.2A**

Updated ABSOLUTE MAXIMUM RATINGS .....	2
--	---

## CONTACT INFORMATION

Trusignal Microelectronics

Phone: +86 512-65923982

Fax: +86 512-65923995

Email: [support@kunyuanic.com](mailto:support@kunyuanic.com); [sales@kunyuanic.com](mailto:sales@kunyuanic.com)