

BTA04/BTB04

TO-220

Triac Series

Absolute maximum ratings

Parameter	Symbol	Value	Unit	Test condition
peak repetitive off-stage voltage	V_{DRM}, V_{RRM}	600	V	
on-state RMS current	$I_T(RMS)$	4	A	$T_C \leq 105^\circ C$
NON repetitive surge peak on-state current	I_{TSM}	35	A	$T_p=20ms, T_j=25^\circ C, F=50HZ$
critical rate of rise on-state current	$di/dt (Q_{1-3})$	50	A/ μs	
peak gate current	I_{GM}	4	A	
average gate power dissipation	$P_G(AV)$	0.5	W	
storage temperature range	T_{stg}	-40 to +150	$^\circ C$	
operating junction temperature range	T_j	125	$^\circ C$	

Electrical characteristics ($T_j=25^\circ C$) unless otherwise specified

Parameter	Symbol	Value	Unit	Test condition
gate trigger current	I_{GT}	≤ 50	mA	T2+G+ $V_D=12V, I_T=0.1A$
		≤ 50	mA	T2+G- $V_D=12V, I_T=0.1A$
		≤ 50	mA	T2-G- $V_D=12V, I_T=0.1A$
		≤ 100	mA	T2-G+ $V_D=12V, I_T=0.1A$
gate trigger voltage	V_{GT}	≤ 1.30	V	$V_D=12V, I_T=0.1A$
hold current	I_H	≤ 25	mA	$I_T=0.5A$
critical rate of rise off-state voltage	dv/dt	≥ 10	V/ μs	$V_D=67\%V_{DRM}$
on-state voltage	V_{TM}	≤ 1.65	V	$I_T=5.5A$
off-state leakage current	I_{DRM}	≤ 1.00	mA	$V_D=V_{DRM}; T_j=125^\circ C$
thermal resistance	$R_{th(j-a)}$	60	$^\circ C/W$	
	$R_{th(j-c)} AC$	≤ 4.40		BTA Insulated
	$R_{th(j-c)} AC$	≤ 3.20		BTB Uninsulated

Disclaimer

The product information and the selection guides facilitate selection of the CDIL's Discrete Semiconductor Device(s) best suited for application in your product(s) as per your requirement. It is recommended that you completely review our Data Sheet(s) so as to confirm that the Device(s) meet functionality parameters for your application. The information furnished in the Data Sheet and on the CDIL Web Site/CD are believed to be accurate and reliable. CDIL however, does not assume responsibility for inaccuracies or incomplete information. Furthermore, CDIL does not assume liability whatsoever, arising out of the application or use of any CDIL product; neither does it convey any license under its patent rights nor rights of others. These products are not designed for use in life saving/support appliances or systems. CDIL customers selling these products (either as individual Discrete Semiconductor Devices or incorporated in their end products), in any life saving/support appliances or systems or applications do so at their own risk and CDIL will not be responsible for any damage resulting from such sale(s).

CDIL strives for continuous improvement and reserves the right to change the specifications of its products without prior notice.



CDIL is a registered Trademark of

Continental Device India Limited

C-120 Naraina Industrial Area, New Delhi 110 028, India.

Telephone + 91-11-2579 6150, 4141 1112 Fax + 91-11-2579 5290, 4141 1119

email@cdil.com www.cdilsemi.com

PACKAGE TO-220 AB

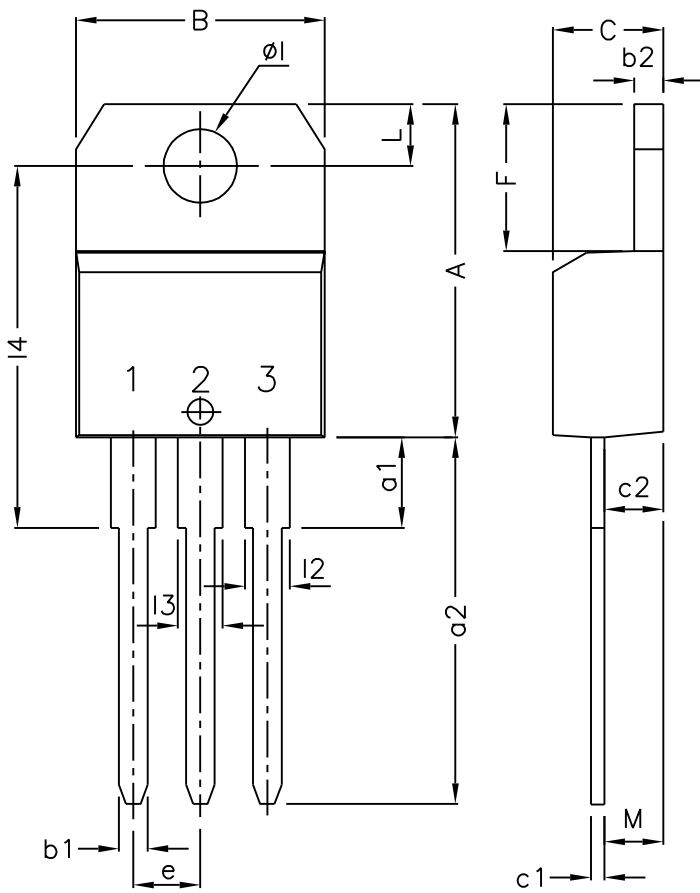

DIM	MIN	TYP.	MAX
A	15.20		15.90
a1		3.75	
a2	13.00		14.00
B	10.00		10.40
b1	0.61		0.88
b2	1.23		1.32
C	4.40		4.60
c1	0.49		0.70
c2	2.40		2.72
e	2.40		2.70
F	6.20		6.60
l	3.75		3.85
l4	15.80	16.40	16.80
L	2.65		2.95
l2	1.14		1.70
l3	1.14		1.70
M		2.60	

ALL DIMENSIONS ARE IN mm

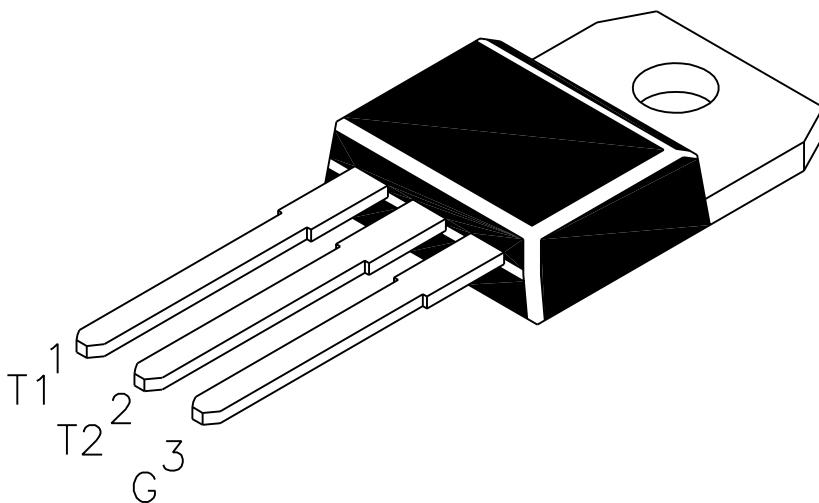

PIN CONFIGURATION:—

1. MAIN TERMINAL 1
2. MAIN TERMINAL 2
3. GATE