

MINIATURE SIGNAL RELAY EC2(ND),EE2(ND) SERIES

High Insulation, High breakdown voltage, compact and lightweight,
Surface mounting type

DESCRIPTION

NEC EC2 (ND) / EE2 (ND) series has based supplementary insulation for EN60950. (TUV Certified File No. R9750561)

FEATURES

- Insulation distance : more than 2 mm
- Distance through insulation : more than 0.4 mm
- Applicable for the surge voltage standard of FCC (1500 V, $10 \times 160 \mu\text{s}$) and BELLCORE (2500 V, $2 \times 10 \mu\text{s}$)
- Two types for through-hole mounting (EC2 (ND) series) and surface mounting (EE2 (ND) series)

APPLICATIONS

Electronic switching systems, facsimile, modems, terminal equipment.

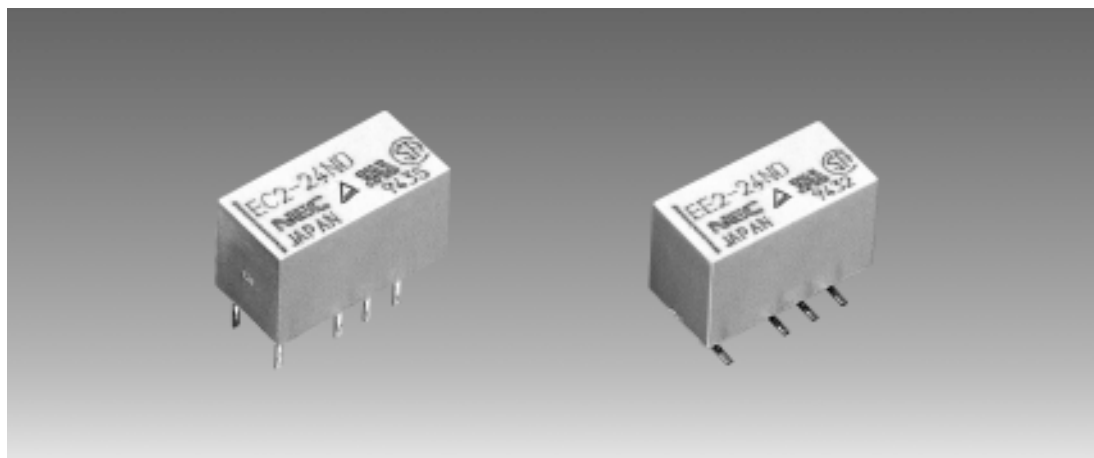

For Right Use of Miniature Relays

DO NOT EXCEED MAXIMUM RATINGS.

Do not use relays under exceeding conditions such as over ambient temperature, over voltage and over current. Incorrect use could result in abnormal heating, damage to related parts or cause burning.

READ CAUTIONS IN THE SELECTION GUIDE.

Read the cautions described in NEC's "Miniature Relays" (ER0046EJ*) when you choose relays for your application.

The information in this document is subject to change without notice.

DIMENSIONS AND PAD LAYOUTS (Unit : mm (inch))

EC2 (ND) SERIES

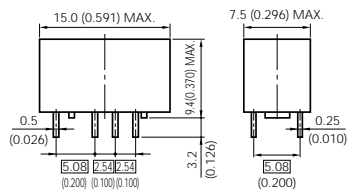

Note. General tolerance : ± 0.2 (± 0.008)
Dimensions in show basic size.

Non-latch and Single coil latch

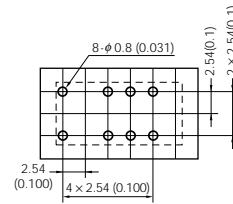

(Bottom view)

Note. General tolerance : ± 0.1 (± 0.004)

EE2 (ND) SERIES

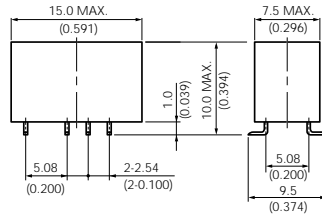

Note 1. General tolerance : ± 0.2 (± 0.008)

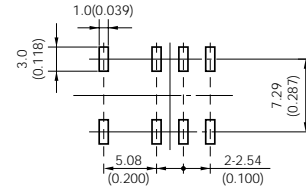

(Bottom view)

Note 1. General tolerance : ± 0.1 (± 0.004)

PIN CONFIGURATIONS (bottom view)

EC2 (ND) SERIES

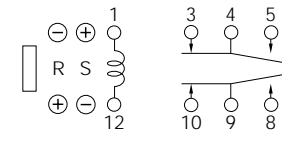
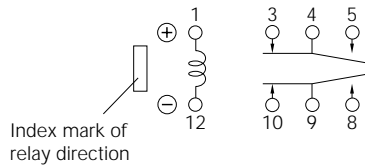

S : Coil polarity of set (operate)
R : Coil polarity of reset (release)

EE2 (ND) SERIES

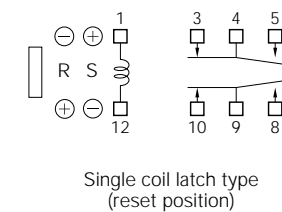
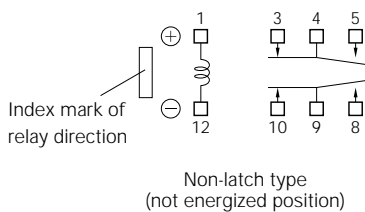

S : Coil polarity of set (operate)
R : Coil polarity of reset (release)

MARKINGS (top view)

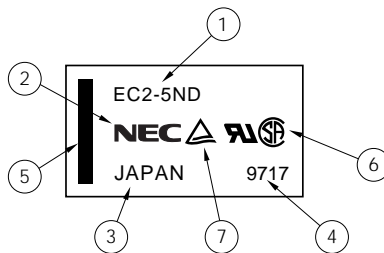

- ① Part number
- ② Manufacturer
- ③ Country of origin
- ④ Date code
- ⑤ Index mark of relay direction (pin No. 1, 12)
- ⑥ UL, CSA Marking
- ⑦ TUV Marking

PERFORMANCE CHARACTERISTICS

Contact Form		2 Form c	
Contact Ratings (UL / CSA Rating)	Maximum Switching Power	60 W (resistive)	125 VA (resistive)
	Maximum Switching Voltage	220 Vdc	250 Vac
	Maximum Switching Current	2 A	
	Maximum Carrying Current	2 A	
Minimum Contact Ratings		10 mVdc, 10 μ A *1	
Initial Contact Resistance		50 m Ω typ. (Initial)	
Contact Material		Silver alloy with gold overlay	
Nominal Operating Power	Non-Latch Type	200 to 230 mW	
	Single Coil Latch Type	100 to 170 mW	
Operate Time (Excluding Bounce)		Approximately 2 ms without diode	
Release Time (Excluding Bounce)		Approximately 1 ms without diode	
Insulation Resistance		1000 M Ω at 500 Vdc	
Breakdown Voltage	Between Open Contacts	1000 Vac for one minute (1500 V surge, 10 \times 160 μ s *2)	
	Between Adjacent Contacts	1000 Vac for one minute (1500 V surge, 10 \times 160 μ s *2)	
	Between Coil and Contact	1500 Vac for one minute (2500 V surge, 2 \times 10 μ s *3)	
Shock Resistance		735 m/s ² (75 G) (misoperating) 980 m/s ² (100 G) (destructive failure)	
Vibration Resistance		10 to 55 Hz at double amplitude of 3 mm (20 G) (misoperating) 10 to 55 Hz, double amplitude of 5 mm (30 G) (Destructive failure)	
Ambient Temperature		-40 to 85°C (-40 to 185°F)	
Coil Temperature Rise		25 degrees at nominal coil voltage (200 mW)	
Running specifications	No-load	1 \times 10 ⁸ operations (Non-latch type) *4	
		1 \times 10 ⁷ operations (latch type)	
	Load	50 Vdc 0.1 A (resistive), 1 \times 10 ⁶ operations at 85°C	
		10 Vdc 10 mA (resistive), 1 \times 10 ⁶ operations at 85°C	
Weight		Approximately 1.9 grams	

- *1 This value is reference value in the resistance load.
Minimum capacity changes depending on switching frequency and environment temperatur and the load.
- *2 rise time : 10 μ s, fall time : 160 μ s
- *3 rise time : 2 μ s, fall time : 10 μ s
- *4 This shows a number of operation where it can be running by which a fatal defect is not caused, and a number of operation by which a steady characteristic is maintained is 1 \times 10⁷ times.

PART NUMBER SYSTEM

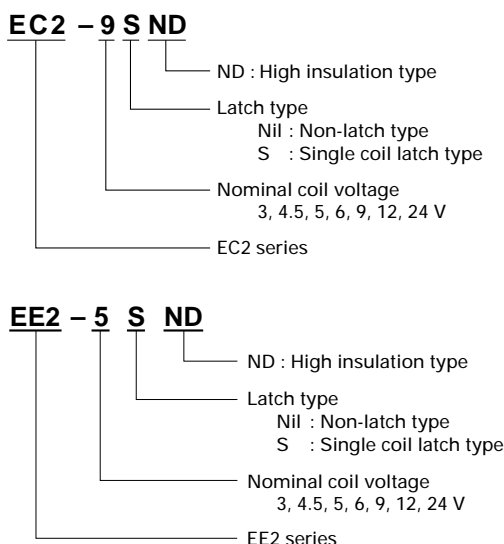

SAFETY STANDARD AND RATING

UL Recognized (UL508)* File No E73266	CSA Certified (CSA C22.2 No 14) File No LR46266
30 Vdc, 2A (Resistive) 110 Vdc, 0.3A (Resistive) 125 Vdc, 0.5A (Resistive)	

* Spacing : UL114, UL478

TUV Certificate (EN60255 / IEC60255) No. R 9750561
Creepage and clearance of coil to contact is over than 2 mm. (According EN60950 working-voltage 250 V)
Supplementary insulation class

NOMINAL LINEUP

Non-latch Type

at 20°C

Nominal Coil Voltage (Vdc)	Coil Resistance (Ω) $\pm 10\%$	Must Operate Voltage *	Must Release Voltage *	Nominal operate power (mW)
3	45	2.25	0.3	200
4.5	101	3.38	0.45	200
5	125	3.75	0.5	200
6	180	4.5	0.6	200
9	405	6.75	0.9	200
12	720	9	1.2	200
24	2504	18	2.4	230

Single-Coil Latch Type

at 20°C

Nominal Coil Voltage (Vdc)	Coil Resistance (Ω) $\pm 10\%$	Must Operate Voltage *	Must Release Voltage *	Nominal operate power (mW)
3	90	2.25	2.25	100
4.5	203	3.38	3.38	100
5	250	3.75	3.75	100
6	360	4.5	4.5	100
9	810	6.75	6.75	100
12	960	9	9	150
24	3388	18	18	170

* Test by pulse voltage

TYPICAL PERFORMANCE DATA

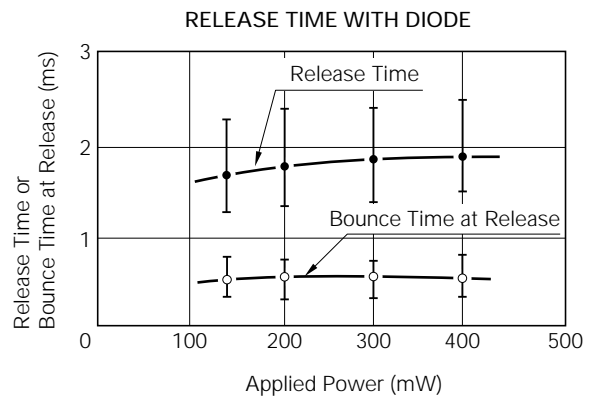
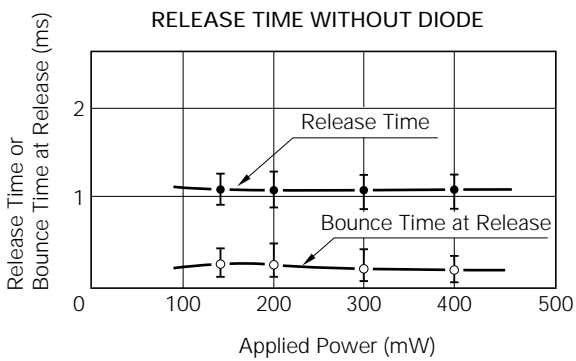
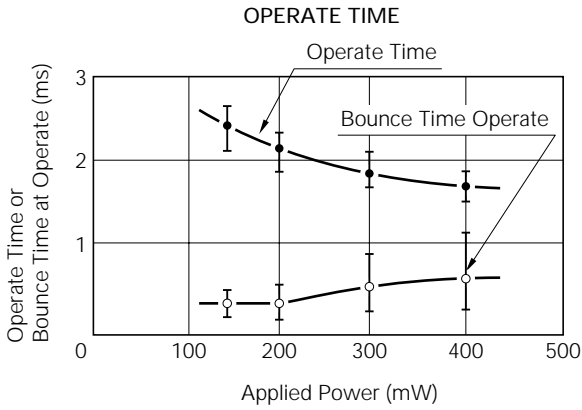
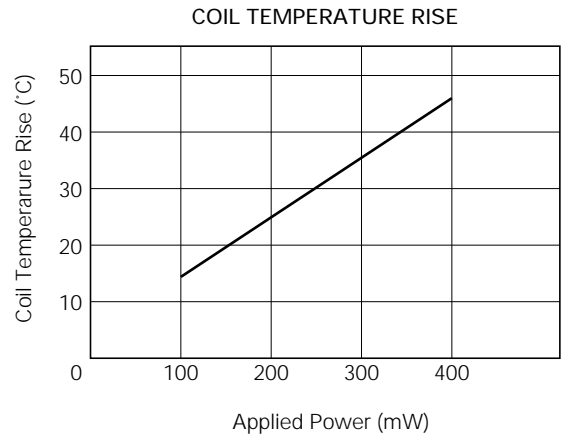
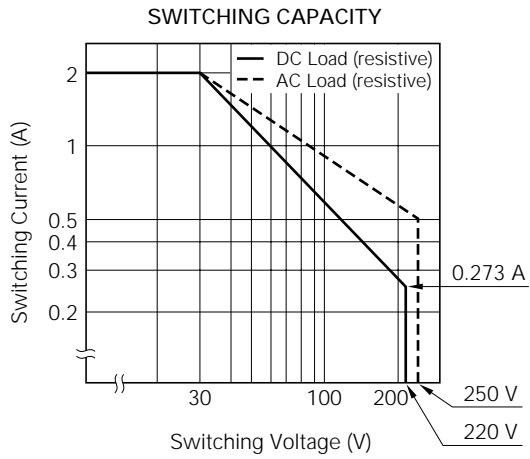

RUNNING SPECIFICATIONS (No load)

Sample : EC2-5ND n = 10

Temperature : 25 °C
Drive : 5 Vdc, 50 Hz 50 % duty

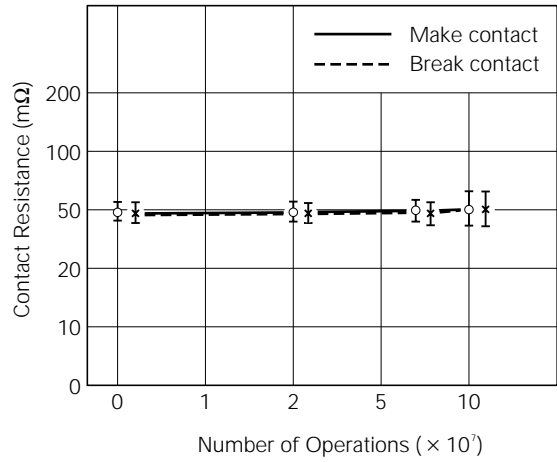
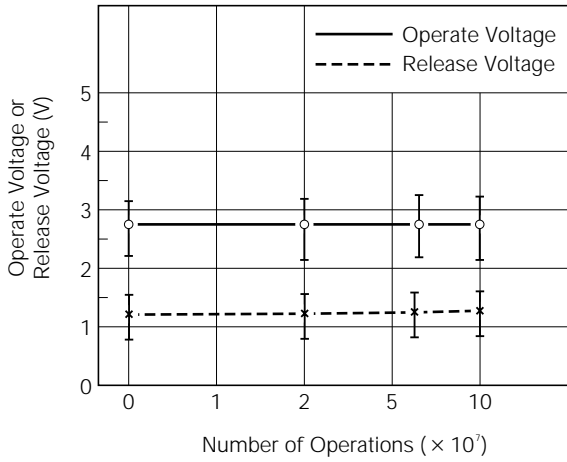

RUNNING SPECIFICATIONS (Load)

Sample : EC2-5ND n = 10
Load : 50 Vdc, 0.1 A Resistive

Temperature : 25 °C
Drive : 5 Vdc, 2 Hz 50 % duty

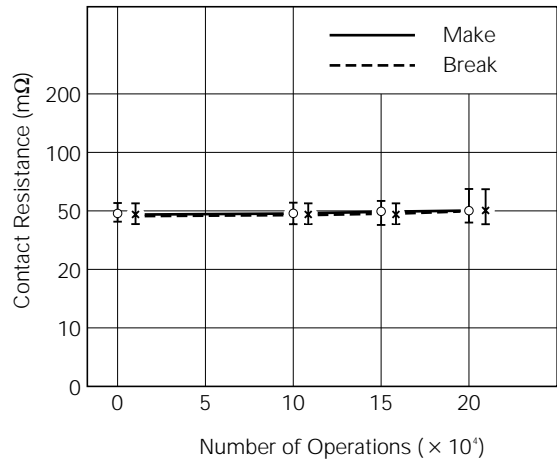
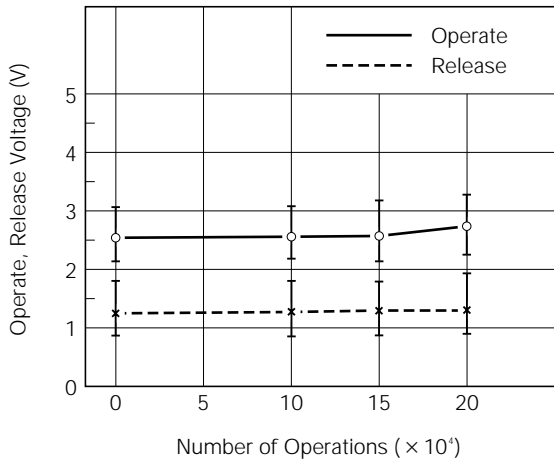

BREAKDOWN VOLTAGE

Sample : EC2-5ND

(a) Between Open Contacts (n = 10 pcs)

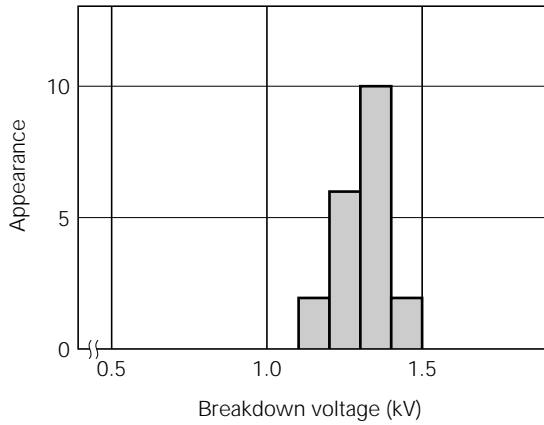

(a) Between Adjacent Contacts (n = 10 pcs)

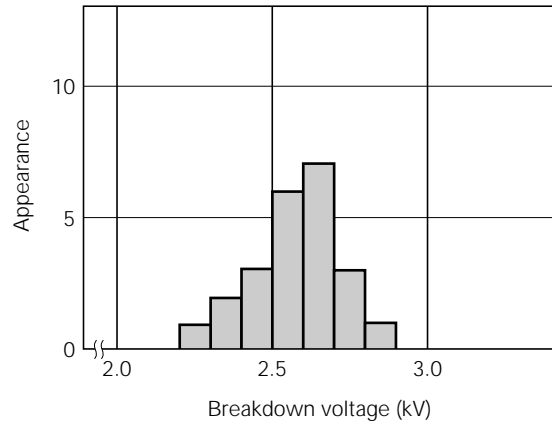

(a) Between Coil and Contacts (n = 25 pcs)

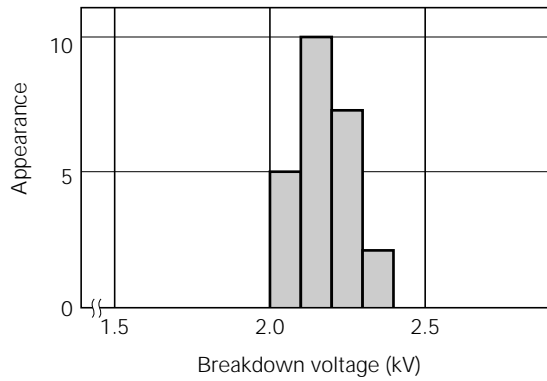

MAGNETIC INTERFERENCE

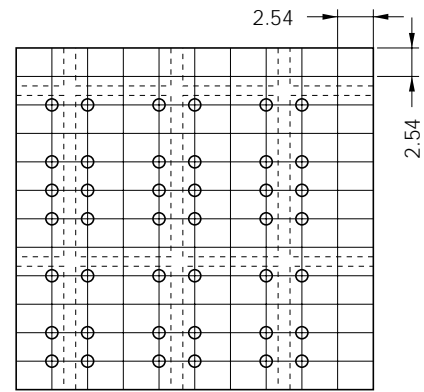
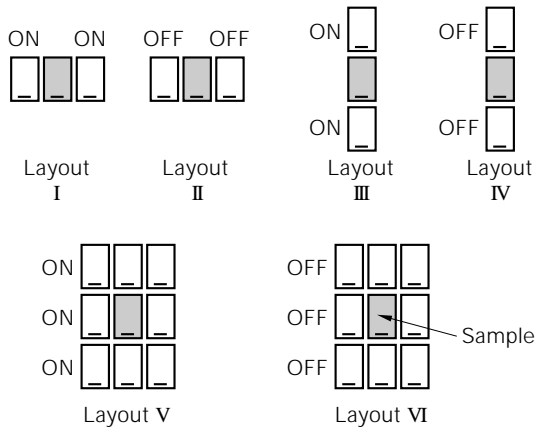
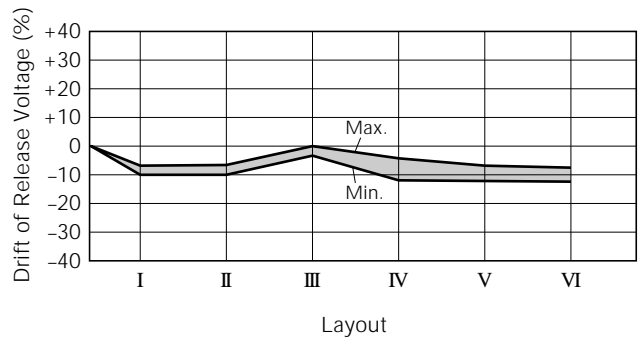
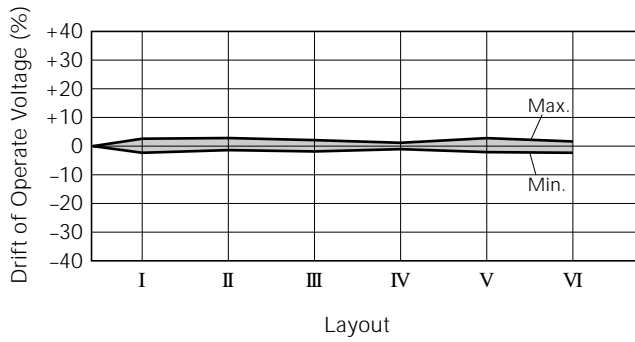

Mounting Layout (mm)

TUBE PACKAGE <EC2 (ND), EE2 (ND)>

Dimension of Package (Unit : mm)

35 pieces / Tube
Material : Polyvinyl chloride
(anti-static treated)

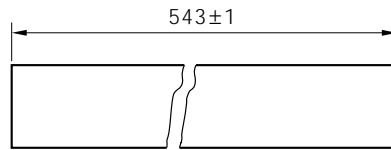
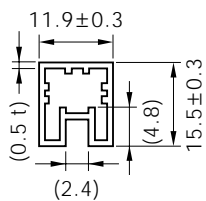

() Reference

Outline of Package

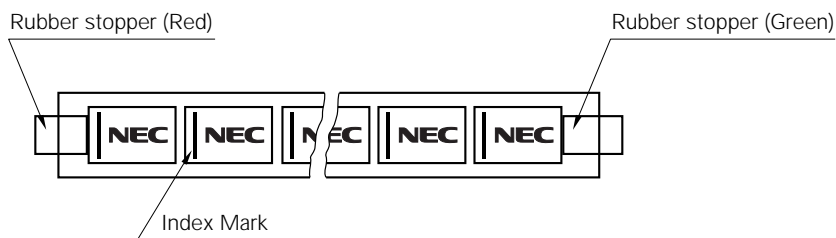

TAPE PACKAGE <EE2 (ND)>

APPEARANCE

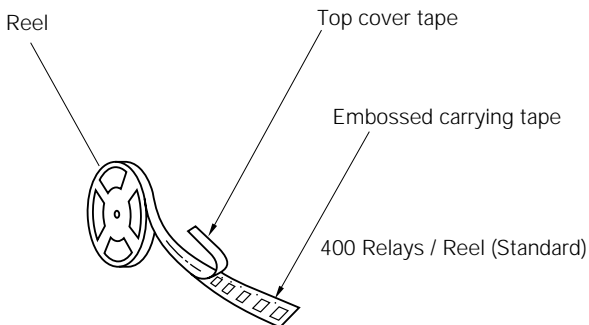

TAPE DIMENSIONS Unit : mm (inch)

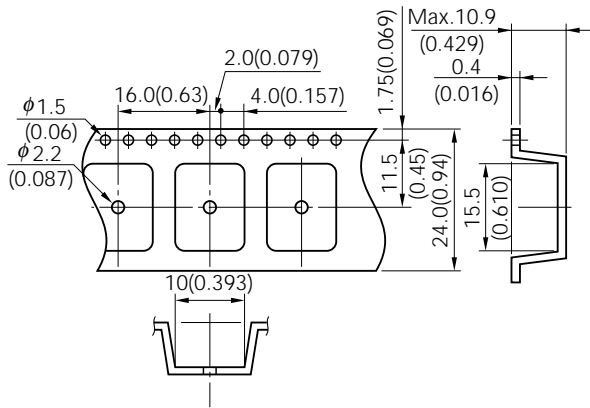

Relay orientation mark and tape carrying direction.

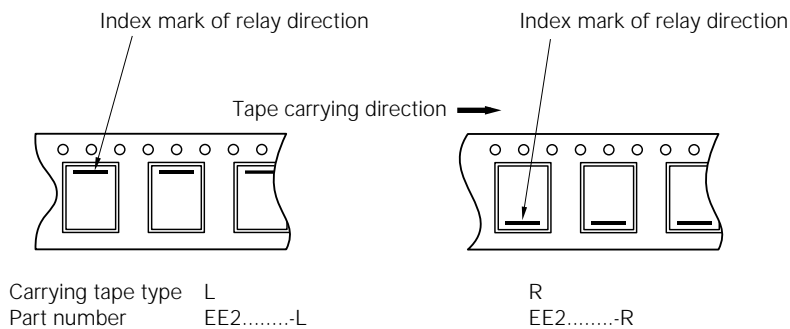

SOLDERING TEMPERATURE CONDITION

Through-hole mounting type <EC2 (ND)>

- ① Automatic soldering
 - * Preheating : 100°C max. 1 minute max.
 - * Solder temperature : 250°C max.
 - * Solder time : 10 seconds max.
- ② Manual soldering
 - * Solder temperature : 350°C max.
 - * Solder time : 3 seconds max.

Surface mounting type <EE2 (ND)>

IRS Method

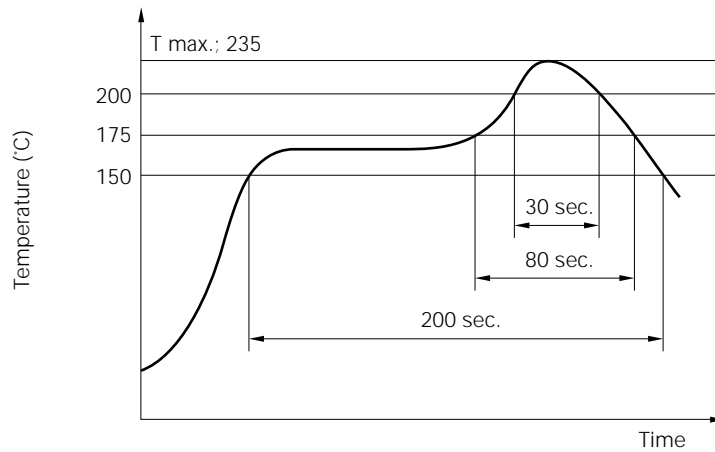

VPS Method

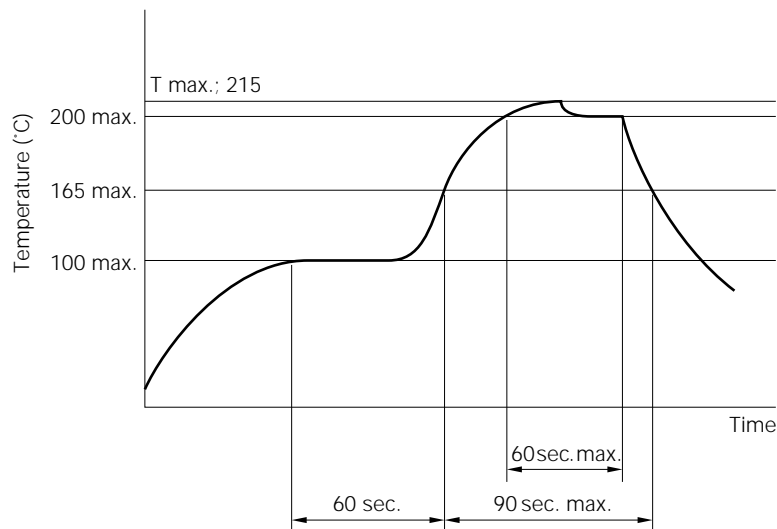

Note:

1. Temperature profile shows printed circuit board surface temperature on the relay terminal portion.
2. Check the actual soldering condition to use other method except above mentioned temperature profiles.

GUIDE TO APPLICATIONS

1. When connecting coils, refer to the pin configuration to prevent misoperation or malfunction.
2. The latch type relay should be initialized at the appointed position (set or reset position) when using, and should be energized or deenergized to the specified polarity to avoid wrong operations by reversed contact state.
3. Ultrasonic cleaning is not recommended to keep contact performance reliable. Alcohol based solvents are available as proper solvents.
4. Pressurized stress on the relay cover may affect reliable operation.
5. Minimum contact load of the relay is 100 mV, 100 μ A. This value is a reference value in the resistance load. Minimum capacity changes depending on switching frequency and environment temperature and the load.

No part of this document may be copied or reproduced in any form or by any means without the prior written consent of NEC Corporation. NEC Corporation assumes no responsibility for any errors which may appear in this document.

NEC Corporation does not assume any liability for infringement of patents, copyrights or other intellectual property rights of third parties by or arising from use of a device described herein or any other liability arising from use of such device. No license, either express, implied or otherwise, is granted under any patents, copyrights or other intellectual property rights of NEC Corporation or others.

While NEC Corporation has been making continuous effort to enhance the reliability of its Electronic Components, the possibility of defects cannot be eliminated entirely. To minimize risks of damage or injury to persons or property arising from a defect in an NEC Electronic Component, customers must incorporate sufficient safety measures in its design, such as redundancy, fire-containment, and anti-failure features.

NEC devices are classified into the following three quality grades:

"Standard", "Special", and "Specific". The Specific quality grade applies only to devices developed based on a customer designated "quality assurance program" for a specific application. The recommended applications of a device depend on its quality grade, as indicated below. Customers must check the quality grade of each device before using it in a particular application.

Standard: Computers, office equipment, communications equipment, test and measurement equipment, audio and visual equipment, home electronic appliances, machine tools, personal electronic equipment and industrial robots

Special: Transportation equipment (automobiles, trains, ships, etc.), traffic control systems, anti-disaster systems, anti-crime systems, safety equipment and medical equipment (not specifically designed for life support)

Specific: Aircrafts, aerospace equipment, submersible repeaters, nuclear reactor control systems, life support systems or medical equipment for life support, etc.

The quality grade of NEC devices is "Standard" unless otherwise specified in NEC's Data Sheets or Data Books.

If customers intend to use NEC devices for applications other than those specified for Standard quality grade, they should contact an NEC sales representative in advance.

Anti-radioactive design is not implemented in this product.