

## Programmable Shunt Regulator

## BL431RH

### FEATURES

- Programmable output voltage to 36 volts
- Low dynamic output impedance 0.20 typical
- Sink current capability of 1.0 to 100mA
- Equivalent full-range temperature coefficient of 50ppm/°C typical
- Temperature compensated for operation over full rated  
Operating temperature range -40~+125°C
- Low output noise voltage
- Fast turn-on response

HF

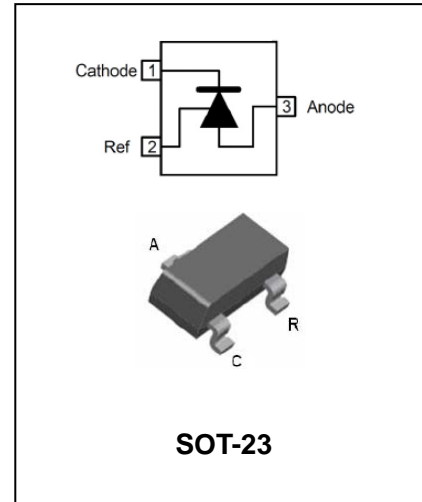

### ORDERING INFORMATION

| Type No. | Marking | Package Code |
|----------|---------|--------------|
| BL431RH  | 431RH   | SOT-23       |

### MAXIMUM RATING @ Ta=25°C unless otherwise specified

| Parameter  | Symbol             | limits       | unit |
|--|--------------------|--------------|------|
| Electrostatic discharge<br>(HBM), per ANSI/ESDA/JEDEC JS-001 (Note1)         | V <sub>(ESD)</sub> | ±2000        | V    |
| Electrostatic discharge<br>(CDM), per JEDEC specification JESD22C101 (Note2) |                    | ±1000        |      |
| Cathode Voltage  | V <sub>KA</sub>    | 36           | V    |
| Cathode current Range(Continuous)  | I <sub>KA</sub>    | -100 to +150 | mA   |
| Reference Input Current Range  | I <sub>REF</sub>   | 0.05 to 10   | mA   |
| Power dissipation  | P <sub>D</sub>     | 350          | mW   |
| Thermal Resistance Junction-to-Ambient                                       | R <sub>θJA</sub>   | 350          | °C/W |
| Thermal Resistance, Junction-to-Case   | R <sub>θJC</sub>   | 155          | °C/W |
| Operating Junction Temperature   | T <sub>J</sub>     | 150          | °C   |
| Operating temperature Range  | T <sub>OPR</sub>   | -40 to +125  | °C   |
| Storage temperature Range  | T <sub>STG</sub>   | -65 to +150  | °C   |

Notes:

1. JEDEC document JEP155 states that 500-v HBM allows safe manufacturing with a standard ESD control process. Manufacturing with less than 500-v HBM is possible with the necessary precautions.
2. JEDEC document JEP157 states that 250-v CDM allows safe manufacturing with a standard ESD control process. Manufacturing with less than 250-v CDM is possible with the necessary precautions.

## Programmable Shunt Regulator

## BL431RH

### Recommended Operating Conditions

| Parameter       | symbol   | Min       | Typ | Max | Unit |
|-----------------|----------|-----------|-----|-----|------|
| Cathode Voltage | $V_{KA}$ | $V_{REF}$ | -   | 36  | V    |
| Cathode Current | $I_{KA}$ | 1.0       | -   | 100 | mA   |

### ELECTRICAL CHARACTERISTICS @ $T_a=25^\circ\text{C}$ unless otherwise specified

| Parameter   | symbol                         | conditions  | Min. | Typ. | Max. | unit          |
|---|--------------------------------|---|------|------|------|---------------|
| Reference Input voltage   | $V_{REF}$                      | $V_{KA}=V_{REF}, I_{KA}=10\text{mA}$  | 2.44 | 2.5  | 2.55 | V             |
| Deviation of Reference Input Voltage Over-Temperature                       | $\Delta V_{REF}/\Delta T$      | $V_{KA}=V_{REF}, I_{KA}=10\text{mA}, T_{MIN}\leq T_A\leq T_{MAX}$             |      | 4.5  | 17   | mV            |
| Ratio of Change in Reference Input Voltage to the Change in Cathode Voltage | $\Delta V_{REF}/\Delta V_{KA}$ | $I_{KA}=10\text{mA}$<br>$\Delta V_{KA}=10\text{V}-V_{REF}$                    |      | -10  | -2.7 | mV/V          |
|   |                                | $\Delta V_{KA}=36\text{V}-10\text{V}$   |      | -0.5 | -2.0 |               |
| Reverse Input current   | $I_{REF}$                      | $I_{KA}=10\text{mA}, R_1=10\text{K}\Omega, R_2=\infty$                        |      | 1.5  | 4    | $\mu\text{A}$ |
| Deviation of Reference Input Current Over Full Temperature Range            | $\Delta I_{REF}/\Delta T$      | $I_{KA}=10\text{mA}, R_1=10\text{K}\Omega, R_2=\infty, T_A=\text{Full Range}$ |      | 0.4  | 1.2  | $\mu\text{A}$ |
| Minimum Cathode Current for Regulation                                      | $I_{KA(MIN)}$                  | $V_{KA}=V_{REF}$  |      | 0.45 | 1.0  | mA            |
| Off-Stage Cathode Current   | $I_{KA(OFF)}$                  | $V_{KA}=36\text{V}, V_{REF}=0$  |      | 0.05 | 1.0  | $\mu\text{A}$ |
| Dynamic Impedance   | $Z_{ZA}$                       | $V_{KA}=V_{REF}, I_{KA}=1\text{ to }100\text{mA}, f\geq 1.0\text{KHz}$        |      | 0.15 | 0.5  | $\Omega$      |

• $T_{MIN}=-40^\circ\text{C}, T_{MAX}=+125^\circ\text{C}$

### CLASSIFICATION OF $V_{ref}$

| Rank  | 0.5%        | 1%          | 2%          |
|-------|-------------|-------------|-------------|
| Range | 2.488-2.512 | 2.475-2.525 | 2.450-2.550 |

**Programmable Shunt Regulator**

**BL431RH**

TYPICAL CHARACTERISTICS @  $T_a=25^\circ\text{C}$  unless otherwise specified

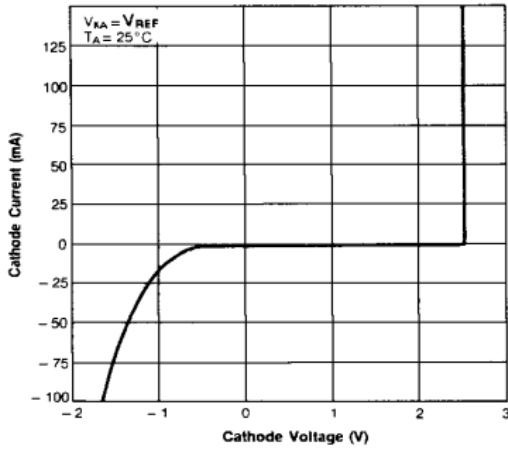

Figure 1. Cathode Current vs. Cathode Voltage

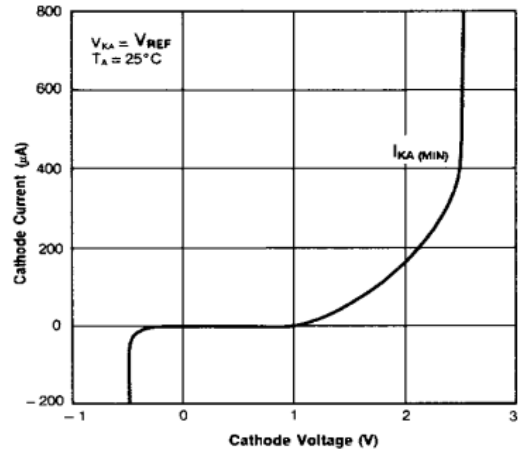

Figure 2. Cathode Current vs. Cathode Voltage

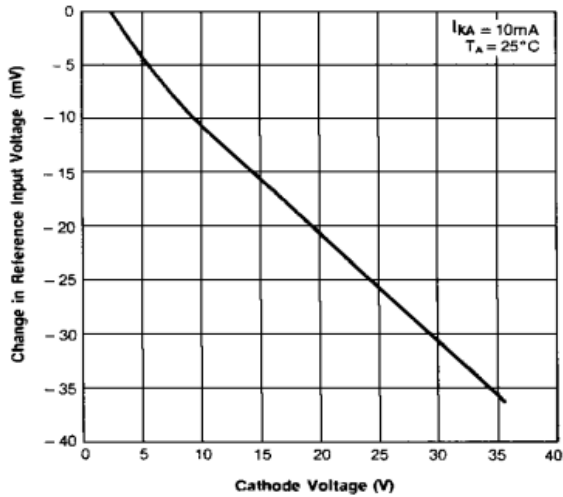

Figure 3. Change In Reference Input Voltage vs. Cathode Voltage

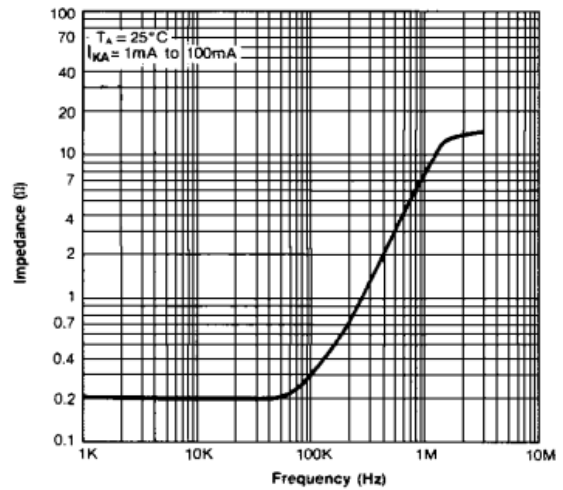

Figure 4. Dynamic Impedance Frequency

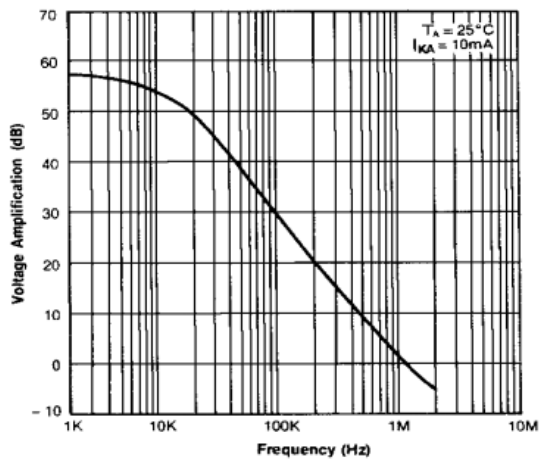

Figure 5. Small Signal Voltage Amplification vs. Frequency

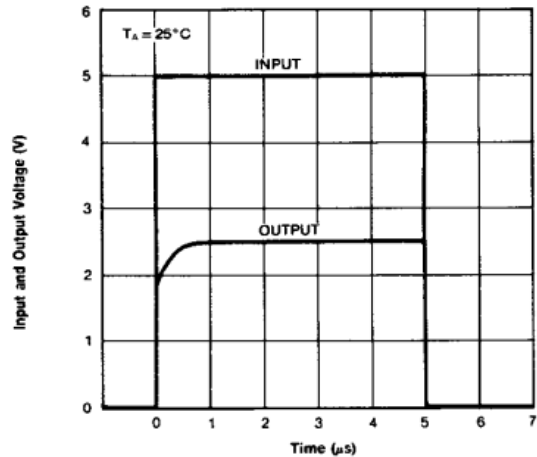

Figure 6. Pulse Response

Programmable Shunt Regulator

BL431RH

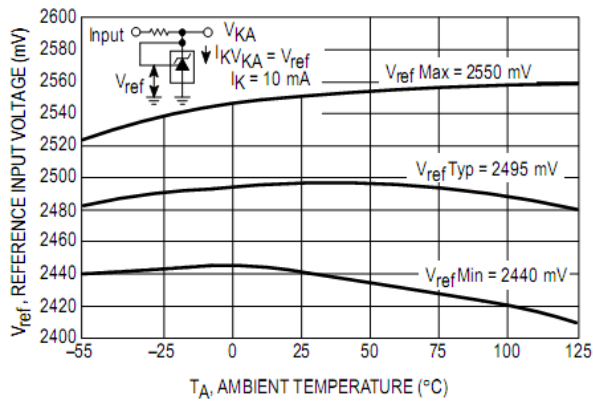

Figure 7. Reference Input Voltage versus Ambient Temperature

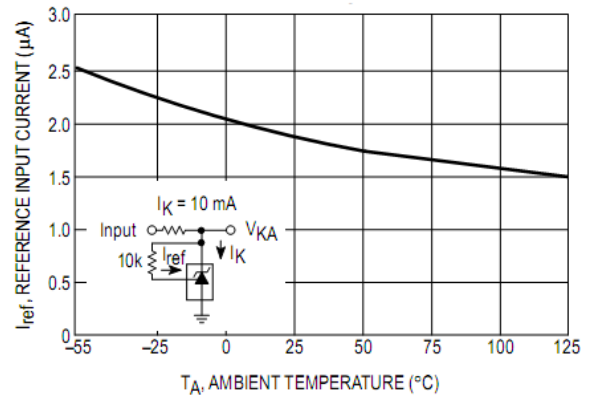

Figure 8. Reference Input Current versus Ambient Temperature

## Programmable Shunt Regulator

## BL431RH

### PACKAGE OUTLINE

Plastic surface mounted package

SOT-23

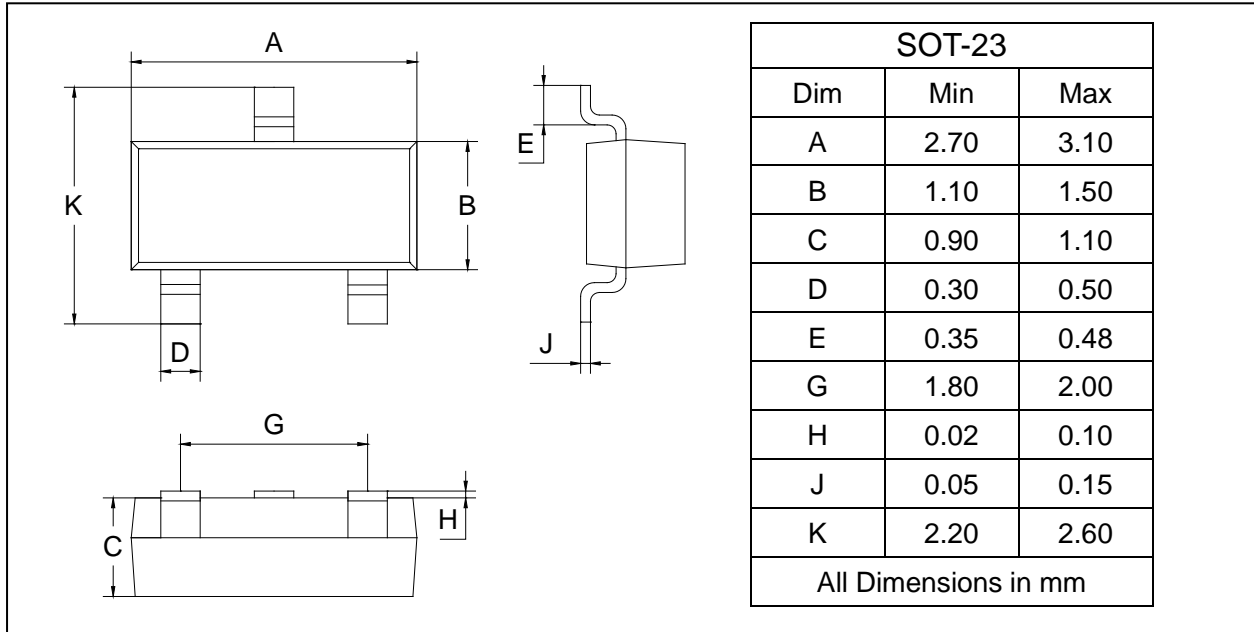

### SOLDERING FOOTPRINT

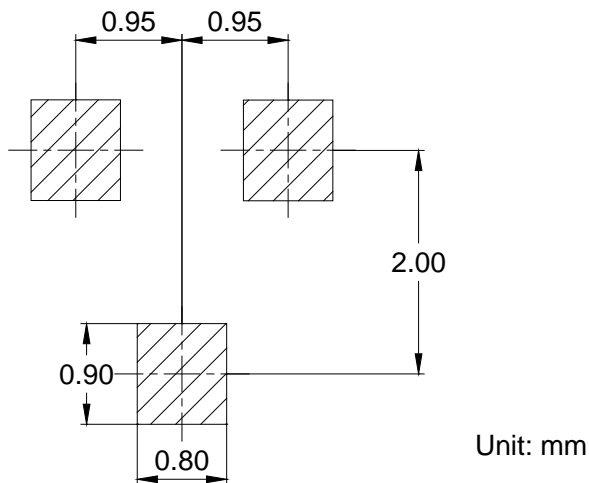

### PACKAGE INFORMATION

| Device  | Package | Shipping       |
|---------|---------|----------------|
| BL431RH | SOT-23  | 3000/Tape&Reel |