

To our customers,

---

## Old Company Name in Catalogs and Other Documents

---

On April 1<sup>st</sup>, 2010, NEC Electronics Corporation merged with Renesas Technology Corporation, and Renesas Electronics Corporation took over all the business of both companies. Therefore, although the old company name remains in this document, it is a valid Renesas Electronics document. We appreciate your understanding.

Renesas Electronics website: <http://www.renesas.com>

April 1<sup>st</sup>, 2010  
Renesas Electronics Corporation

Issued by: Renesas Electronics Corporation (<http://www.renesas.com>)

Send any inquiries to <http://www.renesas.com/inquiry>.

## Notice

1. All information included in this document is current as of the date this document is issued. Such information, however, is subject to change without any prior notice. Before purchasing or using any Renesas Electronics products listed herein, please confirm the latest product information with a Renesas Electronics sales office. Also, please pay regular and careful attention to additional and different information to be disclosed by Renesas Electronics such as that disclosed through our website.
2. Renesas Electronics does not assume any liability for infringement of patents, copyrights, or other intellectual property rights of third parties by or arising from the use of Renesas Electronics products or technical information described in this document. No license, express, implied or otherwise, is granted hereby under any patents, copyrights or other intellectual property rights of Renesas Electronics or others.
3. You should not alter, modify, copy, or otherwise misappropriate any Renesas Electronics product, whether in whole or in part.
4. Descriptions of circuits, software and other related information in this document are provided only to illustrate the operation of semiconductor products and application examples. You are fully responsible for the incorporation of these circuits, software, and information in the design of your equipment. Renesas Electronics assumes no responsibility for any losses incurred by you or third parties arising from the use of these circuits, software, or information.
5. When exporting the products or technology described in this document, you should comply with the applicable export control laws and regulations and follow the procedures required by such laws and regulations. You should not use Renesas Electronics products or the technology described in this document for any purpose relating to military applications or use by the military, including but not limited to the development of weapons of mass destruction. Renesas Electronics products and technology may not be used for or incorporated into any products or systems whose manufacture, use, or sale is prohibited under any applicable domestic or foreign laws or regulations.
6. Renesas Electronics has used reasonable care in preparing the information included in this document, but Renesas Electronics does not warrant that such information is error free. Renesas Electronics assumes no liability whatsoever for any damages incurred by you resulting from errors in or omissions from the information included herein.
7. Renesas Electronics products are classified according to the following three quality grades: “Standard”, “High Quality”, and “Specific”. The recommended applications for each Renesas Electronics product depends on the product’s quality grade, as indicated below. You must check the quality grade of each Renesas Electronics product before using it in a particular application. You may not use any Renesas Electronics product for any application categorized as “Specific” without the prior written consent of Renesas Electronics. Further, you may not use any Renesas Electronics product for any application for which it is not intended without the prior written consent of Renesas Electronics. Renesas Electronics shall not be in any way liable for any damages or losses incurred by you or third parties arising from the use of any Renesas Electronics product for an application categorized as “Specific” or for which the product is not intended where you have failed to obtain the prior written consent of Renesas Electronics. The quality grade of each Renesas Electronics product is “Standard” unless otherwise expressly specified in a Renesas Electronics data sheets or data books, etc.
  - “Standard”: Computers; office equipment; communications equipment; test and measurement equipment; audio and visual equipment; home electronic appliances; machine tools; personal electronic equipment; and industrial robots.
  - “High Quality”: Transportation equipment (automobiles, trains, ships, etc.); traffic control systems; anti-disaster systems; anti-crime systems; safety equipment; and medical equipment not specifically designed for life support.
  - “Specific”: Aircraft; aerospace equipment; submersible repeaters; nuclear reactor control systems; medical equipment or systems for life support (e.g. artificial life support devices or systems), surgical implantations, or healthcare intervention (e.g. excision, etc.), and any other applications or purposes that pose a direct threat to human life.
8. You should use the Renesas Electronics products described in this document within the range specified by Renesas Electronics, especially with respect to the maximum rating, operating supply voltage range, movement power voltage range, heat radiation characteristics, installation and other product characteristics. Renesas Electronics shall have no liability for malfunctions or damages arising out of the use of Renesas Electronics products beyond such specified ranges.
9. Although Renesas Electronics endeavors to improve the quality and reliability of its products, semiconductor products have specific characteristics such as the occurrence of failure at a certain rate and malfunctions under certain use conditions. Further, Renesas Electronics products are not subject to radiation resistance design. Please be sure to implement safety measures to guard them against the possibility of physical injury, and injury or damage caused by fire in the event of the failure of a Renesas Electronics product, such as safety design for hardware and software including but not limited to redundancy, fire control and malfunction prevention, appropriate treatment for aging degradation or any other appropriate measures. Because the evaluation of microcomputer software alone is very difficult, please evaluate the safety of the final products or system manufactured by you.
10. Please contact a Renesas Electronics sales office for details as to environmental matters such as the environmental compatibility of each Renesas Electronics product. Please use Renesas Electronics products in compliance with all applicable laws and regulations that regulate the inclusion or use of controlled substances, including without limitation, the EU RoHS Directive. Renesas Electronics assumes no liability for damages or losses occurring as a result of your noncompliance with applicable laws and regulations.
11. This document may not be reproduced or duplicated, in any form, in whole or in part, without prior written consent of Renesas Electronics.
12. Please contact a Renesas Electronics sales office if you have any questions regarding the information contained in this document or Renesas Electronics products, or if you have any other inquiries.

(Note 1) “Renesas Electronics” as used in this document means Renesas Electronics Corporation and also includes its majority-owned subsidiaries.

(Note 2) “Renesas Electronics product(s)” means any product developed or manufactured by or for Renesas Electronics.

## NPN EPITAXIAL SILICON TRANSISTOR 4-PIN MINI MOLD

### FEATURE

- Ideal for medium-output applications
- High gain, low noise
- Small reverse transfer capacitance
- Can operate at low voltage

### ABSOLUTE MAXIMUM RATINGS (T<sub>A</sub> = 25 °C)

PARAMETER	SYMBOL	RATING	UNIT
Collector to Base Voltage	V <sub>CB0</sub>	9	V
Collector to Emitter Voltage	V <sub>CEO</sub>	6	V
Emitter to Base Voltage	V <sub>EBO</sub>	2	V
Collector Current	I <sub>c</sub>	100	mA
Total Power Dissipation	P <sub>T</sub>	200	mW
Junction Temperature	T <sub>j</sub>	150	°C
Storage Temperature	T <sub>stg</sub>	-65 to +150	°C

### PACKAGE DIMENSIONS (in mm)

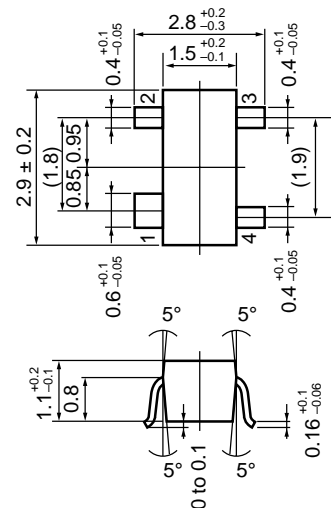

### PIN CONNECTIONS

- 1: Collector
- 2: Emitter
- 3: Base
- 4: Emitter

### ELECTRICAL CHARACTERISTICS (T<sub>A</sub> = 25 °C)

PARAMETER	SYMBOL	TEST CONDITIONS	MIN.	TYP.	MAX.	UNIT
Collector Cut-off Current	I <sub>CBO</sub>	V <sub>CB</sub> = 5 V, I <sub>E</sub> = 0			0.1	μA
Emitter Cut-off Current	I <sub>EBO</sub>	V <sub>EB</sub> = 1 V, I <sub>C</sub> = 0			0.1	μA
DC Current Gain	h <sub>FE</sub>	V <sub>CE</sub> = 3 V, I <sub>C</sub> = 30 mA <sup>Note 1</sup>	75		150	
Gain Bandwidth Product	f <sub>T</sub>	V <sub>CE</sub> = 3 V, I <sub>C</sub> = 30 mA, f = 2 GHz		12.0		GHz
Reverse Transfer Capacitance	C <sub>re</sub>	V <sub>CB</sub> = 3 V, I <sub>E</sub> = 0, f = 1 MHz <sup>Note 2</sup>		0.5	0.7	pF
Insertion Power Gain	S <sub>21e</sub>   <sup>2</sup>	V <sub>CE</sub> = 3 V, I <sub>C</sub> = 30 mA, f = 2 GHz	8.0	10.0		dB
Noise Figure	NF	V <sub>CE</sub> = 3 V, I <sub>C</sub> = 7 mA, f = 2 GHz		1.5	2.5	dB

**Notes** 1. Pulse measurement P<sub>w</sub> ≤ 350 μs, duty cycle ≤ 2 %

2. Collector to base capacitance measured by capacitance meter (automatic balance bridge method) when emitter pin is connected to the guard pin.

**Because this product uses high-frequency process, avoid excessive input of static electricity, etc.**

The information in this document is subject to change without notice.

**h<sub>FE</sub> CLASSIFICATION**

RANK	FB
Marking	R55
h <sub>FE</sub>	75 to 150

**TYPICAL CHARACTERISTICS (T<sub>A</sub> = 25 °C)**

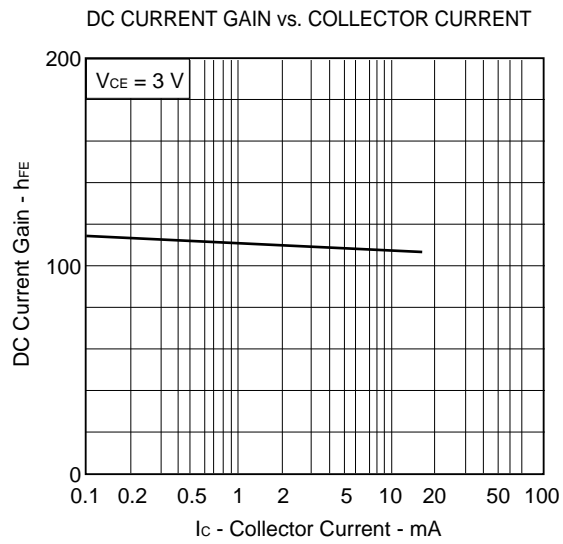
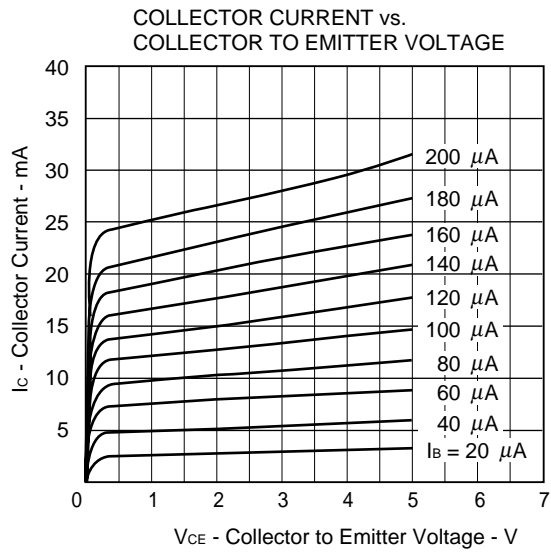
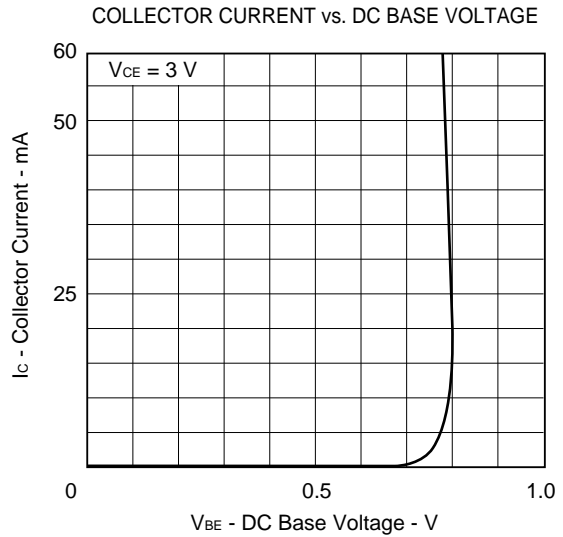
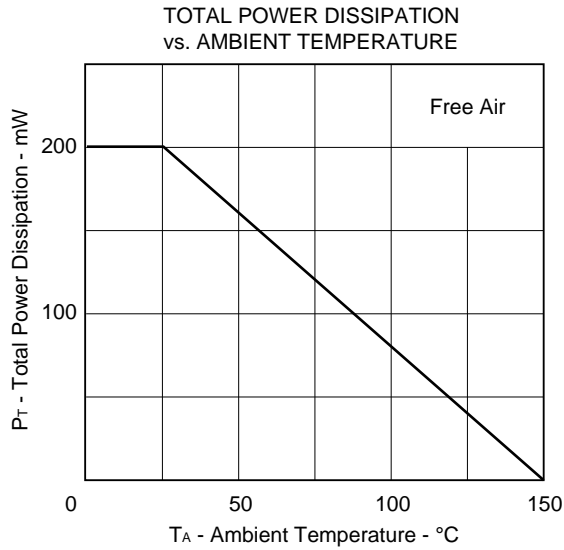

GAIN BANDWIDTH PRODUCT  
vs. COLLECTOR CURRENT

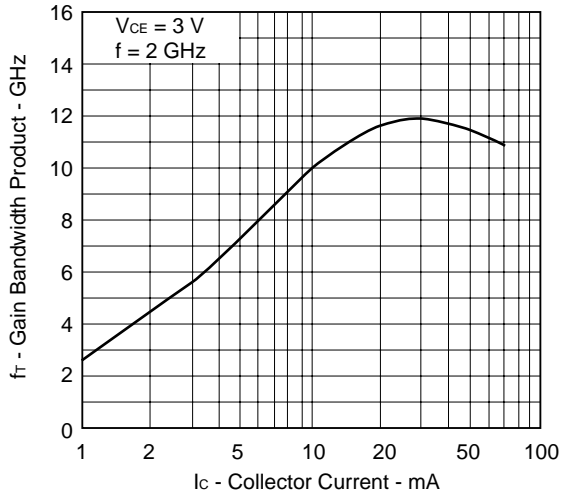

INSERTION POWER GAIN  
vs. COLLECTOR CURRENT

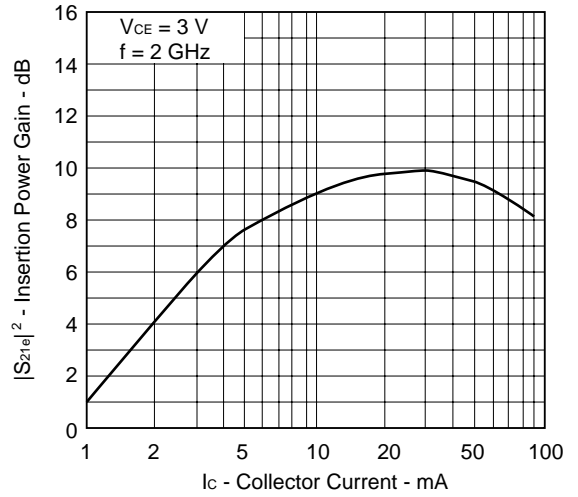

GAIN WITH MINIMUM NF/NOISE FIGURE  
vs. COLLECTOR CURRENT

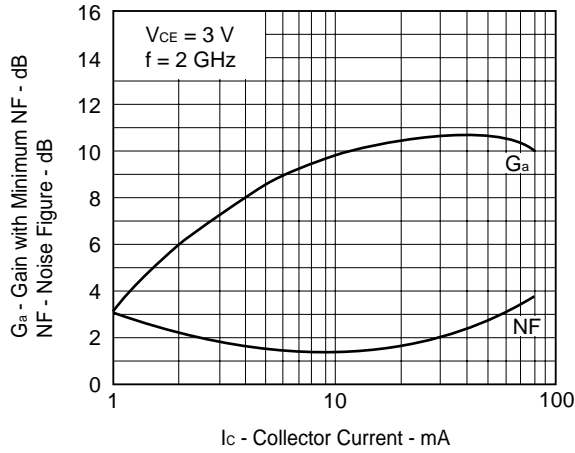

REVERSE TRANSFER CAPACITANCE  
vs. COLLECTOR TO BASE VOLTAGE

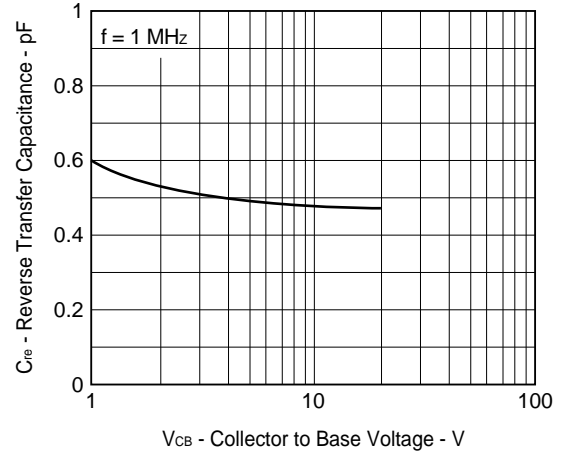

MAXIMUM AVAILABLE GAIN/  
MAXIMUM STABLE GAIN/INSERTION  
POWER GAIN vs. FREQUENCY

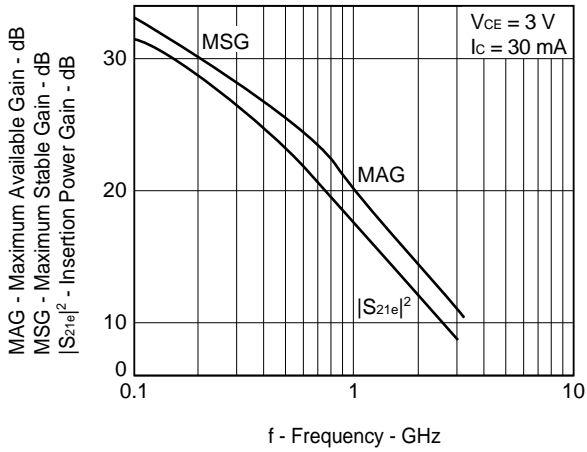

OUTPUT POWER vs. INPUT POWER

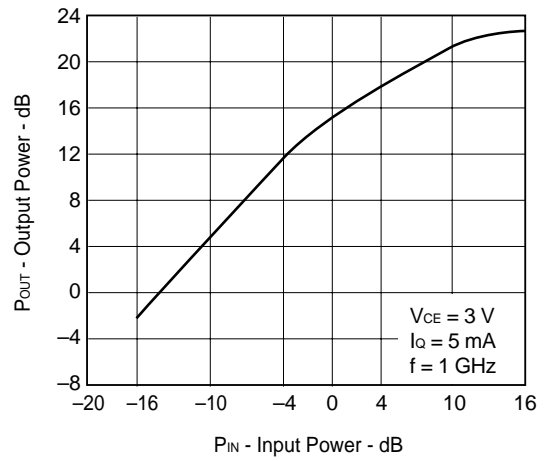

OUTPUT POWER vs. INPUT POWER

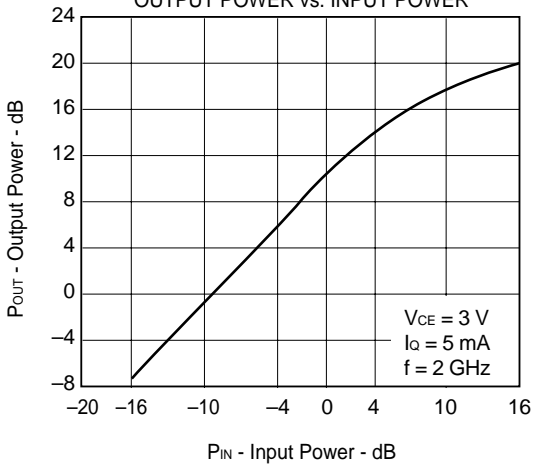

2SC5455 S PARAMETER

V<sub>CE</sub> = 3.0 V, I<sub>c</sub> = 5.0 mA, Z<sub>0</sub> = 50 Ω

FREQUENCY		S <sub>11</sub>		S <sub>21</sub>		S <sub>12</sub>		S <sub>22</sub>	
MHz	MAG	ANG	MAG	ANG	MAG	ANG	MAG	ANG	
100.00	0.849	-29.2	14.200	159.5	0.026	74.3	0.948	-16.9	
200.00	0.792	-55.4	12.643	142.7	0.046	60.0	0.849	-32.0	
300.00	0.732	-78.7	11.179	128.9	0.060	49.1	0.742	-43.3	
400.00	0.688	-97.0	9.470	118.4	0.069	41.5	0.644	-52.7	
500.00	0.640	-113.2	8.319	107.7	0.074	36.6	0.569	-58.6	
600.00	0.613	-127.0	7.339	100.0	0.078	32.3	0.511	-64.0	
700.00	0.594	-137.9	6.450	93.3	0.080	30.4	0.462	-69.0	
800.00	0.581	-147.8	5.764	87.3	0.082	28.7	0.427	-73.1	
900.00	0.574	-156.2	5.176	82.2	0.083	26.9	0.395	-77.0	
1000.00	0.570	-163.6	4.717	77.3	0.084	26.3	0.374	-80.9	
1100.00	0.569	-170.1	4.318	72.9	0.085	25.4	0.358	-84.8	
1200.00	0.570	-176.2	3.974	68.7	0.086	25.9	0.343	-88.1	
1300.00	0.574	178.4	3.673	64.7	0.086	26.2	0.334	-92.4	
1400.00	0.577	173.4	3.429	60.7	0.087	26.3	0.326	-96.2	
1500.00	0.583	168.7	3.202	57.1	0.089	26.8	0.322	-100.4	
1600.00	0.589	164.5	2.984	53.5	0.090	27.3	0.321	-103.9	
1700.00	0.596	160.5	2.831	49.9	0.091	28.1	0.316	-108.7	
1800.00	0.603	156.8	2.669	46.5	0.093	29.2	0.319	-111.9	
1900.00	0.610	153.0	2.523	42.7	0.095	29.7	0.319	-117.2	
2000.00	0.617	149.9	2.396	39.6	0.097	30.6	0.323	-119.9	
2100.00	0.624	146.4	2.268	36.1	0.099	31.2	0.328	-125.4	
2200.00	0.632	143.5	2.162	32.9	0.102	31.6	0.333	-127.0	
2300.00	0.637	140.5	2.044	29.9	0.104	32.7	0.341	-133.3	
2400.00	0.645	137.6	1.952	26.7	0.108	33.4	0.346	-133.8	
2500.00	0.646	135.1	1.870	24.4	0.111	34.1	0.357	-139.6	
2600.00	0.654	132.4	1.773	21.2	0.115	34.6	0.369	-140.4	
2700.00	0.660	130.3	1.712	18.2	0.120	35.2	0.384	-145.9	
2800.00	0.666	127.7	1.632	15.9	0.124	34.7	0.393	-148.1	
2900.00	0.673	125.7	1.561	12.6	0.129	34.5	0.412	-152.4	
3000.00	0.676	123.3	1.494	10.7	0.133	34.3	0.418	-155.2	

V<sub>CE</sub> = 3.0 V, I<sub>c</sub> = 10.0 mA, Z<sub>0</sub> = 50 Ω

FREQUENCY		S <sub>11</sub>		S <sub>21</sub>		S <sub>12</sub>		S <sub>22</sub>	
MHz	MAG	ANG	MAG	ANG	MAG	ANG	MAG	ANG	
100.00	0.741	-41.6	23.253	153.2	0.023	69.0	0.898	-25.2	
200.00	0.668	-75.4	19.107	132.8	0.039	55.1	0.737	-44.8	
300.00	0.612	-101.6	15.604	118.6	0.048	46.1	0.597	-58.1	
400.00	0.576	-120.4	12.659	108.8	0.053	41.7	0.496	-68.0	
500.00	0.553	-135.2	10.612	99.9	0.057	39.5	0.423	-74.5	
600.00	0.541	-147.0	9.108	93.3	0.060	38.6	0.375	-80.4	
700.00	0.535	-156.6	7.906	87.8	0.063	38.2	0.332	-86.3	
800.00	0.532	-164.6	6.994	82.9	0.066	38.1	0.307	-90.7	
900.00	0.531	-171.5	6.238	78.4	0.069	38.4	0.285	-95.6	
1000.00	0.533	-177.6	5.639	74.3	0.072	38.8	0.269	-100.2	
1100.00	0.536	177.0	5.148	70.6	0.075	38.8	0.257	-105.1	
1200.00	0.540	171.9	4.726	66.9	0.079	39.4	0.249	-109.3	
1300.00	0.546	167.6	4.367	63.6	0.082	39.9	0.244	-114.2	
1400.00	0.551	163.4	4.060	59.9	0.085	40.0	0.241	-118.1	
1500.00	0.558	159.6	3.788	56.9	0.089	39.9	0.240	-123.1	
1600.00	0.565	156.0	3.543	53.5	0.092	39.9	0.243	-126.5	
1700.00	0.572	152.6	3.333	50.3	0.096	40.1	0.244	-131.6	
1800.00	0.579	149.5	3.146	47.4	0.100	40.1	0.248	-134.7	
1900.00	0.587	146.3	2.975	44.0	0.103	39.8	0.251	-140.5	
2000.00	0.592	143.8	2.819	41.1	0.107	40.0	0.255	-142.2	
2100.00	0.603	140.6	2.680	38.1	0.111	39.6	0.266	-148.0	
2200.00	0.611	138.1	2.548	35.1	0.115	39.1	0.268	-148.5	
2300.00	0.614	135.5	2.409	32.4	0.118	39.0	0.281	-154.5	
2400.00	0.624	133.0	2.300	29.6	0.122	38.7	0.283	-154.0	
2500.00	0.625	130.7	2.203	27.4	0.126	38.7	0.299	-159.2	
2600.00	0.635	128.3	2.097	24.8	0.131	38.1	0.306	-159.4	
2700.00	0.639	126.5	2.028	21.8	0.136	37.6	0.326	-164.0	
2800.00	0.647	124.1	1.934	19.7	0.140	36.8	0.332	-165.3	
2900.00	0.655	122.2	1.856	16.9	0.146	35.8	0.350	-168.9	
3000.00	0.658	120.0	1.783	15.0	0.149	35.3	0.356	-171.0	

2SC5455 S PARAMETER

V<sub>CE</sub> = 3.0 V, I<sub>c</sub> = 20.0 mA, Z<sub>0</sub> = 50 Ω

FREQUENCY MHz	S <sub>11</sub>		S <sub>21</sub>		S <sub>12</sub>		S <sub>22</sub>	
	MAG	ANG	MAG	ANG	MAG	ANG	MAG	ANG
100.00	0.608	-59.0	33.348	145.2	0.020	65.2	0.820	-35.6
200.00	0.556	-99.3	24.680	123.3	0.031	52.4	0.613	-58.4
300.00	0.527	-124.7	18.769	110.1	0.038	48.1	0.470	-73.0
400.00	0.505	-142.0	14.726	101.4	0.042	46.0	0.382	-83.6
500.00	0.510	-153.8	12.083	94.2	0.047	46.7	0.322	-91.6
600.00	0.508	-163.0	10.226	88.7	0.051	47.5	0.287	-98.7
700.00	0.509	-170.7	8.816	83.9	0.055	48.0	0.256	-105.3
800.00	0.512	-177.0	7.760	79.8	0.059	48.4	0.241	-111.0
900.00	0.516	-177.7	6.889	76.2	0.064	49.2	0.227	-116.8
1000.00	0.521	172.7	6.214	72.4	0.068	49.1	0.218	-121.8
1100.00	0.525	168.4	5.654	68.9	0.073	49.0	0.216	-127.6
1200.00	0.531	164.1	5.188	65.9	0.077	49.4	0.211	-131.7
1300.00	0.538	160.4	4.795	62.7	0.083	48.9	0.214	-136.8
1400.00	0.544	156.8	4.447	59.7	0.087	49.0	0.215	-140.8
1500.00	0.551	153.4	4.162	56.7	0.091	48.2	0.220	-146.1
1600.00	0.557	150.3	3.883	53.7	0.096	47.7	0.224	-148.7
1700.00	0.566	147.4	3.660	50.7	0.101	47.1	0.233	-153.2
1800.00	0.571	144.6	3.453	47.8	0.106	46.5	0.236	-156.3
1900.00	0.580	141.8	3.253	44.8	0.110	45.5	0.245	-161.2
2000.00	0.586	139.6	3.086	42.1	0.115	45.0	0.247	-162.1
2100.00	0.594	136.7	2.917	39.2	0.119	44.3	0.261	-166.9
2200.00	0.602	134.6	2.784	36.5	0.124	43.3	0.260	-167.6
2300.00	0.607	132.0	2.638	34.1	0.128	42.6	0.279	-172.6
2400.00	0.617	129.8	2.509	31.5	0.132	41.5	0.274	-172.3
2500.00	0.617	127.7	2.409	29.4	0.136	41.2	0.296	-175.9
2600.00	0.628	125.5	2.287	27.0	0.142	40.3	0.298	-175.6
2700.00	0.633	123.9	2.216	24.3	0.147	39.3	0.318	-179.5
2800.00	0.641	121.5	2.119	22.4	0.151	38.2	0.323	179.6
2900.00	0.647	119.9	2.033	19.8	0.156	36.9	0.341	177.1
3000.00	0.651	117.7	1.959	18.0	0.160	36.0	0.347	175.1

V<sub>CE</sub> = 3.0 V, I<sub>c</sub> = 30.0 mA, Z<sub>0</sub> = 50 Ω

FREQUENCY MHz	S <sub>11</sub>		S <sub>21</sub>		S <sub>12</sub>		S <sub>22</sub>	
	MAG	ANG	MAG	ANG	MAG	ANG	MAG	ANG
100.00	0.540	-70.7	38.305	140.7	0.019	63.3	0.773	-41.2
200.00	0.512	-112.4	26.801	118.8	0.028	51.9	0.547	-65.8
300.00	0.500	-136.0	19.773	106.5	0.033	49.4	0.415	-80.8
400.00	0.503	-150.9	15.344	98.5	0.037	51.0	0.337	-92.0
500.00	0.500	-161.7	12.506	91.8	0.043	51.3	0.285	-100.3
600.00	0.502	-169.8	10.529	86.8	0.048	52.1	0.256	-107.8
700.00	0.508	-176.6	9.061	82.3	0.053	52.6	0.234	-114.9
800.00	0.511	177.8	7.950	78.4	0.057	52.8	0.222	-120.7
900.00	0.516	172.6	7.064	74.9	0.062	53.0	0.213	-126.9
1000.00	0.521	168.2	6.367	71.5	0.068	53.6	0.208	-132.0
1100.00	0.526	164.3	5.804	68.3	0.073	53.1	0.207	-137.8
1200.00	0.533	160.3	5.306	65.2	0.078	53.2	0.207	-142.0
1300.00	0.539	156.9	4.899	62.2	0.083	52.2	0.211	-146.3
1400.00	0.545	153.5	4.553	59.2	0.088	51.8	0.213	-150.9
1500.00	0.553	150.6	4.263	56.4	0.093	51.2	0.221	-154.8
1600.00	0.559	147.5	3.967	53.5	0.098	50.8	0.226	-157.3
1700.00	0.567	144.8	3.744	50.4	0.104	49.5	0.233	-162.3
1800.00	0.572	142.2	3.528	47.8	0.108	48.2	0.241	-164.1
1900.00	0.582	139.6	3.334	44.8	0.113	47.4	0.251	-168.2
2000.00	0.587	137.4	3.161	42.3	0.118	46.6	0.251	-169.9
2100.00	0.594	134.7	2.992	39.4	0.123	45.5	0.268	-174.0
2200.00	0.603	132.7	2.847	36.8	0.128	44.4	0.265	-175.0
2300.00	0.607	130.3	2.695	34.4	0.132	43.5	0.285	-179.0
2400.00	0.618	128.1	2.564	31.8	0.136	42.9	0.280	-178.5
2500.00	0.617	126.1	2.459	29.9	0.140	42.0	0.302	177.6
2600.00	0.628	123.9	2.339	27.6	0.146	40.9	0.302	177.7
2700.00	0.633	122.5	2.263	24.8	0.150	40.0	0.326	174.6
2800.00	0.641	120.0	2.165	23.1	0.155	38.9	0.328	173.7
2900.00	0.648	118.6	2.077	20.5	0.160	37.4	0.346	171.5
3000.00	0.652	116.4	2.003	18.9	0.164	36.1	0.352	169.7



2SC5455 S PARAMETER

V<sub>CE</sub> = 5.0 V, I<sub>c</sub> = 5.0 mA, Z<sub>0</sub> = 50 Ω

FREQUENCY MHz	S <sub>11</sub>		S <sub>21</sub>		S <sub>12</sub>		S <sub>22</sub>	
	MAG	ANG	MAG	ANG	MAG	ANG	MAG	ANG
100.00	0.858	-28.0	14.245	160.5	0.025	74.0	0.949	-16.1
200.00	0.800	-53.2	12.754	143.3	0.044	60.6	0.856	-30.3
300.00	0.739	-75.8	11.353	130.1	0.057	50.2	0.753	-41.4
400.00	0.691	-93.6	9.639	119.6	0.066	42.7	0.657	-50.2
500.00	0.642	-110.2	8.532	108.8	0.072	37.7	0.582	-56.0
600.00	0.611	-123.8	7.532	101.1	0.075	34.1	0.525	-61.3
700.00	0.590	-135.1	6.650	94.3	0.077	31.4	0.475	-66.2
800.00	0.575	-145.2	5.962	88.4	0.079	29.3	0.444	-69.7
900.00	0.567	-153.7	5.351	83.1	0.080	28.0	0.410	-73.9
1000.00	0.562	-161.3	4.876	78.0	0.081	27.5	0.388	-77.1
1100.00	0.561	-168.0	4.466	73.7	0.082	27.0	0.370	-81.0
1200.00	0.560	-174.2	4.115	69.4	0.083	26.6	0.356	-84.3
1300.00	0.565	-179.7	3.806	65.4	0.085	27.1	0.346	-88.2
1400.00	0.567	175.1	3.546	61.5	0.085	27.4	0.337	-91.9
1500.00	0.572	170.3	3.330	58.0	0.086	27.9	0.331	-96.0
1600.00	0.578	166.0	3.106	54.2	0.088	28.5	0.329	-99.5
1700.00	0.585	161.9	2.946	50.2	0.089	29.5	0.326	-104.1
1800.00	0.592	158.1	2.766	47.3	0.090	30.2	0.329	-107.4
1900.00	0.600	154.3	2.623	43.5	0.093	30.7	0.326	-112.9
2000.00	0.607	151.1	2.484	40.2	0.095	31.9	0.329	-115.1
2100.00	0.614	147.5	2.357	36.8	0.097	32.8	0.334	-121.1
2200.00	0.622	144.5	2.249	33.6	0.100	33.4	0.340	-122.7
2300.00	0.626	141.5	2.125	30.5	0.102	34.0	0.342	-128.6
2400.00	0.635	138.5	2.028	27.3	0.106	34.7	0.351	-129.8
2500.00	0.637	135.9	1.940	24.8	0.109	35.9	0.360	-135.2
2600.00	0.645	133.2	1.842	21.8	0.113	36.3	0.372	-136.4
2700.00	0.651	131.1	1.782	18.7	0.118	36.7	0.387	-142.2
2800.00	0.657	128.4	1.696	16.2	0.121	36.3	0.396	-144.2
2900.00	0.664	126.4	1.625	13.2	0.127	36.3	0.415	-148.4
3000.00	0.668	124.0	1.557	11.1	0.131	36.0	0.419	-151.6

V<sub>CE</sub> = 5.0 V, I<sub>c</sub> = 10.0 mA, Z<sub>0</sub> = 50 Ω

FREQUENCY MHz	S <sub>11</sub>		S <sub>21</sub>		S <sub>12</sub>		S <sub>22</sub>	
	MAG	ANG	MAG	ANG	MAG	ANG	MAG	ANG
100.00	0.756	-39.2	23.248	154.1	0.022	70.0	0.899	-23.7
200.00	0.680	-71.6	19.314	134.2	0.038	56.1	0.751	-42.3
300.00	0.616	-97.0	15.939	120.0	0.046	47.1	0.615	-55.1
400.00	0.578	-116.3	12.974	110.2	0.052	42.9	0.515	-64.5
500.00	0.548	-131.4	10.940	101.0	0.056	40.6	0.440	-70.8
600.00	0.532	-143.4	9.424	94.4	0.059	39.4	0.388	-76.2
700.00	0.532	-153.4	8.187	88.8	0.062	38.7	0.344	-81.1
800.00	0.520	-161.6	7.256	83.8	0.065	38.5	0.318	-85.8
900.00	0.518	-168.8	6.480	79.4	0.068	38.7	0.294	-90.3
1000.00	0.520	-175.2	5.861	75.2	0.071	39.1	0.277	-94.3
1100.00	0.522	179.2	5.342	71.3	0.074	39.4	0.264	-98.9
1200.00	0.525	174.0	4.906	67.7	0.077	39.9	0.255	-102.7
1300.00	0.531	169.5	4.535	64.2	0.080	40.3	0.250	-107.3
1400.00	0.536	165.1	4.213	60.8	0.084	40.8	0.244	-111.7
1500.00	0.543	161.2	3.949	57.5	0.087	40.6	0.242	-116.3
1600.00	0.550	157.5	3.685	54.4	0.091	40.7	0.243	-120.2
1700.00	0.558	154.1	3.483	51.0	0.094	41.1	0.244	-125.0
1800.00	0.564	150.9	3.289	47.9	0.097	40.9	0.247	-128.5
1900.00	0.573	147.7	3.098	44.6	0.101	40.7	0.250	-134.3
2000.00	0.578	145.0	2.942	41.9	0.104	40.5	0.254	-136.1
2100.00	0.587	141.8	2.791	38.6	0.109	40.6	0.264	-141.7
2200.00	0.596	139.4	2.646	35.8	0.112	40.0	0.265	-142.7
2300.00	0.601	136.6	2.515	33.1	0.116	40.0	0.277	-149.1
2400.00	0.611	134.0	2.396	30.1	0.120	39.6	0.279	-148.5
2500.00	0.612	131.7	2.302	28.0	0.124	39.6	0.295	-153.8
2600.00	0.622	129.2	2.189	25.2	0.128	39.3	0.299	-154.0
2700.00	0.627	127.5	2.116	22.3	0.134	38.9	0.320	-159.2
2800.00	0.635	125.0	2.020	20.2	0.138	37.7	0.328	-160.8
2900.00	0.642	123.1	1.936	17.3	0.144	36.9	0.347	-164.3
3000.00	0.647	120.9	1.861	15.5	0.148	36.4	0.352	-166.7

2SC5455 S PARAMETER

V<sub>CE</sub> = 5.0 V, I<sub>c</sub> = 20.0 mA, Z<sub>0</sub> = 50 Ω

FREQUENCY MHz	S <sub>11</sub>		S <sub>21</sub>		S <sub>12</sub>		S <sub>22</sub>	
	MAG	ANG	MAG	ANG	MAG	ANG	MAG	ANG
100.00	0.635	-54.4	33.512	146.5	0.020	66.2	0.830	-33.2
200.00	0.566	-93.3	25.234	124.9	0.031	53.6	0.630	-55.1
300.00	0.526	-118.9	19.353	111.5	0.037	48.0	0.485	-69.0
400.00	0.505	-136.8	15.238	102.7	0.042	47.5	0.395	-79.0
500.00	0.498	-149.4	12.561	95.2	0.046	47.1	0.332	-86.2
600.00	0.493	-159.3	10.646	89.6	0.050	47.4	0.294	-92.5
700.00	0.492	-167.5	9.192	84.9	0.054	48.0	0.263	-98.6
800.00	0.494	-174.2	8.090	80.6	0.058	48.6	0.243	-103.6
900.00	0.497	179.8	7.203	76.9	0.062	49.0	0.229	-109.7
1000.00	0.501	174.5	6.487	73.1	0.068	49.6	0.219	-114.4
1100.00	0.505	170.0	5.907	69.8	0.072	49.5	0.213	-119.6
1200.00	0.511	165.6	5.426	66.6	0.076	49.2	0.208	-124.6
1300.00	0.518	161.8	5.010	63.5	0.081	48.9	0.209	-129.5
1400.00	0.524	158.1	4.651	60.3	0.086	49.0	0.208	-133.9
1500.00	0.531	154.7	4.343	57.4	0.090	48.4	0.211	-138.7
1600.00	0.537	151.5	4.071	54.4	0.095	48.0	0.216	-141.7
1700.00	0.546	148.7	3.819	51.4	0.099	47.6	0.221	-146.9
1800.00	0.552	145.9	3.607	48.5	0.103	46.7	0.224	-149.5
1900.00	0.561	143.0	3.402	45.5	0.108	46.2	0.234	-154.6
2000.00	0.567	140.7	3.235	42.9	0.112	45.3	0.236	-156.4
2100.00	0.576	137.8	3.060	40.1	0.117	44.8	0.249	-161.6
2200.00	0.585	135.7	2.916	37.2	0.121	43.7	0.250	-162.2
2300.00	0.589	133.1	2.763	34.7	0.126	43.2	0.266	-167.5
2400.00	0.600	130.8	2.631	32.0	0.130	42.4	0.264	-166.9
2500.00	0.601	128.7	2.524	30.0	0.134	41.7	0.284	-171.1
2600.00	0.611	126.5	2.407	27.7	0.139	41.1	0.285	-170.9
2700.00	0.616	124.9	2.325	24.8	0.144	40.3	0.308	-175.1
2800.00	0.625	122.4	2.226	22.9	0.149	39.0	0.314	-175.8
2900.00	0.632	120.9	2.135	20.2	0.154	37.8	0.331	-178.6
3000.00	0.636	118.6	2.057	18.5	0.158	36.8	0.337	179.3

V<sub>CE</sub> = 5.0 V, I<sub>c</sub> = 30.0 mA, Z<sub>0</sub> = 50 Ω

FREQUENCY MHz	S <sub>11</sub>		S <sub>21</sub>		S <sub>12</sub>		S <sub>22</sub>	
	MAG	ANG	MAG	ANG	MAG	ANG	MAG	ANG
100.00	0.572	-64.3	38.635	142.3	0.018	64.8	0.780	-38.5
200.00	0.521	-105.1	27.544	120.4	0.028	53.5	0.567	-61.5
300.00	0.496	-129.7	20.521	107.8	0.033	50.0	0.427	-75.6
400.00	0.487	-146.1	15.977	99.8	0.038	50.1	0.346	-86.2
500.00	0.485	-157.1	13.055	92.9	0.043	50.5	0.291	-94.3
600.00	0.484	-166.1	11.019	87.8	0.047	51.4	0.260	-100.7
700.00	0.486	-173.3	9.493	83.2	0.052	52.7	0.235	-107.4
800.00	0.489	-179.3	8.343	79.4	0.057	52.8	0.219	-113.0
900.00	0.493	175.2	7.411	75.8	0.062	53.3	0.210	-119.7
1000.00	0.499	170.5	6.670	72.2	0.067	53.1	0.205	-124.6
1100.00	0.504	166.5	6.077	69.0	0.072	53.2	0.200	-130.2
1200.00	0.510	162.3	5.575	66.0	0.077	52.6	0.199	-135.0
1300.00	0.516	158.9	5.148	63.1	0.082	52.7	0.203	-139.3
1400.00	0.522	155.3	4.785	60.0	0.086	51.9	0.204	-143.3
1500.00	0.529	152.2	4.465	57.2	0.092	51.1	0.209	-147.8
1600.00	0.536	149.2	4.169	54.4	0.097	50.6	0.213	-151.5
1700.00	0.544	146.4	3.928	51.4	0.101	49.8	0.221	-155.4
1800.00	0.551	143.8	3.715	48.6	0.106	48.9	0.224	-158.4
1900.00	0.560	141.0	3.496	45.7	0.111	47.9	0.235	-163.5
2000.00	0.565	138.9	3.326	43.0	0.115	47.1	0.239	-164.2
2100.00	0.574	136.0	3.136	40.2	0.120	46.4	0.253	-168.8
2200.00	0.583	134.3	2.992	37.7	0.125	45.1	0.251	-169.9
2300.00	0.586	131.6	2.835	35.1	0.129	44.4	0.268	-174.6
2400.00	0.599	129.5	2.700	32.5	0.134	43.3	0.265	-173.3
2500.00	0.599	127.4	2.599	30.7	0.138	42.7	0.288	-177.8
2600.00	0.611	125.2	2.462	28.1	0.143	41.7	0.288	-177.6
2700.00	0.614	123.7	2.382	25.6	0.148	40.7	0.310	178.8
2800.00	0.623	121.3	2.285	23.9	0.153	39.4	0.316	178.0
2900.00	0.631	119.8	2.188	21.2	0.158	38.1	0.331	175.3
3000.00	0.635	117.6	2.115	19.5	0.162	37.0	0.338	173.9

[MEMO]

[MEMO]

[MEMO]

No part of this document may be copied or reproduced in any form or by any means without the prior written consent of NEC Corporation. NEC Corporation assumes no responsibility for any errors which may appear in this document.

NEC Corporation does not assume any liability for infringement of patents, copyrights or other intellectual property rights of third parties by or arising from use of a device described herein or any other liability arising from use of such device. No license, either express, implied or otherwise, is granted under any patents, copyrights or other intellectual property rights of NEC Corporation or others.

While NEC Corporation has been making continuous effort to enhance the reliability of its semiconductor devices, the possibility of defects cannot be eliminated entirely. To minimize risks of damage or injury to persons or property arising from a defect in an NEC semiconductor device, customers must incorporate sufficient safety measures in its design, such as redundancy, fire-containment, and anti-failure features.

NEC devices are classified into the following three quality grades:

"Standard", "Special", and "Specific". The Specific quality grade applies only to devices developed based on a customer designated "quality assurance program" for a specific application. The recommended applications of a device depend on its quality grade, as indicated below. Customers must check the quality grade of each device before using it in a particular application.

Standard: Computers, office equipment, communications equipment, test and measurement equipment, audio and visual equipment, home electronic appliances, machine tools, personal electronic equipment and industrial robots

Special: Transportation equipment (automobiles, trains, ships, etc.), traffic control systems, anti-disaster systems, anti-crime systems, safety equipment and medical equipment (not specifically designed for life support)

Specific: Aircrafts, aerospace equipment, submersible repeaters, nuclear reactor control systems, life support systems or medical equipment for life support, etc.

The quality grade of NEC devices is "Standard" unless otherwise specified in NEC's Data Sheets or Data Books. If customers intend to use NEC devices for applications other than those specified for Standard quality grade, they should contact an NEC sales representative in advance.

Anti-radioactive design is not implemented in this product.