

# MBRB30H60CT-1G, MBR30H60CTG, MBRF30H60CTG

## SWITCHMODE™ Power Rectifier 60 V, 30 A

### Features and Benefits

- Low Forward Voltage
- Low Power Loss/High Efficiency
- High Surge Capacity
- 175°C Operating Junction Temperature
- 30 A Total (15 A Per Diode Leg)
- Guard-Ring for Stress Protection
- These are Pb-Free Devices\*

### Applications

- Power Supply – Output Rectification
- Power Management
- Instrumentation

### Mechanical Characteristics:

- Case: Epoxy, Molded
- Epoxy Meets UL 94 V-0 @ 0.125 in
- Weight (Approximately): 1.5 Grams (I<sup>2</sup>PAK)  
1.9 Grams (TO-220 and TO-220FP)
- Finish: All External Surfaces Corrosion Resistant and Terminal Leads are Readily Solderable
- Lead Temperature for Soldering Purposes:  
260°C Max. for 10 Seconds

### MAXIMUM RATINGS

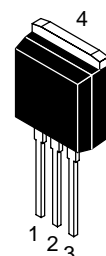
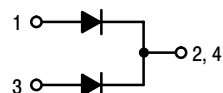
Please See the Table on the Following Page



ON Semiconductor®

<http://onsemi.com>

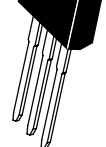
## SCHOTTKY BARRIER RECTIFIERS 30 AMPERES, 60 VOLTS



I<sup>2</sup>PAK (TO-262)  
CASE 418D  
PLASTIC  
STYLE 3



TO-220  
CASE 221A  
PLASTIC  
STYLE 6



TO-220  
CASE 221D  
STYLE 3

### MARKING DIAGRAMS



B30H60 = Device Code  
A = Assembly Location  
Y = Year  
WV = Work Week  
G = Pb-Free Package  
AKA = Polarity Designator

### ORDERING INFORMATION

Device	Package	Shipping
MBRB30H60CT-1G	TO-262 (Pb-Free)	50 Units/Rail
MBR30H60CTG	TO-220 (Pb-Free)	50 Units/Rail
MBRF30H60CTG	TO-220FP (Pb-Free)	50 Units/Rail

\*For additional information on our Pb-Free strategy and soldering details, please download the ON Semiconductor Soldering and Mounting Techniques Reference Manual, SOLDERRM/D.

# MBRB30H60CT-1G, MBR30H60CTG, MBRF30H60CTG

## MAXIMUM RATINGS (Per Diode Leg)

Rating	Symbol	Value	Unit
Peak Repetitive Reverse Voltage Working Peak Reverse Voltage DC Blocking Voltage	$V_{RRM}$ $V_{RWM}$ $V_R$	60	V
Average Rectified Forward Current (Rated $V_R$ ) $T_C = 159^\circ\text{C}$	$I_{F(AV)}$	15	A
Peak Repetitive Forward Current (Rated $V_R$ , Square Wave, 20 kHz)	$I_{FRM}$	30	A
Nonrepetitive Peak Surge Current (Surge applied at rated load conditions halfwave, single phase, 60 Hz)	$I_{FSM}$	260	A
Operating Junction Temperature (Note 1)	$T_J$	-55 to +175	$^\circ\text{C}$
Storage Temperature	$T_{stg}$	-55 to +175	$^\circ\text{C}$
Voltage Rate of Change (Rated $V_R$ )	$dv/dt$	10,000	V/ $\mu\text{s}$
Controlled Avalanche Energy (see test conditions in Figures 10 and 11)	$W_{AVAL}$	350	mJ
ESD Ratings: Machine Model = C Human Body Model = 3B		> 400 > 8000	V

## THERMAL CHARACTERISTICS

Maximum Thermal Resistance (MBRB30H60CT-1G and MBR30H60CTG) – Junction-to-Case – Junction-to-Ambient (MBRF30H60CTG) – Junction-to-Case	$R_{\theta JC}$ $R_{\theta JA}$ $R_{\theta JC}$	2.0 70 2.5	$^\circ\text{C/W}$
---	---	------------------	--------------------

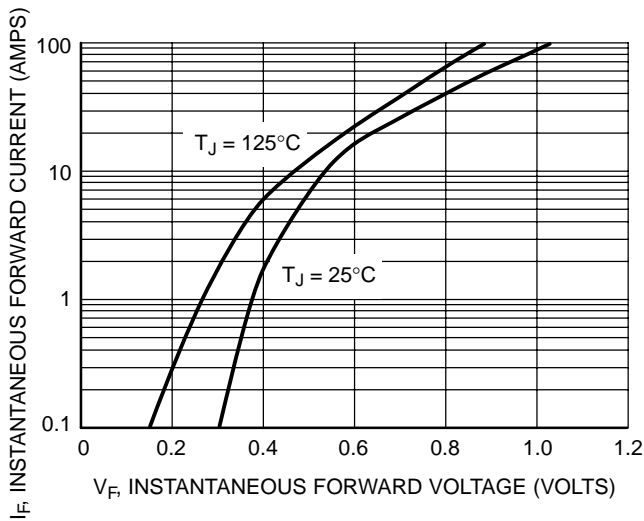
## ELECTRICAL CHARACTERISTICS (Per Diode Leg)

Maximum Instantaneous Forward Voltage (Note 2) ( $I_F = 15\text{ A}$ , $T_C = 25^\circ\text{C}$ ) ( $I_F = 15\text{ A}$ , $T_C = 125^\circ\text{C}$ ) ( $I_F = 30\text{ A}$ , $T_C = 25^\circ\text{C}$ ) ( $I_F = 30\text{ A}$ , $T_C = 125^\circ\text{C}$ )	$V_F$	0.62 0.56 0.78 0.71	V
Maximum Instantaneous Reverse Current (Note 2) (Rated DC Voltage, $T_C = 25^\circ\text{C}$ ) (Rated DC Voltage, $T_C = 125^\circ\text{C}$ )	$i_R$	0.3 45	mA

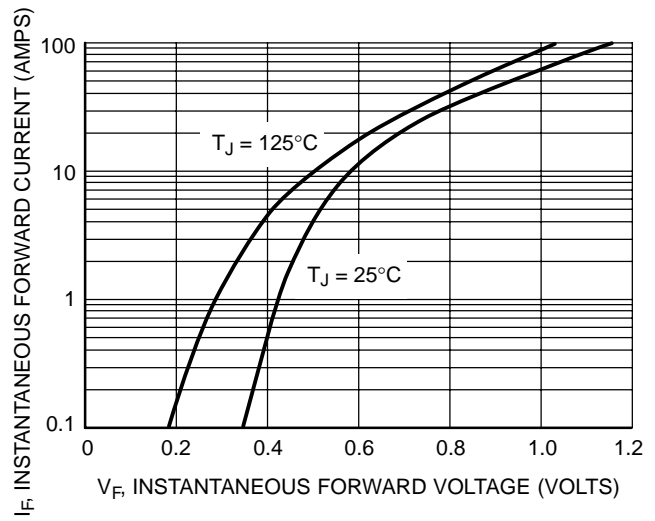
Stresses exceeding Maximum Ratings may damage the device. Maximum Ratings are stress ratings only. Functional operation above the Recommended Operating Conditions is not implied. Extended exposure to stresses above the Recommended Operating Conditions may affect device reliability.

- The heat generated must be less than the thermal conductivity from Junction-to-Ambient:  $dP_D/dT_J < 1/R_{\theta JA}$ .
- Pulse Test: Pulse Width = 300  $\mu\text{s}$ , Duty Cycle  $\leq 2.0\%$ .

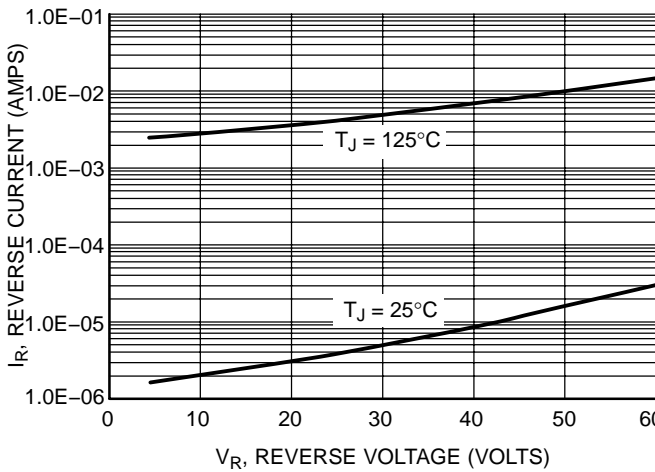
**MBRB30H60CT-1G, MBR30H60CTG, MBRF30H60CTG**



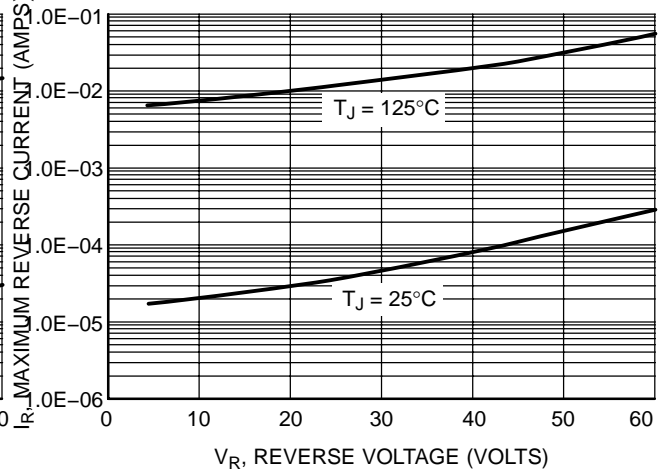
**Figure 1. Typical Forward Voltage**



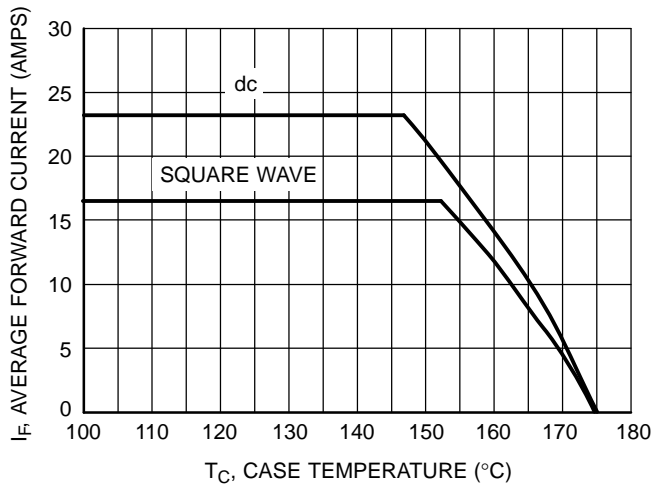
**Figure 2. Maximum Forward Voltage**



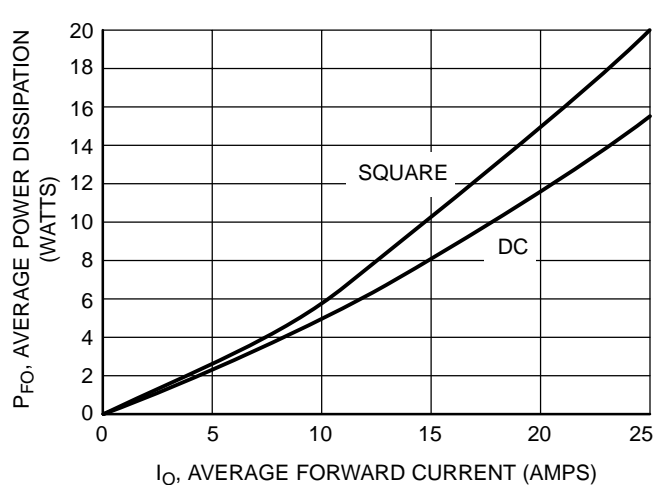
**Figure 3. Typical Reverse Current**



**Figure 4. Maximum Reverse Current**

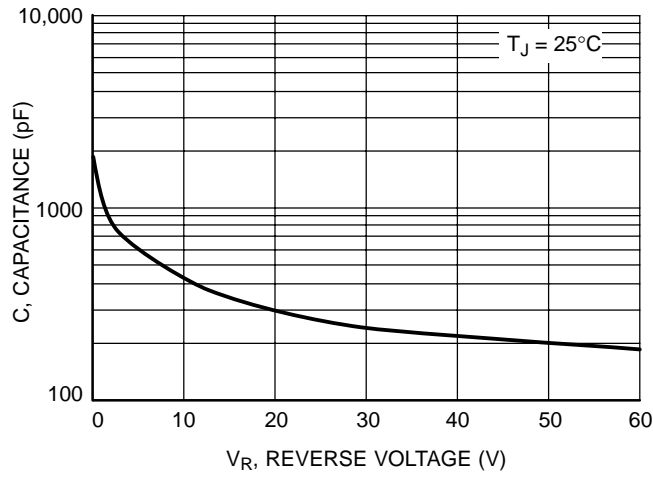


**Figure 5. Current Derating**

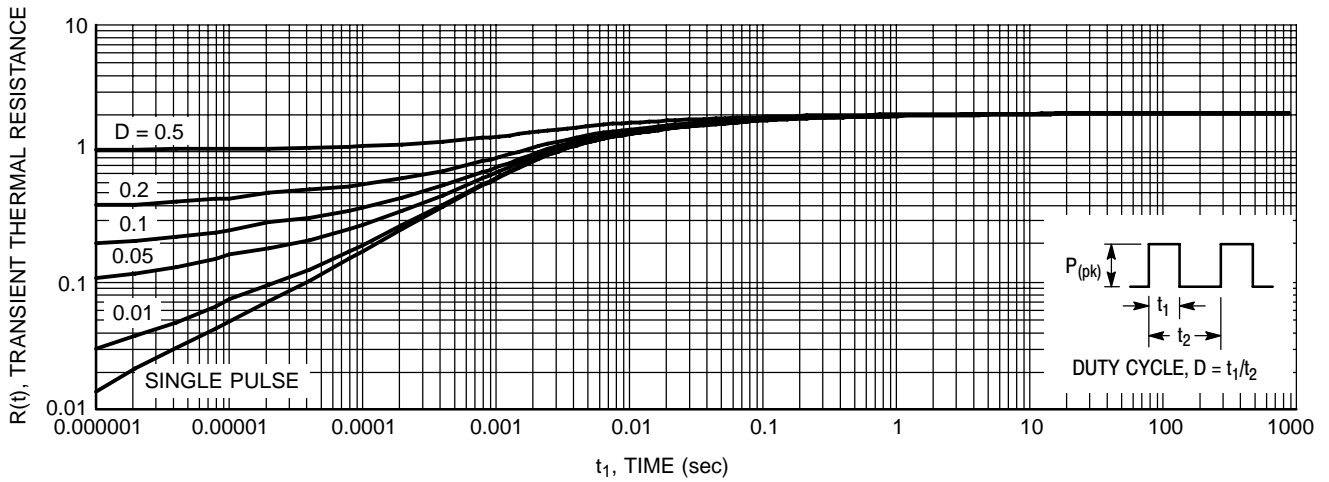


**Figure 6. Forward Power Dissipation**

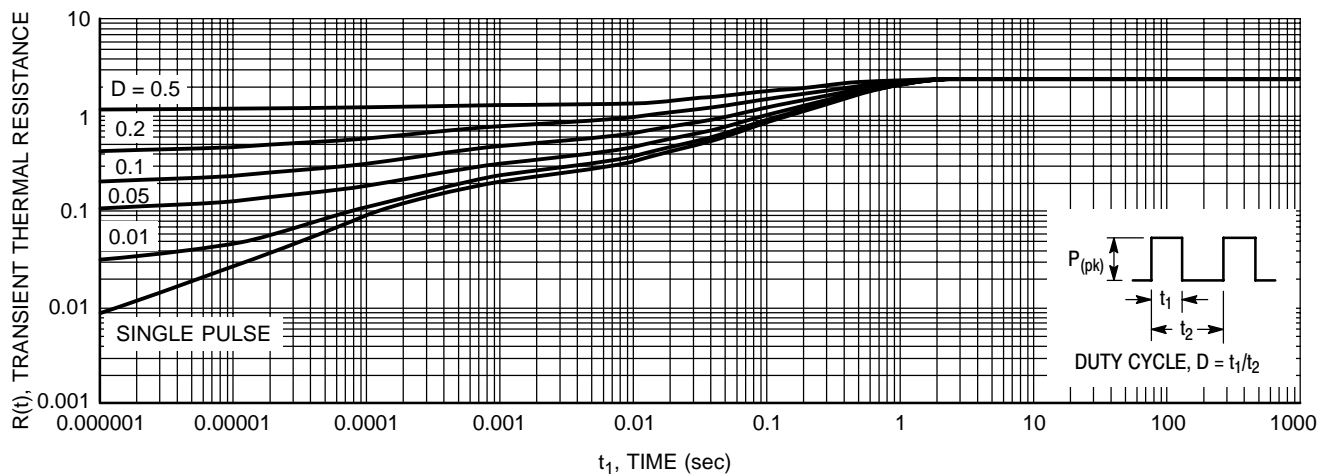
**MBRB30H60CT-1G, MBR30H60CTG, MBRF30H60CTG**



**Figure 7. Capacitance**



**Figure 8. Thermal Response Junction-to-Case for MBRB30H60CT-1G and MBR30H60CTG**



**Figure 9. Thermal Response Junction-to-Case for MBRF30H60CTG**

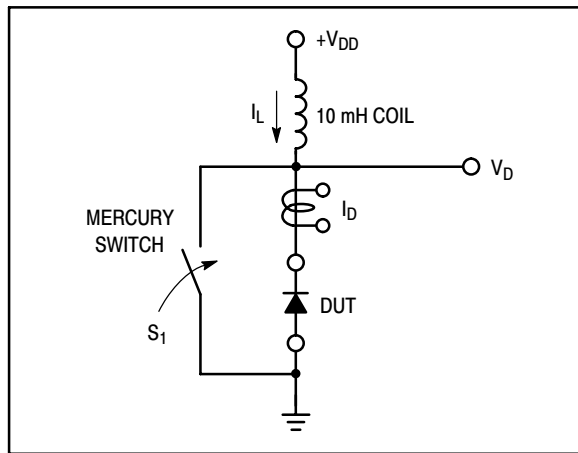


Figure 10. Test Circuit

The unclamped inductive switching circuit shown in Figure 10 was used to demonstrate the controlled avalanche capability of this device. A mercury switch was used instead of an electronic switch to simulate a noisy environment when the switch was being opened.

When  $S_1$  is closed at  $t_0$  the current in the inductor  $I_L$  ramps up linearly; and energy is stored in the coil. At  $t_1$  the switch is opened and the voltage across the diode under test begins to rise rapidly, due to  $di/dt$  effects, when this induced voltage reaches the breakdown voltage of the diode, it is clamped at  $BV_{DUT}$  and the diode begins to conduct the full load current which now starts to decay linearly through the diode, and goes to zero at  $t_2$ .

By solving the loop equation at the point in time when  $S_1$  is opened; and calculating the energy that is transferred to the diode it can be shown that the total energy transferred is equal to the energy stored in the inductor plus a finite amount of energy from the  $V_{DD}$  power supply while the diode is in breakdown (from  $t_1$  to  $t_2$ ) minus any losses due to finite component resistances. Assuming the component resistive

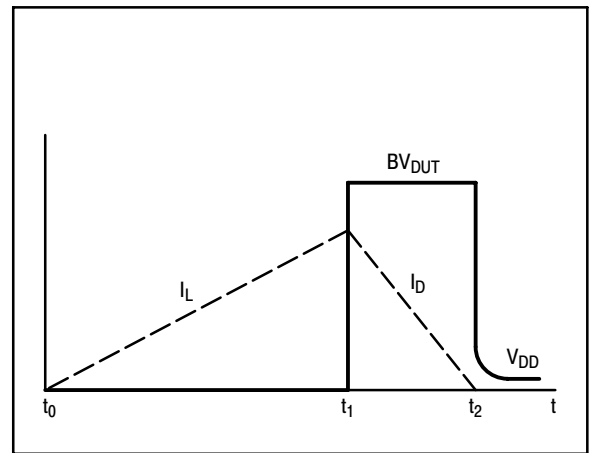


Figure 11. Current-Voltage Waveforms

elements are small Equation (1) approximates the total energy transferred to the diode. It can be seen from this equation that if the  $V_{DD}$  voltage is low compared to the breakdown voltage of the device, the amount of energy contributed by the supply during breakdown is small and the total energy can be assumed to be nearly equal to the energy stored in the coil during the time when  $S_1$  was closed, Equation (2).

EQUATION (1):

$$W_{AVAL} \approx \frac{1}{2} L I_{LPK}^2 \left( \frac{BV_{DUT}}{BV_{DUT} - V_{DD}} \right)$$

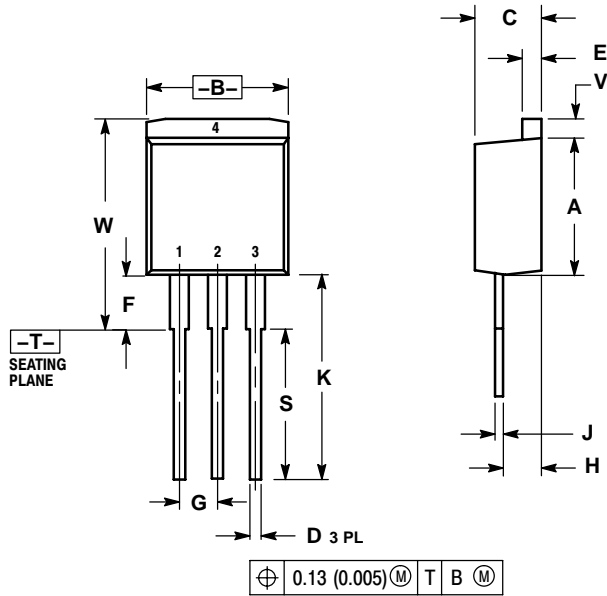
EQUATION (2):

$$W_{AVAL} \approx \frac{1}{2} L I_{LPK}^2$$

# MBRB30H60CT-1G, MBR30H60CTG, MBRF30H60CTG

## PACKAGE DIMENSIONS

I<sup>2</sup>PAK (TO-262)  
CASE 418D-01  
ISSUE C

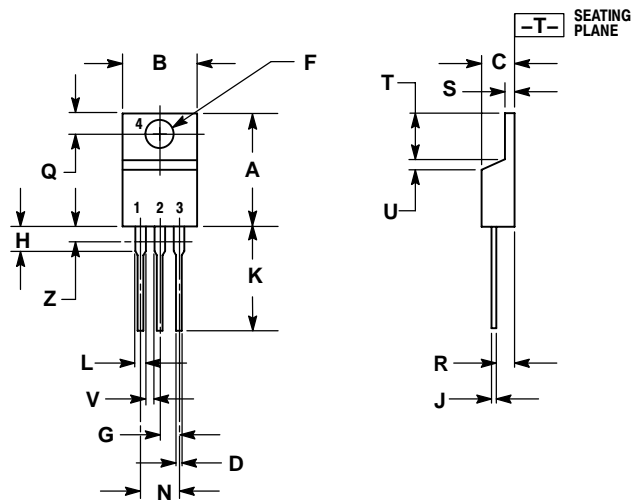


- NOTES:  
1. DIMENSIONING AND TOLERANCING PER ANSI Y14.5M, 1982.  
2. CONTROLLING DIMENSION: INCH.

DIM	INCHES		MILLIMETERS	
	MIN	MAX	MIN	MAX
A	0.335	0.380	8.51	9.65
B	0.380	0.406	9.65	10.31
C	0.160	0.185	4.06	4.70
D	0.026	0.035	0.66	0.89
E	0.045	0.055	1.14	1.40
F	0.122	REF	3.10	REF
G	0.100	BSC	2.54	BSC
H	0.094	0.110	2.39	2.79
J	0.013	0.025	0.33	0.64
K	0.500	0.562	12.70	14.27
S	0.390	REF	9.90	REF
V	0.045	0.070	1.14	1.78
W	0.522	0.551	13.25	14.00

- STYLE 3:  
PIN 1. ANODE  
2. CATHODE  
3. ANODE  
4. CATHODE

TO-220  
CASE 221A-09  
ISSUE AD



- NOTES:  
1. DIMENSIONING AND TOLERANCING PER ANSI Y14.5M, 1982.  
2. CONTROLLING DIMENSION: INCH.  
3. DIMENSION Z DEFINES A ZONE WHERE ALL BODY AND LEAD IRREGULARITIES ARE ALLOWED.

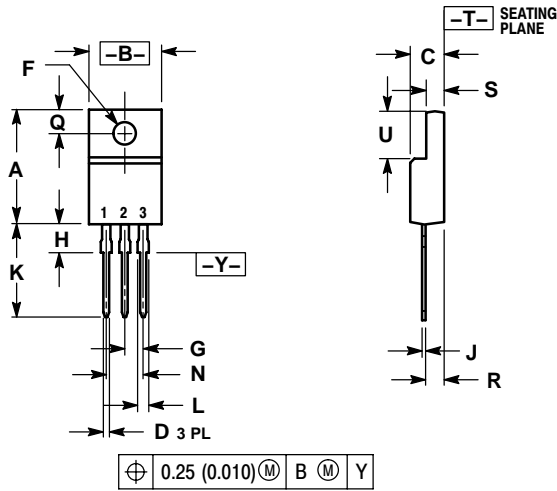
DIM	INCHES		MILLIMETERS	
	MIN	MAX	MIN	MAX
A	0.570	0.620	14.48	15.75
B	0.380	0.405	9.66	10.28
C	0.160	0.190	4.07	4.82
D	0.025	0.035	0.64	0.88
F	0.142	0.147	3.61	3.73
G	0.095	0.105	2.42	2.66
H	0.110	0.155	2.80	3.93
J	0.018	0.025	0.46	0.64
K	0.500	0.562	12.70	14.27
L	0.045	0.060	1.15	1.52
N	0.190	0.210	4.83	5.33
Q	0.100	0.120	2.54	3.04
R	0.080	0.110	2.04	2.79
S	0.045	0.055	1.15	1.39
T	0.235	0.255	5.97	6.47
U	0.000	0.050	0.00	1.27
V	0.045	---	1.15	---
Z	---	0.080	---	2.04

- STYLE 6:  
PIN 1. ANODE  
2. CATHODE  
3. ANODE  
4. CATHODE

# MBRB30H60CT-1G, MBR30H60CTG, MBRF30H60CTG

## PACKAGE DIMENSIONS

TO-220 FULLPAK  
CASE 221D-03  
ISSUE H



- NOTES:
1. DIMENSIONING AND TOLERANCING PER ANSI Y14.5M, 1982.
  2. CONTROLLING DIMENSION: INCH
  3. 221D-01 THRU 221D-02 OBSOLETE, NEW STANDARD 221D-03.

DIM	INCHES		MILLIMETERS	
	MIN	MAX	MIN	MAX
A	0.625	0.635	15.88	16.12
B	0.408	0.418	10.37	10.63
C	0.180	0.190	4.57	4.83
D	0.026	0.031	0.65	0.78
F	0.116	0.119	2.95	3.02
G	0.100 BSC		2.54 BSC	
H	0.125	0.135	3.18	3.43
J	0.018	0.025	0.45	0.63
K	0.530	0.540	13.47	13.73
L	0.048	0.053	1.23	1.36
N	0.200 BSC		5.08 BSC	
Q	0.124	0.128	3.15	3.25
R	0.099	0.103	2.51	2.62
S	0.101	0.113	2.57	2.87
U	0.238	0.258	6.06	6.56

- STYLE 3:
1. ANODE
  2. CATHODE
  3. ANODE

SWITCHMODE is a trademark of Semiconductor Components Industries, LLC.

ON Semiconductor and are registered trademarks of Semiconductor Components Industries, LLC (SCILLC). SCILLC reserves the right to make changes without further notice to any products herein. SCILLC makes no warranty, representation or guarantee regarding the suitability of its products for any particular purpose, nor does SCILLC assume any liability arising out of the application or use of any product or circuit, and specifically disclaims any and all liability, including without limitation special, consequential or incidental damages. "Typical" parameters which may be provided in SCILLC data sheets and/or specifications can and do vary in different applications and actual performance may vary over time. All operating parameters, including "Typicals" must be validated for each customer application by customer's technical experts. SCILLC does not convey any license under its patent rights nor the rights of others. SCILLC products are not designed, intended, or authorized for use as components in systems intended for surgical implant into the body, or other applications intended to support or sustain life, or for any other application in which the failure of the SCILLC product could create a situation where personal injury or death may occur. Should Buyer purchase or use SCILLC products for any such unintended or unauthorized application, Buyer shall indemnify and hold SCILLC and its officers, employees, subsidiaries, affiliates, and distributors harmless against all claims, costs, damages, and expenses, and reasonable attorney fees arising out of, directly or indirectly, any claim of personal injury or death associated with such unintended or unauthorized use, even if such claim alleges that SCILLC was negligent regarding the design or manufacture of the part. SCILLC is an Equal Opportunity/Affirmative Action Employer. This literature is subject to all applicable copyright laws and is not for resale in any manner.

### PUBLICATION ORDERING INFORMATION

**LITERATURE FULFILLMENT:**  
Literature Distribution Center for ON Semiconductor  
P.O. Box 5163, Denver, Colorado 80217 USA  
**Phone:** 303-675-2175 or 800-344-3860 Toll Free USA/Canada  
**Fax:** 303-675-2176 or 800-344-3867 Toll Free USA/Canada  
**Email:** orderlit@onsemi.com

**N. American Technical Support:** 800-282-9855 Toll Free  
USA/Canada  
**Europe, Middle East and Africa Technical Support:**  
Phone: 421 33 790 2910  
**Japan Customer Focus Center**  
Phone: 81-3-5773-3850

**ON Semiconductor Website:** [www.onsemi.com](http://www.onsemi.com)  
**Order Literature:** <http://www.onsemi.com/orderlit>

For additional information, please contact your local Sales Representative

**MBRB30H60CT-1/D**