

**-6A, -80V and -100V, 0.600 Ohm,
P-Channel Power MOSFETs**

These are P-Channel enhancement mode silicon gate power field effect transistors designed for high speed applications such as switching regulators, switching convertors, relay drivers, and drivers for high power bipolar switching transistors.

Formerly developmental type TA09046.

Ordering Information

PART NUMBER	PACKAGE	BRAND
RFP6P08	TO-220AB	RFP6P08
RFP6P10	TO-220AB	RFP6P10

NOTE: When ordering, include the entire part number.

Features

- -6A, -80V and -100V
- $r_{DS(ON)} = 0.600\Omega$
- SOA is Power Dissipation Limited
- Nanosecond Switching Speeds
- Linear Transfer Characteristics
- High Input Impedance
- Majority Carrier Device
- Related Literature
 - TB334 "Guidelines for Soldering Surface Mount Components to PC Boards"

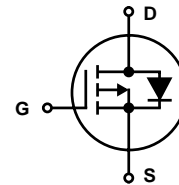
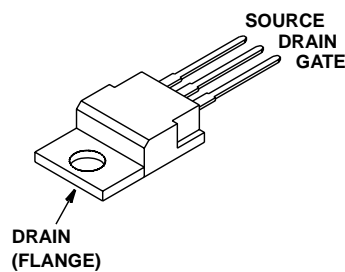
Symbol

Packaging
JEDEC TO-220AB

RFP6P08, RFP6P10

Absolute Maximum Ratings $T_C = 25^\circ\text{C}$, Unless Otherwise Specified

	RFP6P08	RFP6P10	UNITS	
Drain to Source Voltage (Note 1)	V_{DS}	80	100	V
Drain to Gate Voltage ($R_{GS} = 20\text{k}\Omega$) (Note 1)	V_{DGR}	80	100	V
Continuous Drain Current				
RMS Continuous	I_D	6	6	A
Pulsed Drain Current (Note 3)	I_{DM}	20	20	A
Gate to Source Voltage	V_{GS}	± 20	± 20	V
Maximum Power Dissipation	P_D	60	60	W
Linear Derating Factor		0.48	0.48	W/ $^\circ\text{C}$
Operating and Storage Temperature Range	T_J, T_{STG}	-55 to 150	-55 to 150	$^\circ\text{C}$
Maximum Temperature for Soldering				
Leads at 0.063in (1.6mm) from Case for 10s	T_L	300	300	$^\circ\text{C}$
Package Body for 10s, See Techbrief 334 (for TO-220AB)	T_{pkg}	260	260	$^\circ\text{C}$

CAUTION: Stresses above those listed in "Absolute Maximum Ratings" may cause permanent damage to the device. This is a stress only rating and operation of the device at these or any other conditions above those indicated in the operational sections of this specification is not implied.

NOTE:

- $T_J = 25^\circ\text{C}$ to 125°C .

Electrical Specifications $T_C = 25^\circ\text{C}$, Unless Otherwise Specified

PARAMETER	SYMBOL	TEST CONDITIONS	MIN	TYP	MAX	UNITS
Drain to Source Breakdown Voltage	BV_{DSS}	$I_D = 250\mu\text{A}, V_{GS} = 0\text{V}$				
RFP6P08			-80	-	-	V
RFP6P10			-100	-	-	V
Gate Threshold Voltage	$V_{GS(TH)}$	$V_{GS} = V_{DS}, I_D = 250\mu\text{A}$ (Figure 7)	-2	-	-4	V
Zero-Gate Voltage Drain Current	I_{DSS}	$V_{DS} = \text{Rated } BV_{DSS}$	-	-	1	μA
		$V_{DS} = 0.8 \times \text{Rated } BV_{DSS} (T_C = 125^\circ\text{C})$	-	-	25	μA
Gate to Source Leakage Current	I_{GSS}	$V_{GS} = \pm 20\text{V}, V_{DS} = 0\text{V}$	-	-	± 100	nA
Drain to Source On Resistance (Note 2)	$r_{DS(ON)}$	$I_D = 6\text{A}, V_{GS} = -10\text{V}$ (Figures 5, 6)	-	-	0.6	Ω
Drain to Source On Voltage (Note 2)	$V_{DS(ON)}$	$I_D = 6\text{A}, V_{GS} = -10\text{V}$	-	-	-3.6	V
Turn-On Delay Time	$t_{d(ON)}$	$V_{DD} = 50\text{V}, I_D \approx 6\text{A}$	-	11	60	ns
Rise Time	t_r	$R_G = 50\Omega, R_L = 16\Omega$	-	48	100	ns
Turn-Off Delay Time	$t_{d(OFF)}$	$V_{GS} = -10\text{V}$ (Figures 13, 14)	-	102	150	ns
Fall Time	t_f		-	70	100	ns
Input Capacitance	C_{ISS}	$V_{DS} = 25\text{V}$	-	-	800	pF
Output Capacitance	C_{OSS}	$V_{GS} = 0\text{V}$ $f = 1\text{MHz}$	-	-	350	pF
Reverse-Transfer Capacitance	C_{RSS}	(Figure 8)	-	-	150	pF
Thermal Resistance Junction to Case	$R_{\theta JC}$	RFP6P08, RFP6P10	-	-	2.083	$^\circ\text{C/W}$

Source to Drain Diode Specifications

PARAMETER	SYMBOL	TEST CONDITIONS	MIN	TYP	MAX	UNITS
Source to Drain Diode Voltage (Note 2)	V_{SD}	$I_{SD} = -3\text{A}$	-	-	-1.4	V
Reverse Recovery Time	t_{rr}	$I_{SD} = 4\text{A}, dI_{SD}/dt = 50\text{A}/\mu\text{s}$	-	150	-	ns

NOTES:

- Pulse Test: Pulse Duration $\leq 300\mu\text{s}$ max, Duty Cycle $\leq 2\%$.
- Repetitive rating: pulse width limited by maximum junction temperature.

Typical Performance Curves

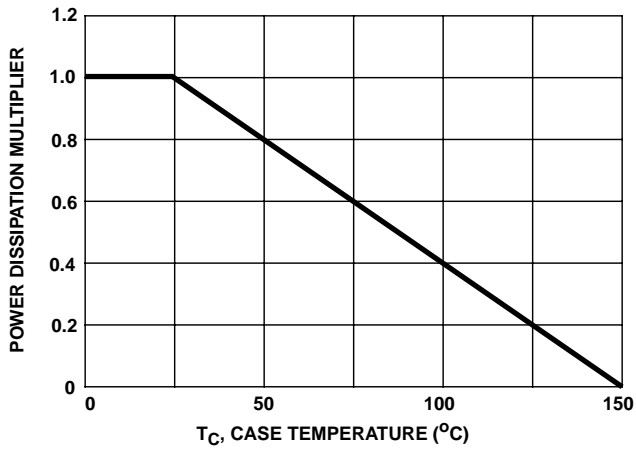

FIGURE 1. NORMALIZED POWER DISSIPATION vs CASE TEMPERATURE

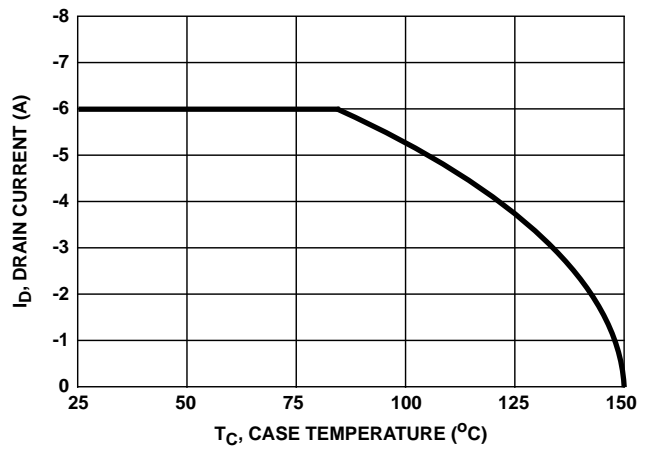

FIGURE 2. MAXIMUM CONTINUOUS DRAIN CURRENT vs CASE TEMPERATURE

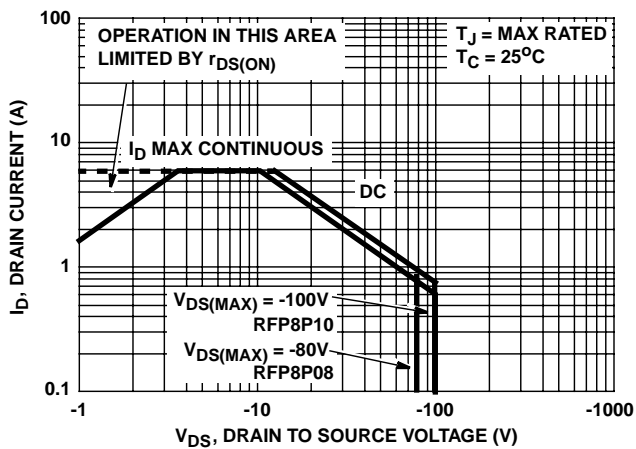

FIGURE 3. FORWARD BIAS SAFE OPERATING AREA

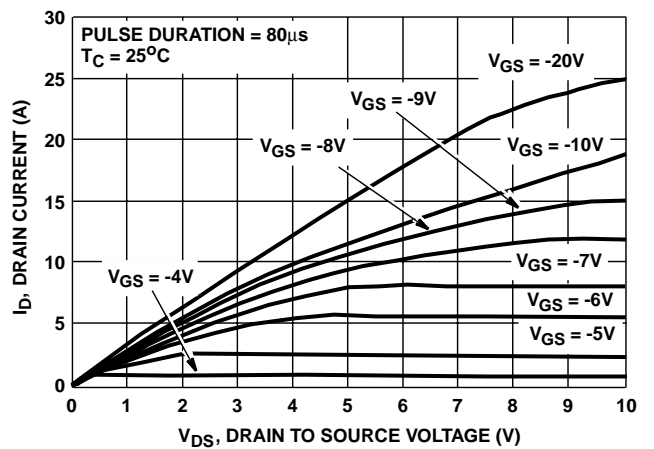

FIGURE 4. SATURATION CHARACTERISTICS

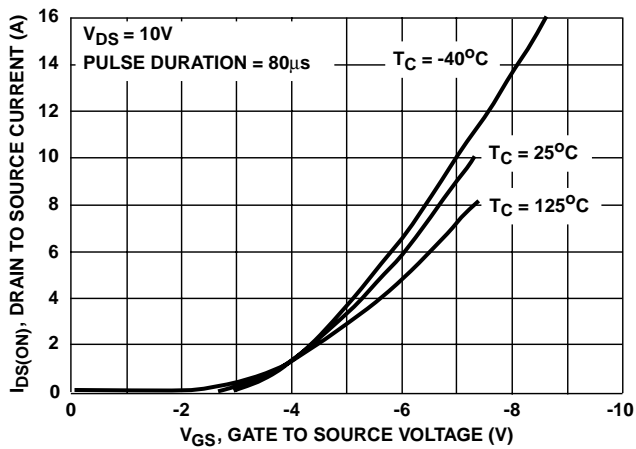

FIGURE 5. TRANSFER CHARACTERISTICS

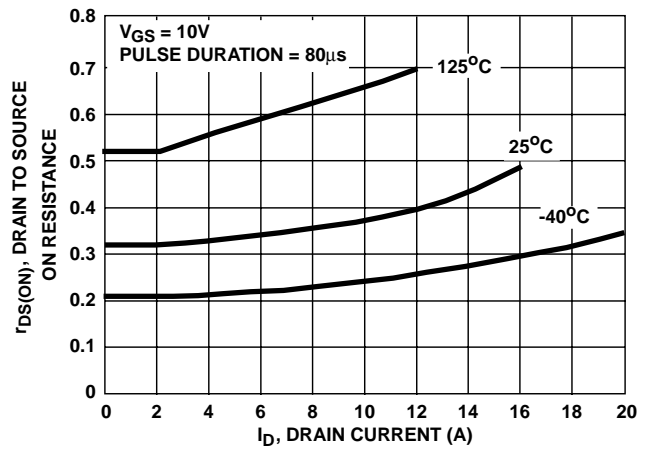

FIGURE 6. DRAIN TO SOURCE ON RESISTANCE vs GATE VOLTAGE AND DRAIN CURRENT

Typical Performance Curves (Continued)

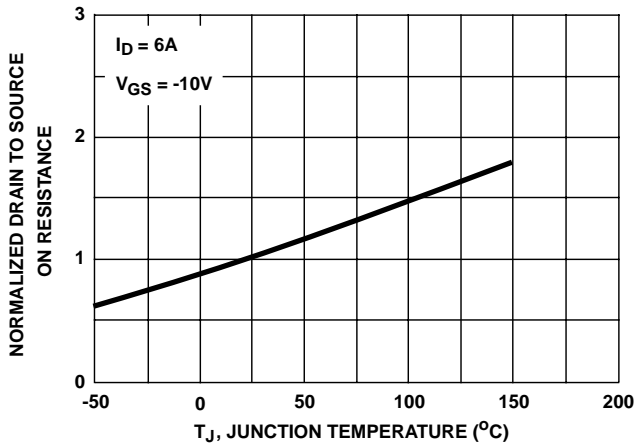

FIGURE 7. NORMALIZED DRAIN TO SOURCE ON RESISTANCE vs JUNCTION TEMPERATURE

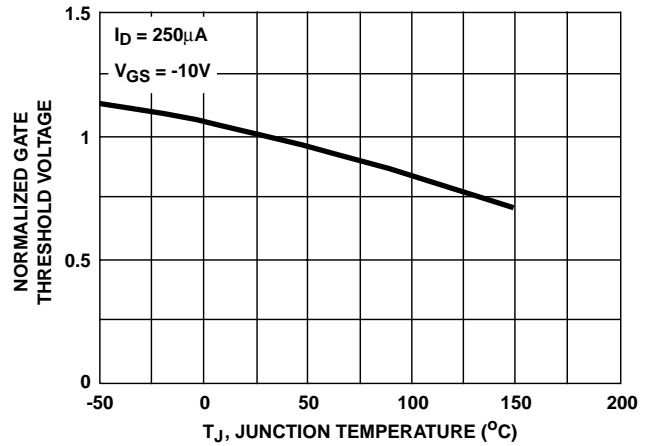

FIGURE 8. NORMALIZED GATE THRESHOLD VOLTAGE vs JUNCTION TEMPERATURE

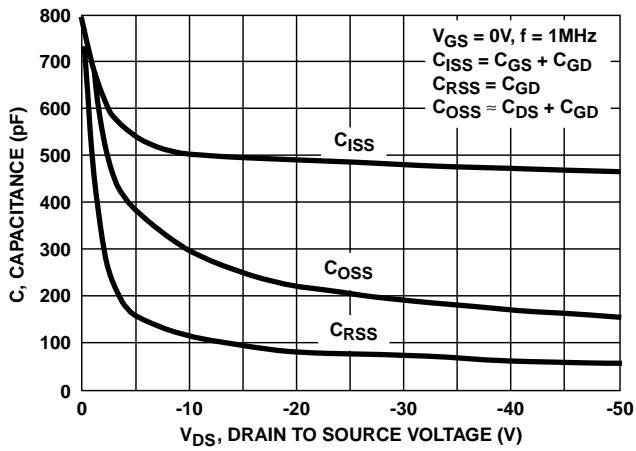
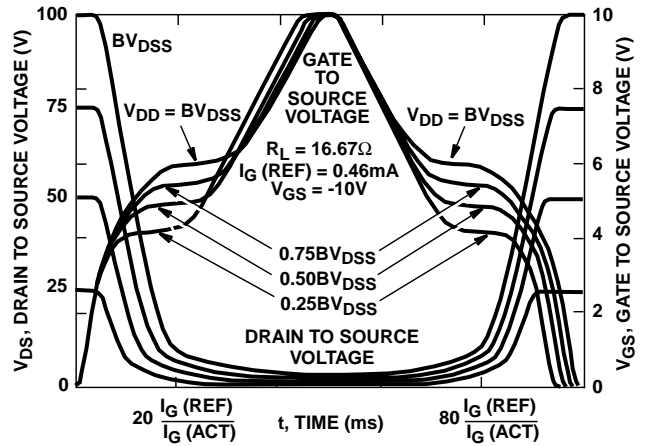

FIGURE 9. CAPACITANCE vs DRAIN TO SOURCE VOLTAGE



NOTE: Refer to Intersil Applications Notes AN7254 and AN7260.

FIGURE 10. NORMALIZED SWITCHING WAVEFORMS FOR CONSTANT GATE CURRENT

Test Circuits and Waveforms

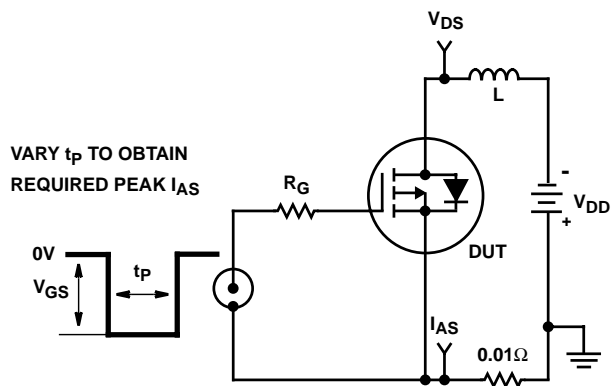

FIGURE 11. UNCLAMPED ENERGY TEST CIRCUIT

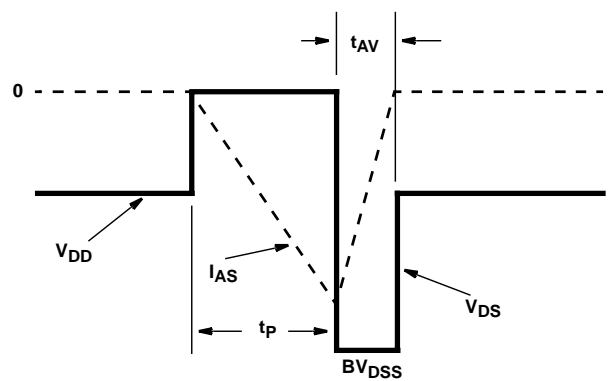

FIGURE 12. UNCLAMPED ENERGY WAVEFORMS

Test Circuits and Waveforms (Continued)

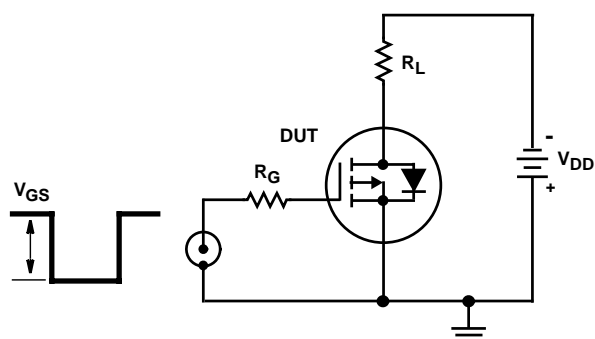

FIGURE 13. SWITCHING TIME TEST CIRCUIT

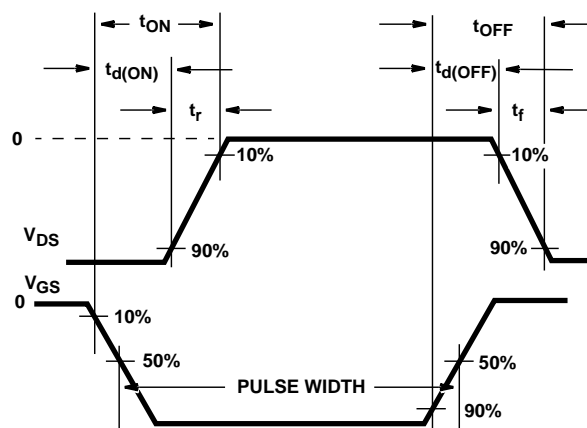

FIGURE 14. RESISTIVE SWITCHING WAVEFORMS

All Intersil semiconductor products are manufactured, assembled and tested under **ISO9000** quality systems certification.

Intersil semiconductor products are sold by description only. Intersil Corporation reserves the right to make changes in circuit design and/or specifications at any time without notice. Accordingly, the reader is cautioned to verify that data sheets are current before placing orders. Information furnished by Intersil is believed to be accurate and reliable. However, no responsibility is assumed by Intersil or its subsidiaries for its use; nor for any infringements of patents or other rights of third parties which may result from its use. No license is granted by implication or otherwise under any patent or patent rights of Intersil or its subsidiaries.

For information regarding Intersil Corporation and its products, see web site www.intersil.com

Sales Office Headquarters

NORTH AMERICA

Intersil Corporation
P. O. Box 883, Mail Stop 53-204
Melbourne, FL 32902
TEL: (407) 724-7000
FAX: (407) 724-7240

EUROPE

Intersil SA
Mercure Center
100, Rue de la Fusee
1130 Brussels, Belgium
TEL: (32) 2.724.2111
FAX: (32) 2.724.22.05

ASIA

Intersil (Taiwan) Ltd.
7F-6, No. 101 Fu Hsing North Road
Taipei, Taiwan
Republic of China
TEL: (886) 2 2716 9310
FAX: (886) 2 2715 3029