

2N3904U

NPN Silicon Epitaxial Planar Transistor

for switching and amplifier applications.

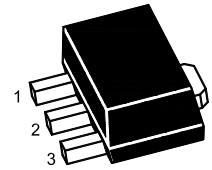

1.Base 2.Collector 3.Emitter
SOT-89 Plastic Package

Absolute Maximum Ratings ($T_a = 25^\circ\text{C}$)

Parameter	Symbol	Value	Unit
Collector Base Voltage	V_{CBO}	60	V
Collector Emitter Voltage	V_{CEO}	40	V
Emitter Base Voltage	V_{EBO}	6	V
Collector Current	I_C	200	mA
Power Dissipation	P_{tot}	500	mW
Junction Temperature	T_j	150	$^\circ\text{C}$
Storage Temperature Range	T_{stg}	- 55 to + 150	$^\circ\text{C}$

Thermal Characteristics

Parameter	Symbol	Max.	Unit
Thermal Resistance from Junction to Ambient ¹⁾	$R_{\theta JA}$	250	$^\circ\text{C/W}$

¹⁾ Device mounted on FR-4 substrate PC board, 2oz copper, with minimum recommended pad layout.

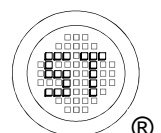

2N3904U

Characteristics at $T_a = 25^\circ\text{C}$

Parameter	Symbol	Min.	Max.	Unit
DC Current Gain				
at $V_{CE} = 1\text{ V}$, $I_C = 0.1\text{ mA}$	h_{FE}	40	-	-
at $V_{CE} = 1\text{ V}$, $I_C = 1\text{ mA}$	h_{FE}	70	-	-
at $V_{CE} = 1\text{ V}$, $I_C = 10\text{ mA}$	h_{FE}	100	300	-
at $V_{CE} = 1\text{ V}$, $I_C = 50\text{ mA}$	h_{FE}	60	-	-
at $V_{CE} = 1\text{ V}$, $I_C = 100\text{ mA}$	h_{FE}	30	-	-
Collector Base Cutoff Current at $V_{CB} = 30\text{ V}$	I_{CBO}	-	50	nA
Emitter Base Cutoff Current at $V_{EB} = 6\text{ V}$	I_{EBO}	-	50	nA
Collector Base Breakdown Voltage at $I_C = 10\text{ }\mu\text{A}$	$V_{(BR)CBO}$	60	-	V
Collector Emitter Breakdown Voltage at $I_C = 1\text{ mA}$	$V_{(BR)CEO}$	40	-	V
Emitter Base Breakdown Voltage at $I_E = 10\text{ }\mu\text{A}$	$V_{(BR)EBO}$	6	-	V
Collector Emitter Saturation Voltage at $I_C = 10\text{ mA}$, $I_B = 1\text{ mA}$	$V_{CE(sat)}$	-	0.2	V
at $I_C = 50\text{ mA}$, $I_B = 5\text{ mA}$	$V_{CE(sat)}$	-	0.3	V
Base Emitter Saturation Voltage at $I_C = 10\text{ mA}$, $I_B = 1\text{ mA}$	$V_{BE(sat)}$	-	0.85	V
at $I_C = 50\text{ mA}$, $I_B = 5\text{ mA}$	$V_{BE(sat)}$	-	0.95	V
Gain Bandwidth Product at $V_{CE} = 20\text{ V}$, $I_C = 10\text{ mA}$, $f = 100\text{ MHz}$	f_T	300	-	MHz
Collector Base Capacitance at $V_{CB} = 5\text{ V}$, $f = 100\text{ KHz}$	C_{ob}	-	4	pF
Delay Time at $V_{CC} = 3\text{ V}$, $V_{BE} = 0.5\text{ V}$, $I_C = 10\text{ mA}$, $I_{B1} = 1\text{ mA}$	t_d	-	35	ns
Rise Time at $V_{CC} = 3\text{ V}$, $V_{BE} = 0.5\text{ V}$, $I_C = 10\text{ mA}$, $I_{B1} = 1\text{ mA}$	t_r	-	35	ns
Storage Time at $V_{CC} = 3\text{ V}$, $I_C = 10\text{ mA}$, $I_{B1} = -I_{B2} = 1\text{ mA}$	t_s	-	200	ns
Fall Time at $V_{CC} = 3\text{ V}$, $I_C = 10\text{ mA}$, $I_{B1} = -I_{B2} = 1\text{ mA}$	t_f	-	50	ns

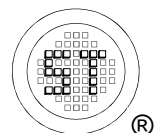

Electrical Characteristics Curves

Fig. 1 Output Characteristics Curve

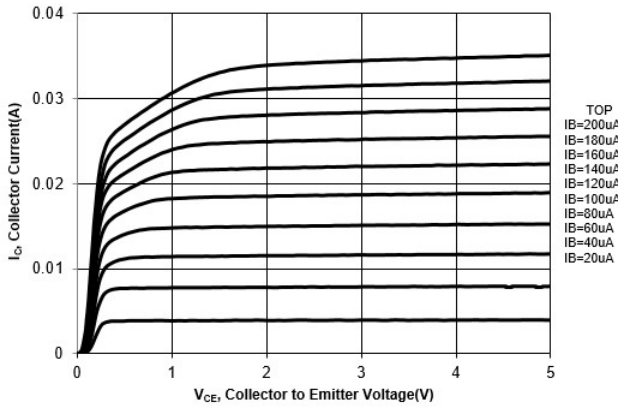

Fig. 2 Output Characteristics Curve

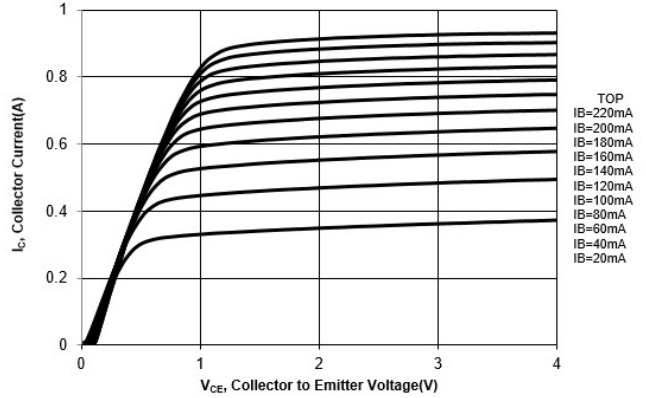

Fig. 3 Collector Current vs. V_{BE}

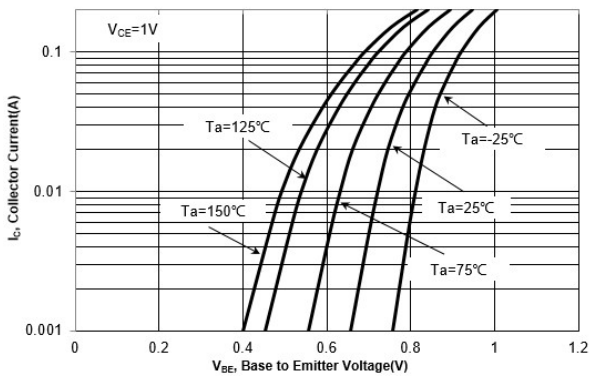
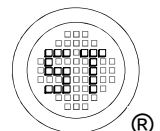
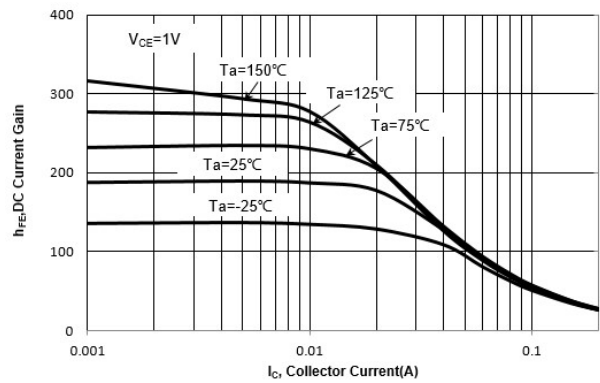

Fig. 4 h_{FE} vs. Collector Current



Electrical Characteristics Curves

Fig. 5 $V_{BE(sat)}$ vs. Collector Current

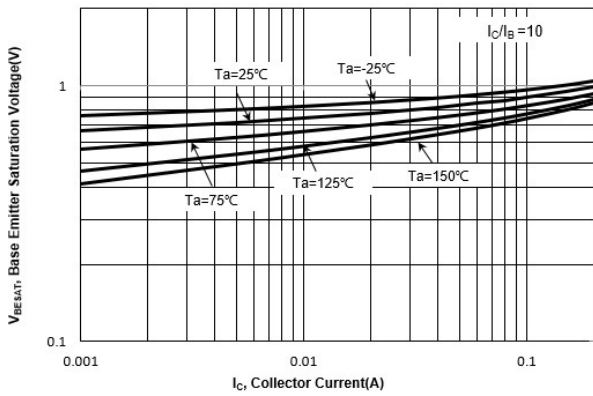

Fig. 6 $V_{CE(sat)}$ vs. Collector Current

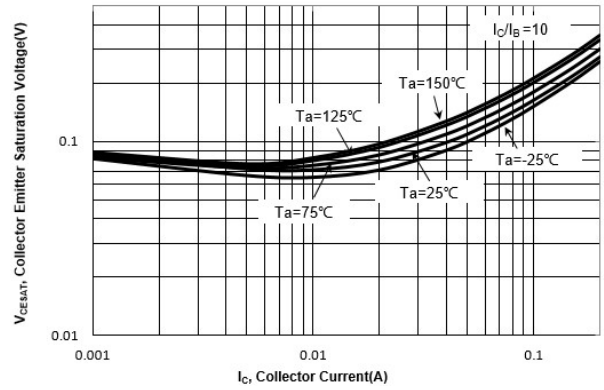

Fig. 7. Output Capacitance

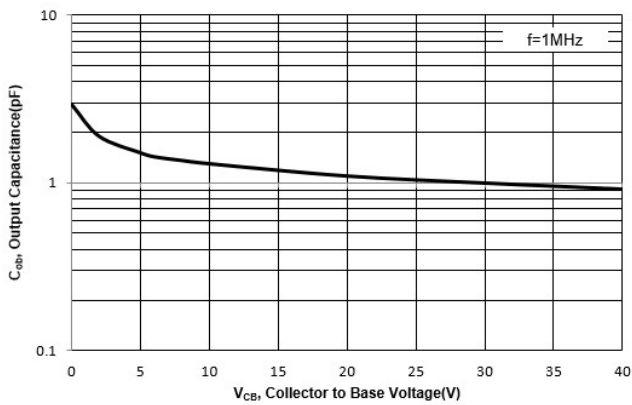
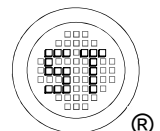
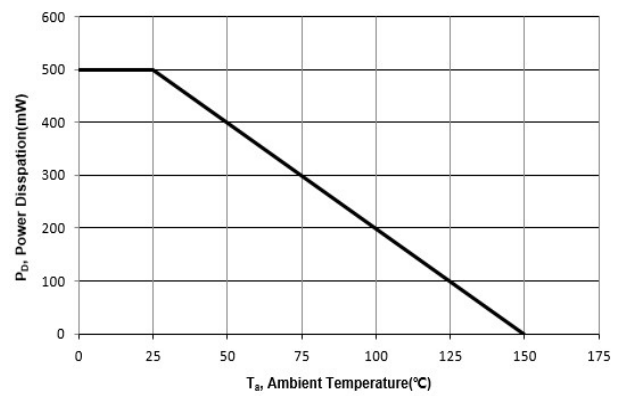

Fig. 8 Power Derating Curve



2N3904U

Package Outline (Dimensions in mm)

SOT-89

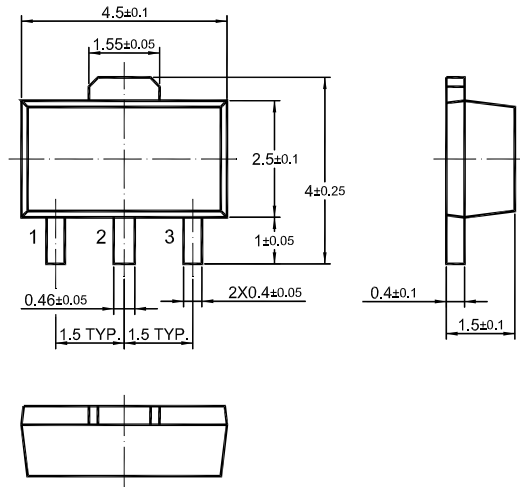

Recommended Soldering Footprint

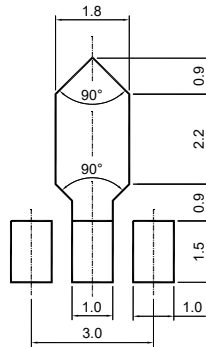

Packing information

Package	Tape Width (mm)	Pitch		Reel Size		Per Reel Packing Quantity
		mm	inch	mm	inch	
SOT-89	12	8 ± 0.1	0.315 ± 0.004	178	7	1,000
				330	13	4,000

Marking information

"2N3904U" = Part No.
 "YM" = Date Code Marking
 "Y" = Year
 "M" = Month
 Font type: Arial

