



CTH214 Series

AC Input 4-Pin Half Pitch Mini-Flat Phototransistor Optocoupler

Features

- High isolation 3750 VRMS
- CTR flexibility available see order information
- DC input with transistor output
- Operating Temperature range - 55 °C to 110 °C
- Regulatory Approvals
 - UL - UL1577 (E364000)
 - VDE - EN60747-5-5(VDE0884-5)
 - CQC – GB4943.1, GB8898
 - IEC60065, IEC60950
- Green Package

Description

The CTH214 series consists of a phototransistor optically coupled to two gallium arsenide Infrared-emitting diode, connected in inverse parallel in a 4-lead half pitch Mini-Flat package.

Applications

- Switch mode power supplies
- Computer peripheral interface
- Microprocessor system interface

Package Outline

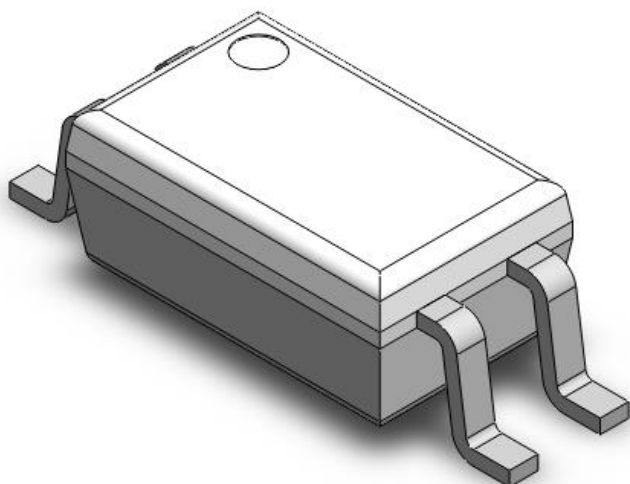

Schematic

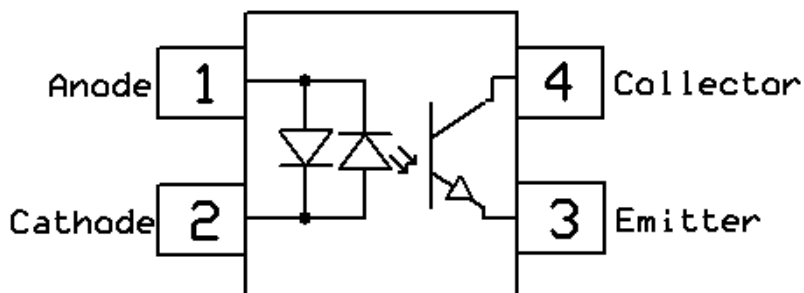



CTH214 Series

AC Input 4-Pin Half Pitch Mini-Flat Phototransistor Optocoupler

Absolute Maximum Rating at 25°C

Symbol	Parameters	Ratings	Units	Notes
V _{ISO}	Isolation voltage	3750	V _{RMS}	
P _{TOT}	Total power dissipation	200	mW	
T _{OPR}	Operating temperature	-55 ~ +110	°C	
T _{STG}	Storage temperature	-55 ~ +150	°C	
T _{SOL}	Soldering temperature	260	°C	
Emitter				
I _F	Forward current	±50	mA	
I _{F(TRANS)}	Peak transient current (≤1μs P.W,300pps)	1	A	
P _D	Emitter power dissipation	70	mW	
Detector				
P _D	Detector power dissipation	150	mW	
B _{VCEO}	Collector-Emitter Breakdown Voltage	80	V	
B _{VECO}	Emitter-Collector Breakdown Voltage	6	V	
I _C	Collector Current	50	mA	



CTH214 Series

AC Input 4-Pin Half Pitch Mini-Flat Phototransistor Optocoupler

Electrical Characteristics $T_A = 25^\circ\text{C}$ (unless otherwise specified)

Emitter Characteristics

Symbol	Parameters	Test Conditions	Min	Typ	Max	Units	Notes
V_F	Forward voltage	$I_F = \pm 10\text{mA}$		1.24	1.4	V	
C_{IN}	Input Capacitance	$f = 1\text{MHz}$	-	30	-	pF	

Detector Characteristics

Symbol	Parameters	Test Conditions	Min	Typ	Max	Units	Notes
$B_{V_{CEO}}$	Collector-Emitter Breakdown	$I_C = 100\mu\text{A}$	80	-	-	V	
$B_{V_{ECO}}$	Emitter-Collector Breakdown	$I_E = 100\mu\text{A}$	6	-	-	V	
I_{CEO}	Collector-Emitter Dark Current	$V_{CE} = 20\text{V}, I_F = 0\text{mA}$	-	-	100	nA	

Transfer Characteristics

Symbol	Parameters	Test Conditions	Min	Typ	Max	Units	Notes
CTR	Current Transfer Ratio	CTH214	$I_F = \pm 1\text{mA}, V_{CE} = 5\text{V}$	20	-	300	%
		CTH214A		50	-	150	
CTR	Current Transfer Ratio	CTH214	$I_F = \pm 5\text{mA}, V_{CE} = 5\text{V}$	30	-	600	%
		CTH214A		80	-	300	
	CTR Symmetry	$I_F = \pm 1\text{mA}, V_{CE} = 5\text{V}$	0.7	-	1.3		
$V_{CE(SAT)}$	Collector-Emitter Saturation Voltage	$I_F = \pm 20\text{mA}, I_C = 1\text{mA}$	-	0.04	0.2	V	
R_{IO}	Isolation Resistance	$V_{IO} = 500\text{V}_{DC}$	5×10^{10}	-	-	Ω	
C_{IO}	Isolation Capacitance	$f = 1\text{MHz}$	-	0.5	1	pF	

Switching Characteristics

Symbol	Parameters	Test Conditions	Min	Typ	Max	Units	Notes
t_r	Rise Time	$I_C = 2\text{mA}, V_{CE} = 2\text{V}, R_L = 100\Omega$	-	6	-	μs	
t_f	Fall Time		-	8	-		



CTH214 Series AC Input 4-Pin Half Pitch Mini-Flat Phototransistor Optocoupler

Typical Characteristic Curves

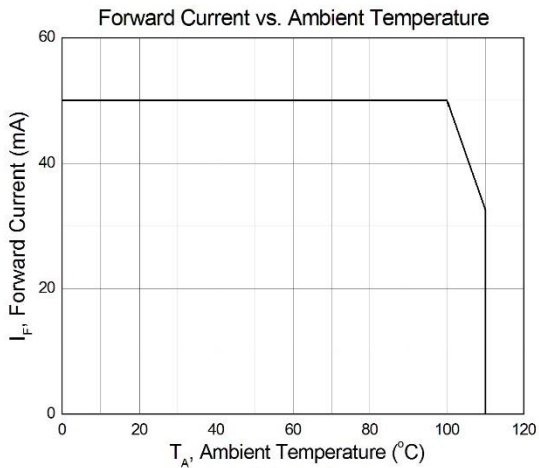

Figure 1

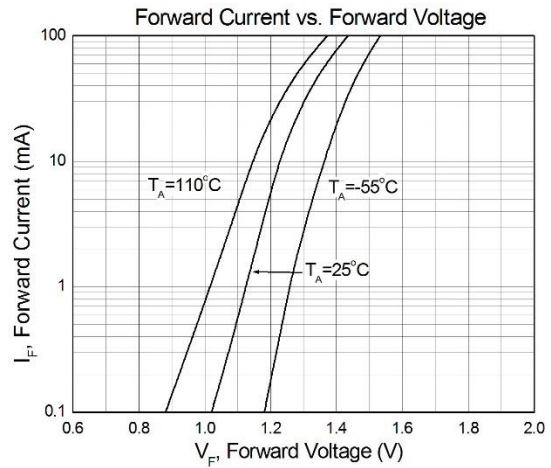

Figure 2

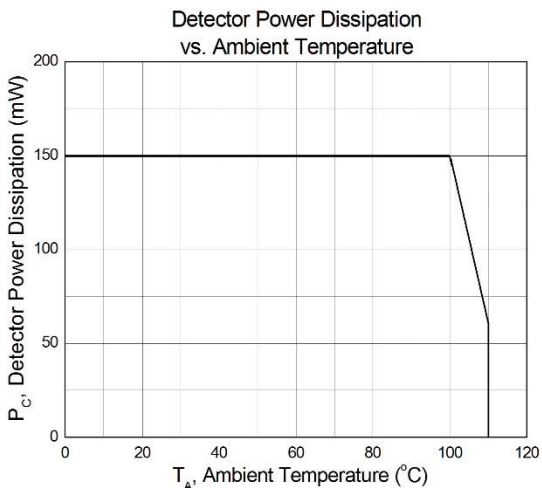

Figure 3

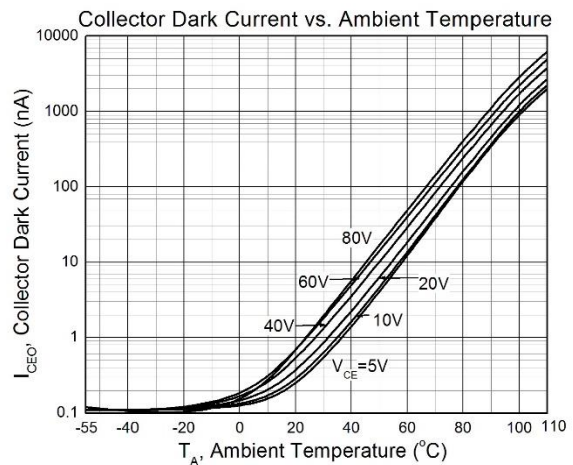

Figure 4

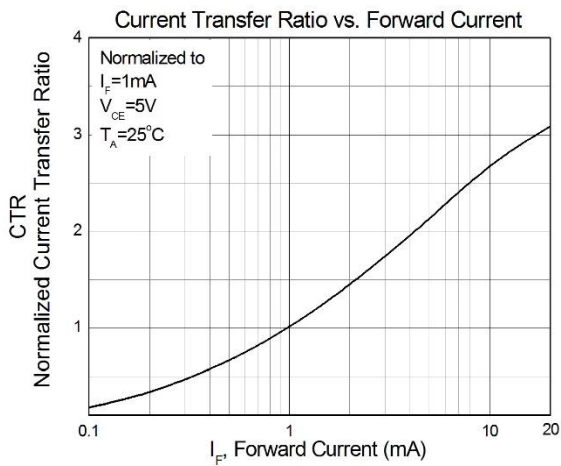

Figure 5

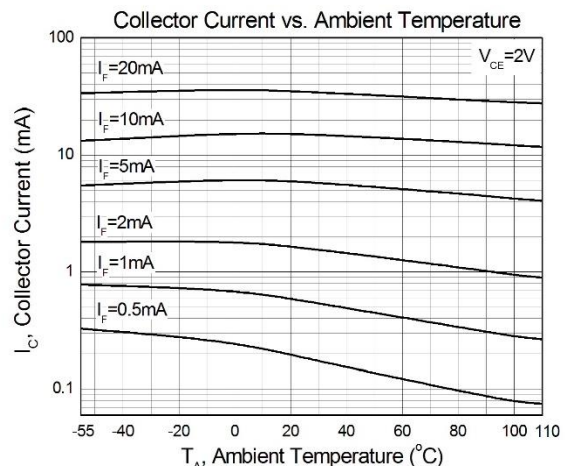

Figure 6



CTH214 Series AC Input 4-Pin Half Pitch Mini-Flat Phototransistor Optocoupler

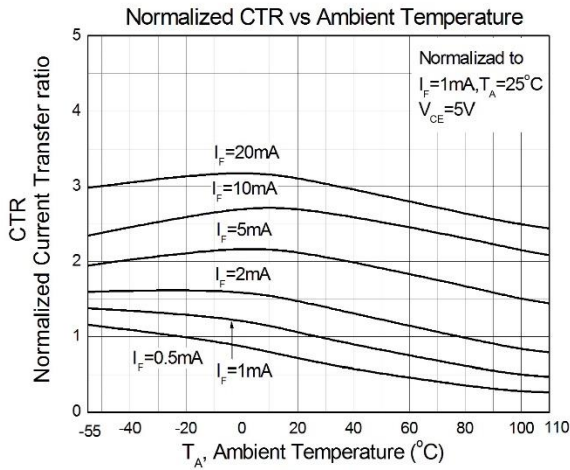

Figure 7

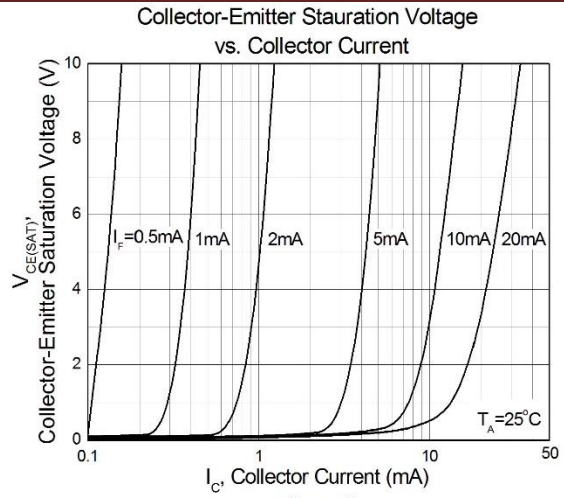

Figure 8

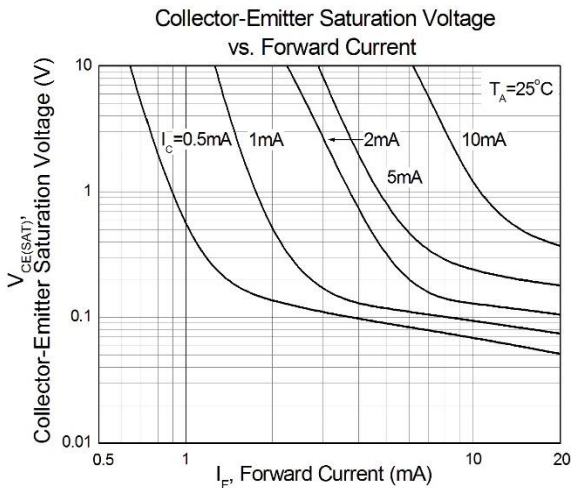

Figure 9

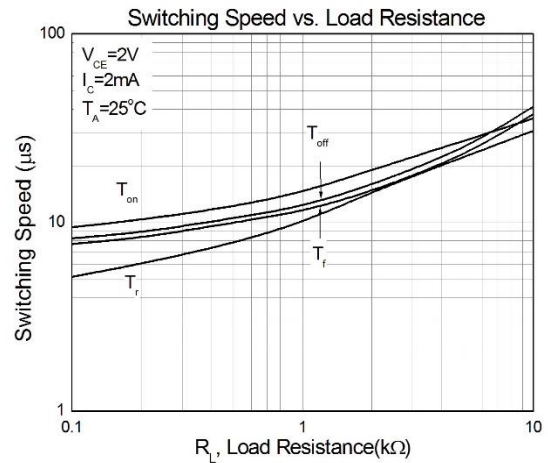

Figure 10

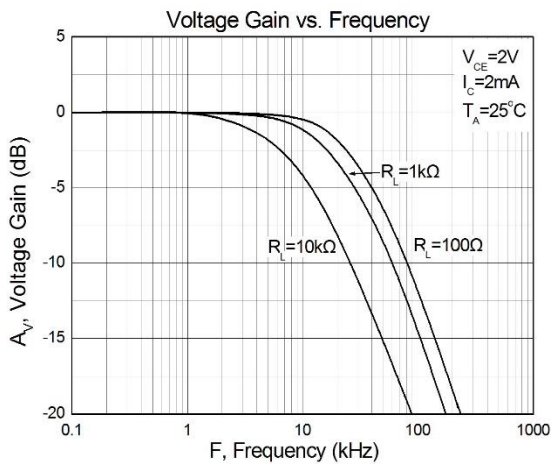

Figure 11

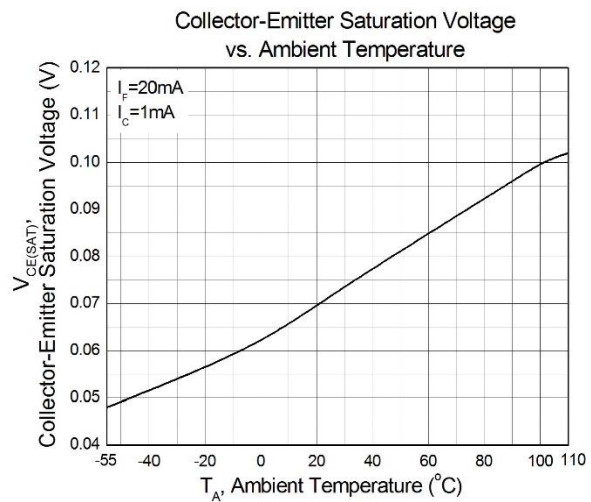

Figure 12



CTH214 Series

AC Input 4-Pin Half Pitch Mini-Flat

Phototransistor Optocoupler

Package Dimension *Dimensions in mm unless otherwise stated*

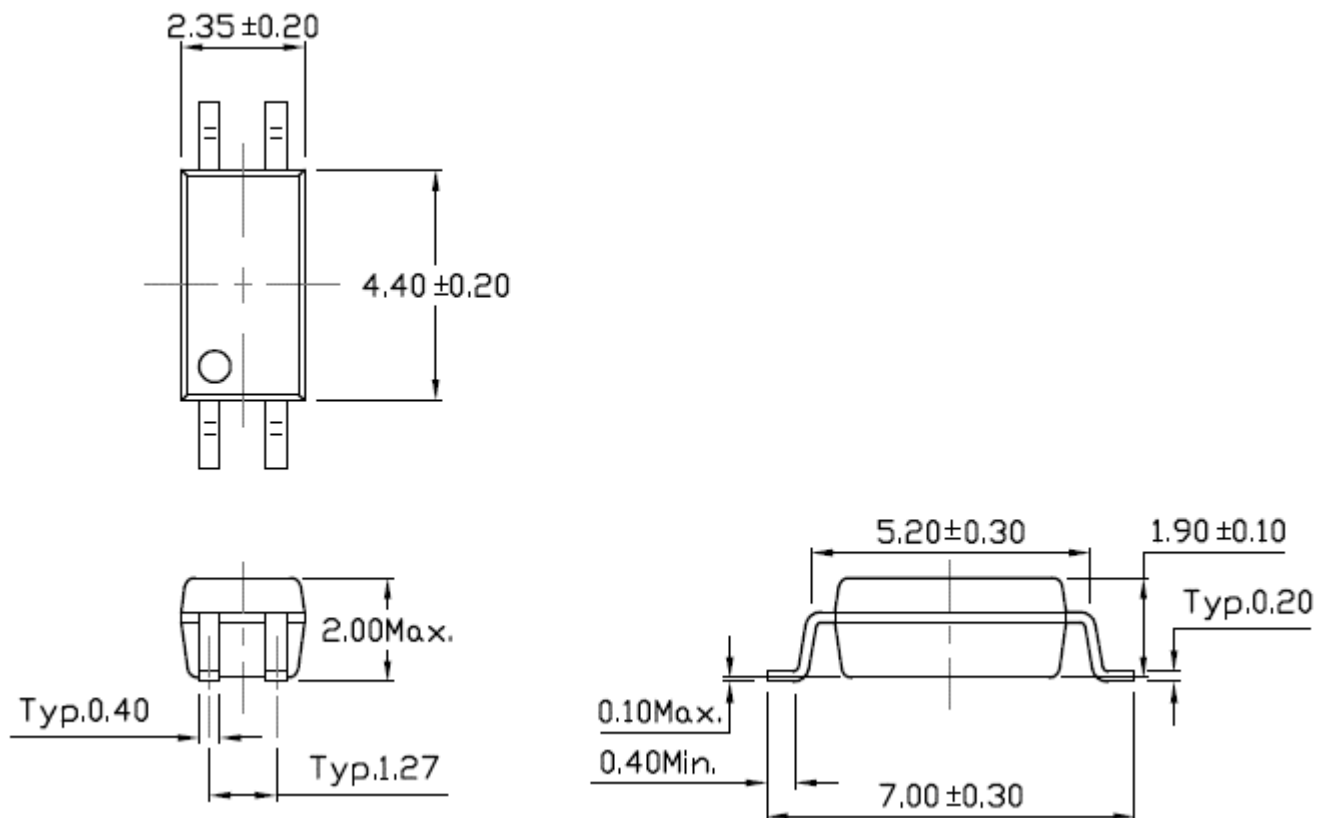

Recommended Solder Mask *Dimensions in mm unless otherwise stated*

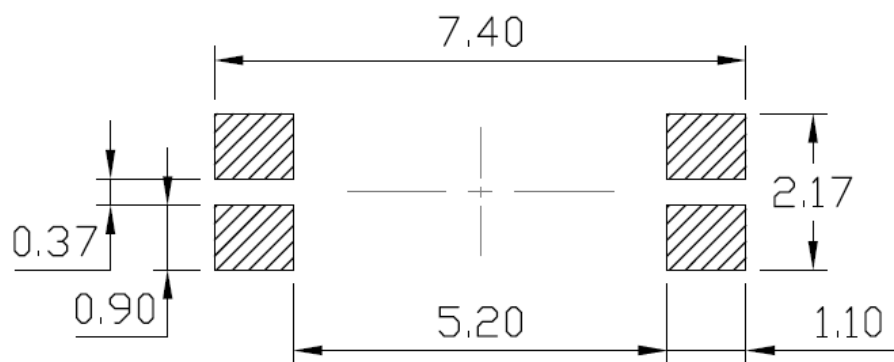



CTH214 Series

AC Input 4-Pin Half Pitch Mini-Flat Phototransistor Optocoupler

Marking Information

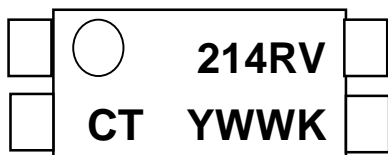

Note:

- CT : Denotes "CT Micro"
- 214 : Product Number
- R : CTR Rank
- V : VDE Option
- Y : Fiscal Year
- WW : Work Week
- K : Manufacturing Code

Ordering Information

CTH214X(V)(Z)

X = Part No. (X=A or none)

V = VDE Option (V or none)

Z = Tape and reel option (T1 or T2)

Option	Description	Quantity
T1	Surface Mount Lead Forming – With Option 1 Taping	5000 Units/Reel
T2	Surface Mount Lead Forming – With Option 2 Taping	5000 Units/Reel



CTH214 Series AC Input 4-Pin Half Pitch Mini-Flat Phototransistor Optocoupler

Carrier Tape Specifications *Dimensions in mm unless otherwise stated*

Option T1

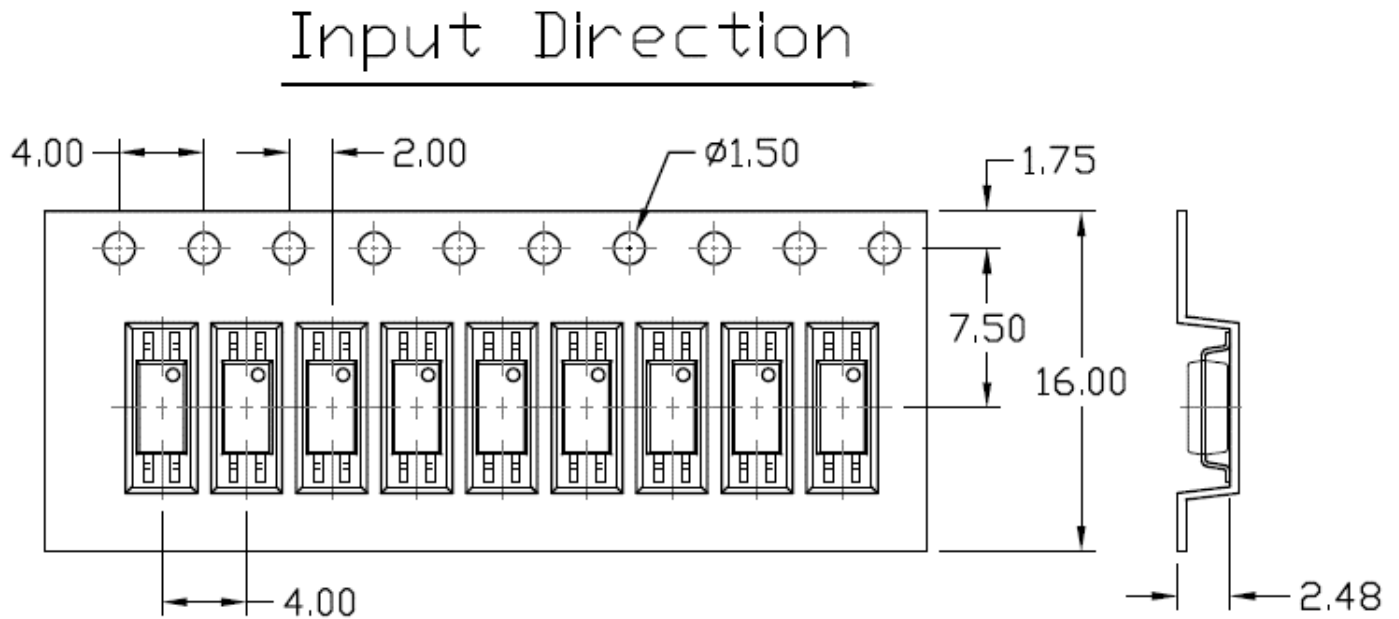

Option T2

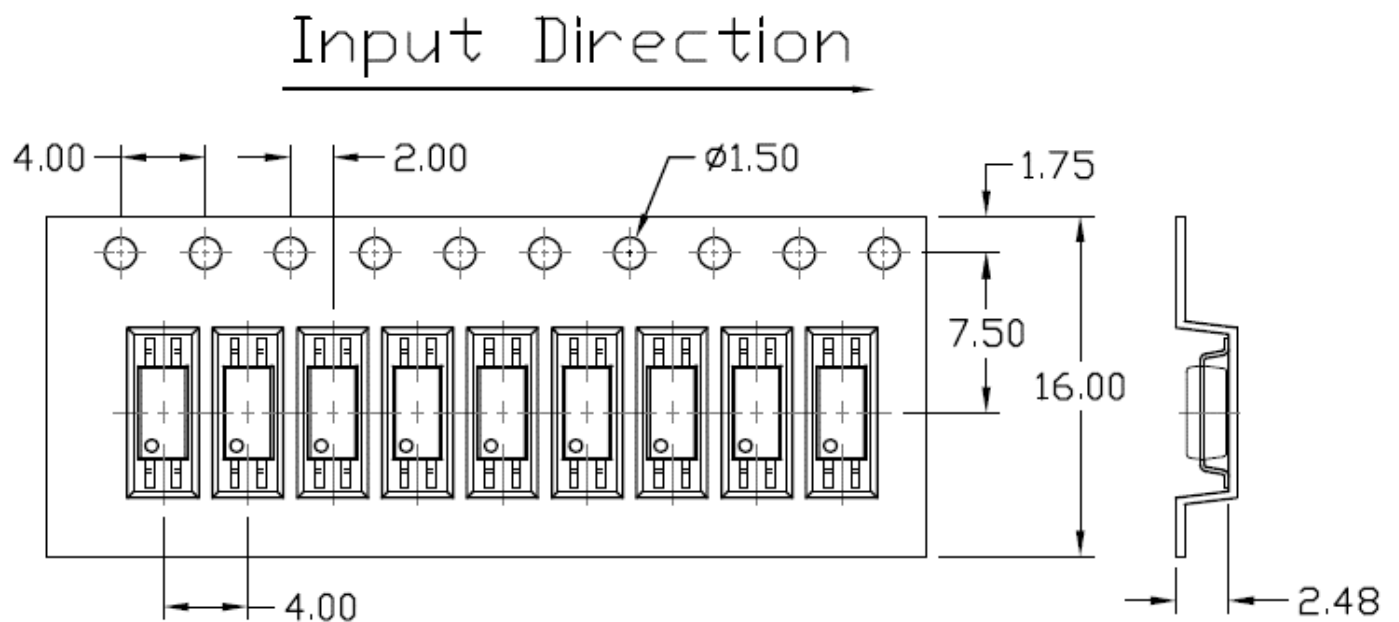



CTH214 Series

AC Input 4-Pin Half Pitch Mini-Flat Phototransistor Optocoupler

Reflow Profile

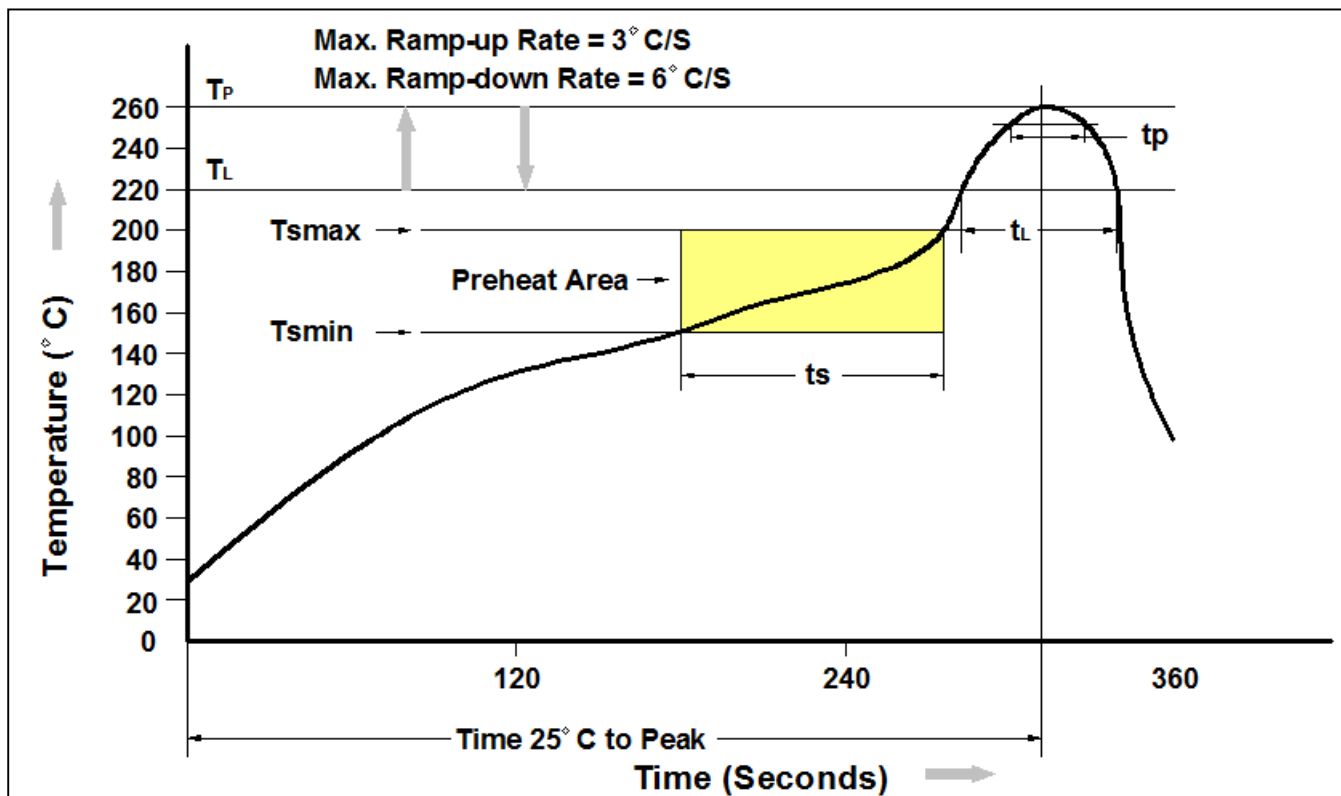

Profile Feature	Pb-Free Assembly Profile
Temperature Min. (T _{smin})	150°C
Temperature Max. (T _{smax})	200°C
Time (t _s) from (T _{smin} to T _{smax})	60-120 seconds
Ramp-up Rate (t _L to t _P)	3°C/second max.
Liquidous Temperature (T _L)	217°C
Time (t _L) Maintained Above (T _L)	60 – 150 seconds
Peak Body Package Temperature	260°C +0°C / -5°C
Time (t _P) within 5°C of 260°C	30 seconds
Ramp-down Rate (T _P to T _L)	6°C/second max
Time 25°C to Peak Temperature	8 minutes max.



CTH214 Series AC Input 4-Pin Half Pitch Mini-Flat Phototransistor Optocoupler

DISCLAIMER

CT MICRO RESERVES THE RIGHT TO MAKE CHANGES WITHOUT FURTHER NOTICE TO ANY PRODUCTS HEREIN TO IMPROVE RELIABILITY, FUNCTION OR DESIGN. CT MICRO DOES NOT ASSUME ANY LIABILITY ARISING OUT OF THE APPLICATION OR USE OF ANY PRODUCT OR CIRCUIT DESCRIBED HEREIN; NEITHER DOES IT CONVEY ANY LICENSE UNDER ITS PATENT RIGHTS, NOR THE RIGHTS OF OTHERS.

DISCOLORATION MIGHT OCCUR ON THE PACKAGE SURFACE AFTER SOLDERING, REFLOW OR LONG TERM USE. THIS DOES NOT IMPACT THE PRODUCT PERFORMANCE NOR THE PRODUCT RELIABILITY.

CT MICRO ARE NOT AUTHORIZED FOR USE AS CRITICAL COMPONENTS IN LIFE SUPPORT DEVICES OR SYSTEMS WITHOUT EXPRESS WRITTEN APPROVAL OF CT MICRO INTERNATIONAL CORPORATION.

- 1. Life support devices or systems are devices or systems which, (a) are intended for surgical implant into the body, or (b) support or sustain life, or (c) whose failure to perform when properly used in accordance with instruction for use provided in the labelling, can be reasonably expected to result in significant injury to the user.*
- 2. A critical component is any component of a life support device or system whose failure to perform can be reasonably expected to cause the failure of the life support device or system, or to affect its safety or effectiveness.*