

# UDZ2.4B-FL THRU UDZ36B-FL

## List

List..... 1

Package outline..... 2

Features..... 2

Mechanical data..... 2

Maximum ratings ..... 2

Electrical characteristics..... 3

Rating and characteristic curves..... 4

Pinning information..... 5

Suggested solder pad layout..... 5

Packing information..... 6

Reel packing..... 7

Suggested thermal profiles for soldering processes..... 7

High reliability test capabilities..... 8

# UDZ2.4B-FL THRU UDZ36B-FL

200mW Surface Mount Zener  
Diodes 2.4V-36V

## Features

- Zener voltage range selection, 2.4V to 36V
- Flat lead SOD-323FL small outline plastic package
- Surface device type mounting
- Lead-free parts meet RoHS requirements
- Suffix "-H" indicates Halogen-free part, ex.UDZ2.4B-FL-H

## Mechanical data

- Epoxy : UL94-V0 rated flame retardant
- Case : Molded plastic, SOD-323FL
- Terminals :Plated terminals, solderable per MIL-STD-750, Method 2026
- Polarity : Indicated by cathode band
- Mounting Position : Any
- Weight : Approximated 0.004 gram

## Package outline

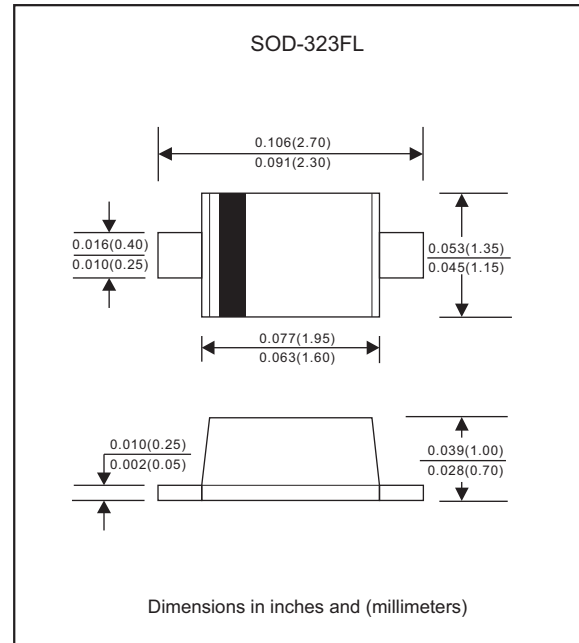

## Maximum ratings (at $T_A=25^\circ\text{C}$ unless otherwise noted)

Parameter	Conditions	Symbol	MIN.	TYP.	MAX.	Unit
Power dissipation	$T_A=25^\circ\text{C}$	$P_D$			200	mW
Forward voltage	$I_F=10\text{mA}$	$V_F$			1.0	V
Operating junction temperature range		$T_J$	-65		+150	$^\circ\text{C}$
Storage temperature range		$T_{STG}$	-65		+150	$^\circ\text{C}$

These ratings are limiting values above which the serviceability of the diode may be impaired.

## UDZ2.4B-FL THRU UDZ36B-FL

Electrical characteristics (at  $T_A=25^\circ\text{C}$  unless otherwise noted)

Part No.	Marking code	Zener voltage		Test current	Zener impedance			Leakage current	
		$V_Z @ I_{ZT}$			$Z_{ZT} @ I_{ZT}$	$Z_{ZK} @ I_{ZK}$	$I_{ZK}$	$I_R$	$V_R$
		Min(V)	Max(V)	mA	Max( $\Omega$ )	Max( $\Omega$ )	mA	Max( $\mu\text{A}$ )	Volts
UDZ2.4B-FL	D=,DT	2.43	2.63	5	100	1000	0.5	120	1.0
UDZ2.7B-FL	DΞ,DU	2.69	2.91	5	110	1000	0.5	100	1.0
UDZ3.0B-FL	D>,DV	3.01	3.22	5	120	1000	0.5	50	1.0
UDZ3.3B-FL	D<,DW	3.32	3.53	5	120	1000	0.5	20	1.0
UDZ3.6B-FL	D0	3.60	3.85	5	90	600	1.0	4.5	1.0
UDZ3.9B-FL	D1	3.89	4.16	5	90	600	1.0	2.7	1.0
UDZ4.3B-FL	D2	4.17	4.43	5	90	600	1.0	2.7	1.0
UDZ4.7B-FL	D3	4.55	4.75	5	80	500	1.0	2.7	2.0
UDZ5.1B-FL	D4	4.98	5.20	5	60	500	1.0	1.8	2.0
UDZ5.6B-FL	D5	5.49	5.73	5	40	300	1.0	0.9	2.0
UDZ6.2B-FL	D6	6.06	6.33	5	40	150	1.0	2.7	4.0
UDZ6.8B-FL	D7	6.65	6.93	5	30	75	1.0	1.8	4.0
UDZ7.5B-FL	D8	7.28	7.60	5	30	75	1.0	0.9	5.0
UDZ8.2B-FL	D9	8.02	8.36	5	30	75	1.0	0.63	5.0
UDZ9.1B-FL	DA	8.85	9.23	5	30	90	1.0	0.45	6.0
UDZ10B-FL	DB	9.77	10.21	5	20	150	1.0	0.18	7.0
UDZ11B-FL	DC	10.76	11.22	5	20	150	1.0	0.09	8.0
UDZ12B-FL	DE	11.74	12.24	5	20	150	1.0	0.09	8.0
UDZ13B-FL	DF	12.91	13.49	5	40	160	1.0	0.09	8.0
UDZ15B-FL	DG	14.34	14.98	5	40	190	1.0	0.045	10.5
UDZ16B-FL	DH	15.85	16.51	5	40	190	1.0	0.045	11.2
UDZ18B-FL	DJ	17.56	18.35	5	50	220	1.0	0.045	12.6
UDZ20B-FL	DK	19.52	20.39	5	60	220	1.0	0.045	14.0
UDZ22B-FL	DL	21.54	22.47	5	80	240	1.0	0.045	15.4
UDZ24B-FL	DM	23.72	24.78	5	80	240	1.0	0.045	16.8
UDZ27B-FL	DN	26.19	27.53	5	100	300	0.5	0.045	18.9
UDZ30B-FL	DP	29.19	30.69	5	100	300	0.5	0.045	21.0
UDZ33B-FL	DR	32.15	33.79	5	100	310	0.5	0.045	23.0
UDZ36B-FL	DS	35.07	36.87	5	100	330	0.5	0.045	25.2

Notes: 1: The zener voltage ( $V_Z$ ) is tested under pulse condition of 10ms.

2: The zener impedance is derived from the 60-cycle ac voltage, which results when an ac current having an rms value equal to 10% of the dc zener current ( $I_{ZT}$  or  $I_{ZK}$ ) is superimposed to  $I_{ZT}$  or  $I_{ZK}$ .

## Rating and characteristic curves (UDZ2.4B-FL THRU UDZ36B-FL)

FIG.1-ZENER VOLTAGE CHARACTERISTICS

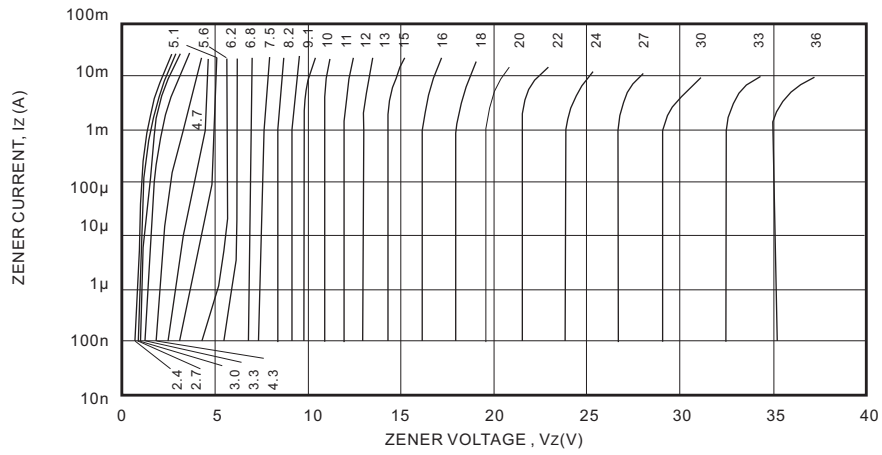
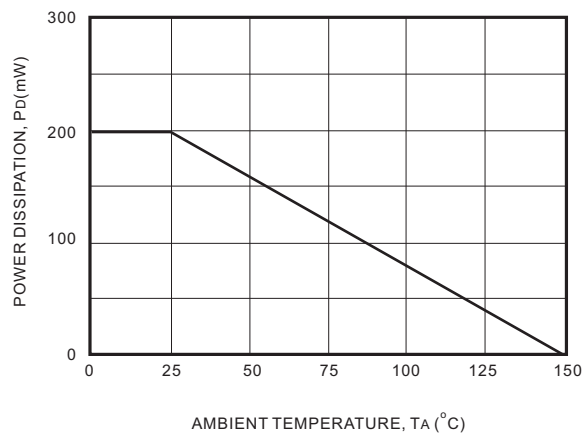



FIG. 2-DRATING CURVE



# UDZ2.4B-FL THRU UDZ36B-FL

## Pinning information

Pin	Simplified outline	Symbol
Pin1 cathode Pin2 anode		

## Suggested solder pad layout

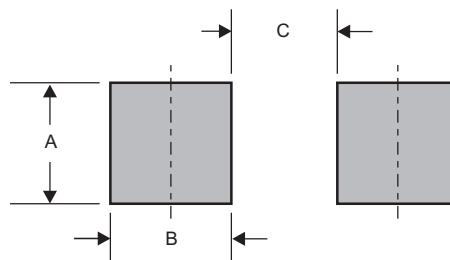

Dimensions in inches and (millimeters)

PACKAGE	A	B	C
SOD-323FL	0.032 (0.82)	0.022 (0.56)	0.069 (1.75)

# UDZ2.4B-FL THRU UDZ36B-FL

## Packing information

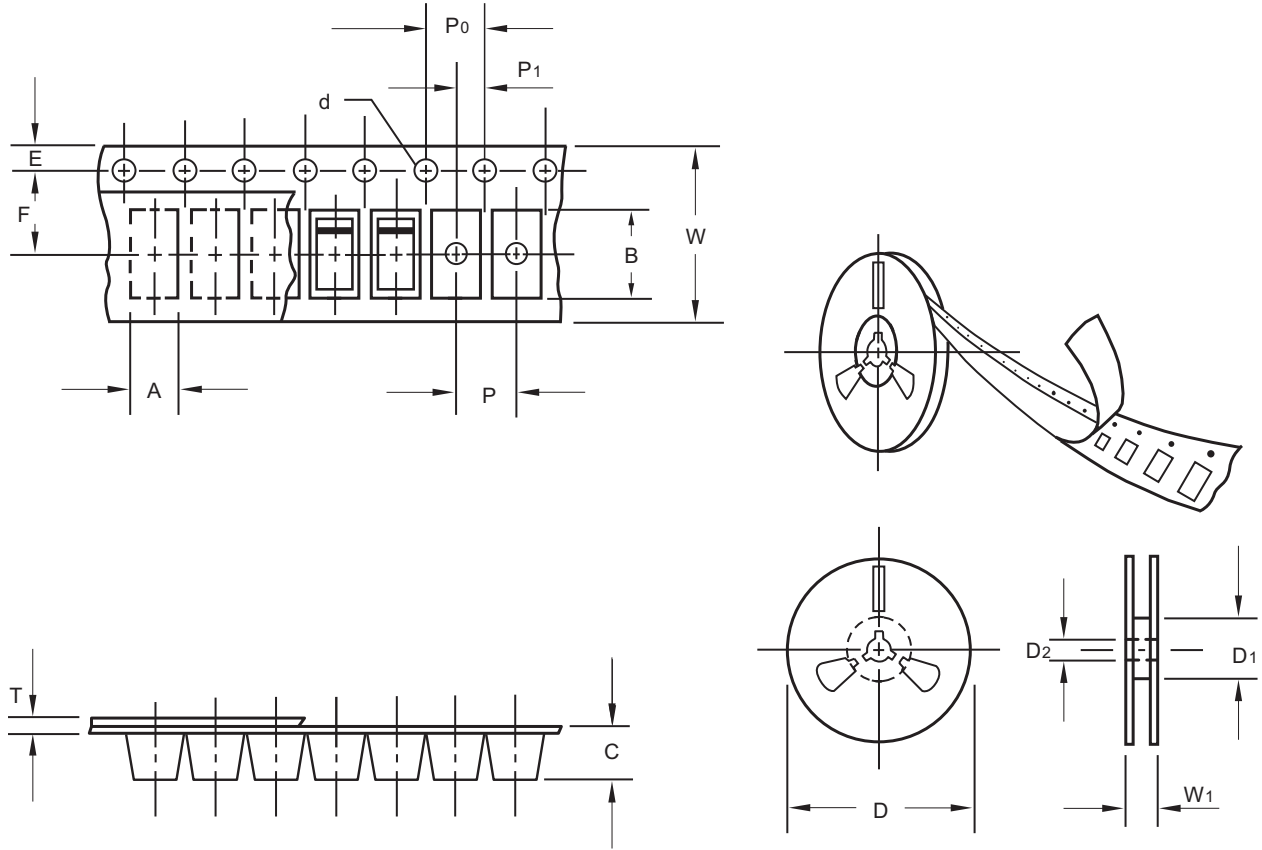

unit:mm

Item	Symbol	Tolerance	SOD-323FL
Carrier width	A	0.1	1.46
Carrier length	B	0.1	2.95
Carrier depth	C	0.1	1.25
Sprocket hole	d	0.1	1.50
13" Reel outside diameter	D	2.0	-
13" Reel inner diameter	D1	min	-
7" Reel outside diameter	D	2.0	178.00
7" Reel inner diameter	D1	min	62.00
Feed hole diameter	D2	0.5	13.00
Sprocket hole position	E	0.1	1.75
Punch hole position	F	0.1	3.50
Punch hole pitch	P	0.1	4.00
Sprocket hole pitch	P0	0.1	4.00
Embossment center	P1	0.1	2.00
Overall tape thickness	T	0.1	0.23
Tape width	W	0.3	8.00
Reel width	W1	1.0	11.40

Note: Devices are packed in accordance with EIA standard RS-481-A and specifications listed above.

# UDZ2.4B-FL THRU UDZ36B-FL

## Reel packing

PACKAGE	REEL SIZE	REEL (pcs)	COMPONENT SPACING (m/m)	BOX (pcs)	INNER BOX (m/m)	REEL DIA, (m/m)	CARTON SIZE (m/m)	CARTON (pcs)	APPROX. GROSS WEIGHT (kg)
SOD-323FL	7"	3,000	4.0	30,000	183*123*183	178	382*257*387	240,000	9.5

## Suggested thermal profiles for soldering processes

- 1.Storage environment: Temperature=5°C~40°C Humidity=55%±25%
- 2.Reflow soldering of surface-mount devices

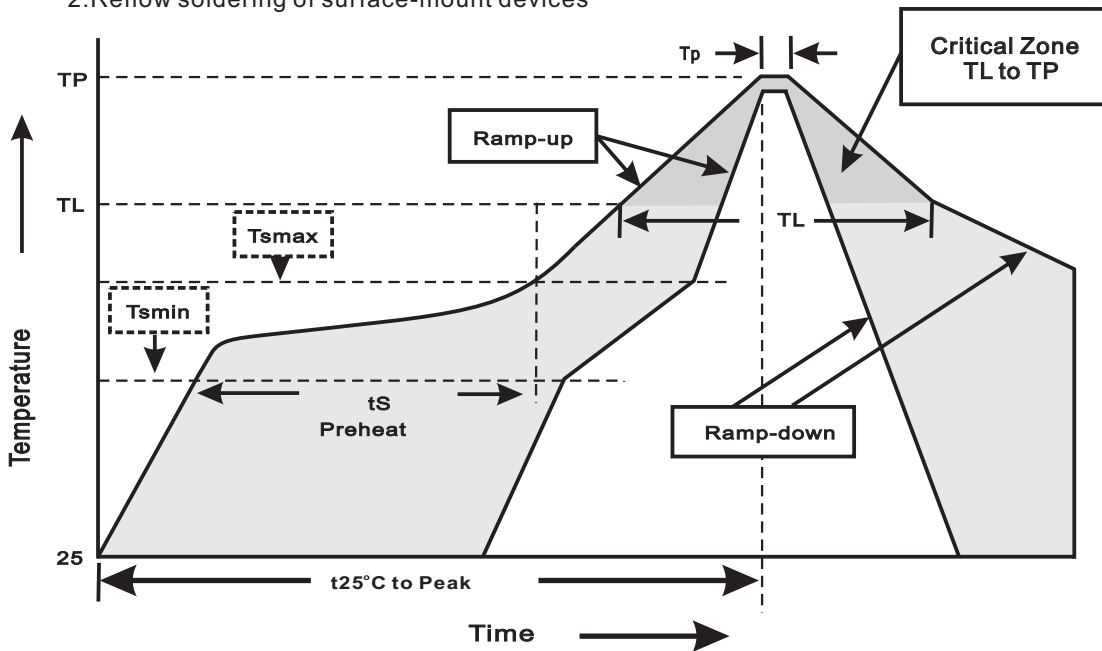

### 3.Reflow soldering

Profile Feature	Soldering Condition
Average ramp-up rate(T <sub>L</sub> to T <sub>P</sub> )	<3°C/sec
Preheat -Temperature Min(T <sub>smín</sub> ) -Temperature Max(T <sub>smáx</sub> ) -Time(min to max)(t <sub>s</sub> )	150°C 200°C 60~120sec
T <sub>smáx</sub> to T <sub>L</sub> -Ramp-upRate	<3°C/sec
Time maintained above: -Temperature(T <sub>L</sub> ) -Time(t <sub>L</sub> )	217°C 60~260sec
Peak Temperature(T <sub>P</sub> )	255°C-0/+5°C
Time within 5°C of actual Peak Temperature(t <sub>P</sub> )	10~30sec
Ramp-down Rate	<6°C/sec
Time 25°C to Peak Temperature	<6minutes

**UDZ2.4B-FL THRU UDZ36B-FL****High reliability test capabilities**

Item Test	Conditions	Reference
1. Solder Resistance	at 260±5°C for 10±2sec.	MIL-STD-750D METHOD-2031
2. Solderability	at 245±5°C for 5 sec.	MIL-STD-202F METHOD-208
3. High Temperature Reverse Bias	$V_z = V_z \text{ Min} * 80\%$ at $T_j = 150^\circ\text{C}$ for 168 hrs.	MIL-STD-750D METHOD-1038
4. Pressure Cooker	15P <sub>SIG</sub> at $T_A = 121^\circ\text{C}$ for 4 hrs.	JESD22-A102
5. Temperature Cycling	-55°C to +125°C dwelled for 30 min. and transferred for 5min. total 10 cycles.	MIL-STD-750D METHOD-1051
6. Humidity	at $T_A = 85^\circ\text{C}$ , RH=85% for 1000hrs.	MIL-STD-750D METHOD-1021
7. High Temperature Storage Life	at 175°C for 1000 hrs.	MIL-STD-750D METHOD-1031