

Digital Transistors (Built-in Resistors)

DTD123YUA DIGITAL TRANSISTOR (NPN)

FEATURES

- Built-in bias resistors enable the configuration of an inverter circuit without connecting external input resistors(see equivalent circuit)
- The bias resistors consist of thin-film resistors with complete isolation to allow negative biasing of the input.They also have the advantage of almost completely eliminating parasitic effects
- Only the on/off conditions need to be set for operation, making device design easy

PIN CONNENCTIONS, MARKING and EQUIVALENT CIRCUIT

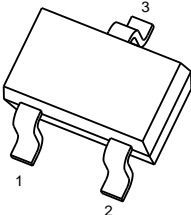
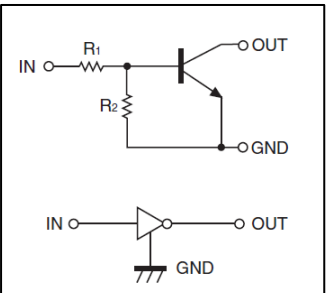
<p>DTD123YUA</p>  <p>MARKING:F62</p>	<p>SOT-323</p> <p>1. IN 2. GND 3. OUT</p>	<p>Equivalent Circuit</p> 
--	--	---

MAXIMUM RATINGS(Ta=25°C unless otherwise noted)

Symbol	Parameter	Limit	Unit
V _{CC}	Supply Voltage	50	V
V _{IN}	Input Voltage	-5~+12	V
I _O	Output Current	500	mA
P _D	Power Dissipation	200	mW
T _J	Junction Temperature	150	°C
T _{stg}	Storage Temperature	-55~+150	°C

ELECTRICAL CHARACTERISTICS (Ta=25°C unless otherwise specified)

Parameter	Symbol	Conditions	Min	Typ	Max	Unit
Input voltage	V _{I(off)}	V _{CC} =5V, I _O =100μA	0.3			V
	V _{I(on)}	V _O = 0.3V, I _O =20mA			2	V
Output voltage	V _{O(on)}	I _O /I _I =50mA/2.5mA		0.1	0.3	V
Input current	I _I	V _I =5V			3.6	mA
Output current	I _{O(off)}	V _{CC} =50V, V _I =0V			0.5	μA
DC current gain	G _I	V _O =5V, I _O =50mA	56			
Input resistance	R ₁		1.54	2.2	2.86	kΩ
Resistance ratio	R ₂ /R ₁		3.6	4.5	5.5	
Transition frequency	f _T	V _O =10V, I _O =5mA, f=100MHz		200		MHz

SOT-323 Package Outline Dimensions

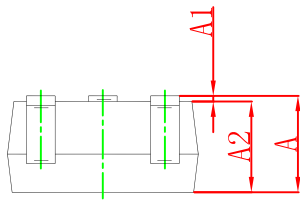
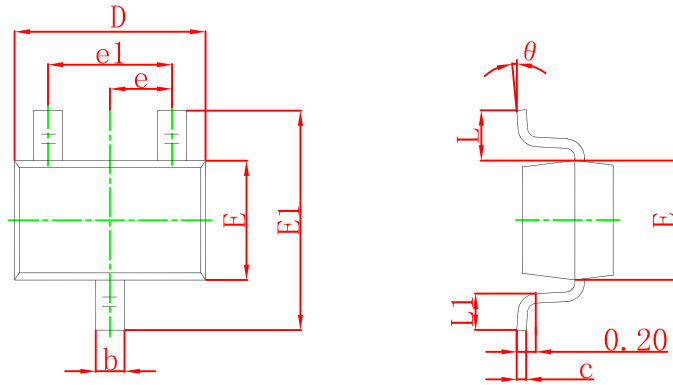

Symbol	Dimensions In Millimeters		Dimensions In Inches	
	Min	Max	Min	Max
A	0.900	1.100	0.035	0.043
A1	0.000	0.100	0.000	0.004
A2	0.900	1.000	0.035	0.039
b	0.200	0.400	0.008	0.016
c	0.080	0.150	0.003	0.006
D	2.000	2.200	0.079	0.087
E	1.150	1.350	0.045	0.053
E1	2.150	2.450	0.085	0.096
e	0.650 TYP		0.026 TYP	
e1	1.200	1.400	0.047	0.055
L	0.525 REF		0.021 REF	
L1	0.260	0.460	0.010	0.018
θ	0°	8°	0°	8°

SOT-323 Suggested Pad Layout

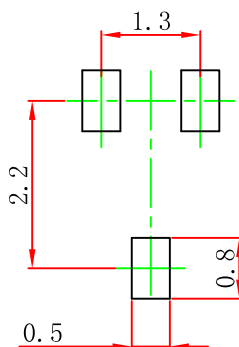

Note:

1. Controlling dimension: in millimeters.
2. General tolerance: ± 0.05 mm.
3. The pad layout is for reference purposes only.

NOTICE

JCET reserve the right to make modifications, enhancements, improvements, corrections or other changes without further notice to any product herein. JCET does not assume any liability arising out of the application or use of any product described herein.

SOT-323 Tape and Reel

SOT-323 Embossed Carrier Tape

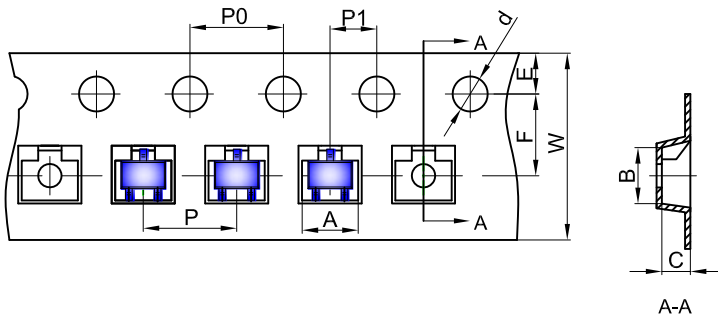

Packaging Description:

SOT-323 parts are shipped in tape. The carrier tape is made from a dissipative (carbon filled) polycarbonate resin. The cover tape is a multilayer film (Heat Activated Adhesive in nature) primarily composed of polyester film, adhesive layer, sealant, and anti-static sprayed agent. These reeled parts in standard option are shipped with 3,000 units per 7" or 17.8cm diameter reel. The reels are clear in color and is made of polystyrene plastic (anti-static coated).

Dimensions are in millimeter										
Pkg type	A	B	C	d	E	F	P0	P	P1	W
SOT-323	2.25	2.55	1.19	Ø1.55	1.75	3.50	4.00	4.00	2.00	8.00

SOT-323 Tape Leader and Trailer

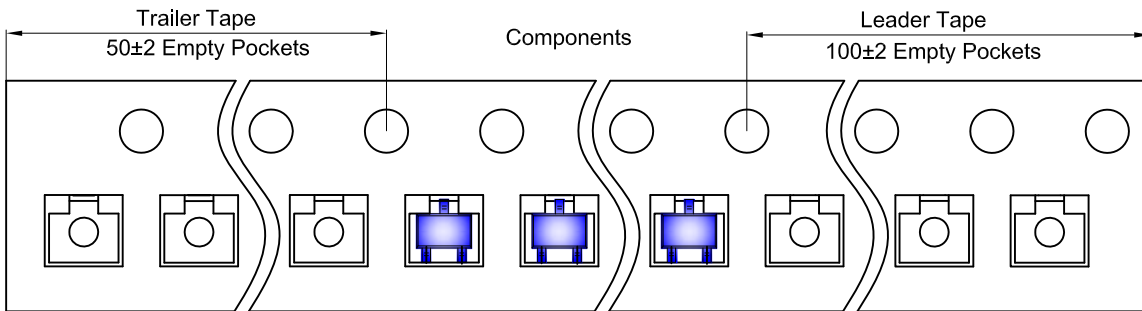

SOT-323 Reel

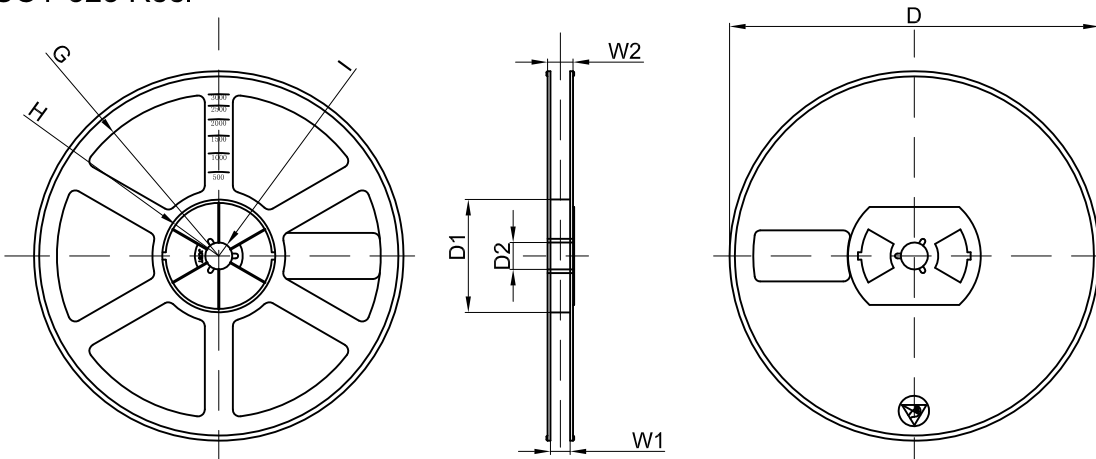

Dimensions are in millimeter								
Reel Option	D	D1	D2	G	H	I	W1	W2
7" Dia	Ø178.00	54.40	13.00	R78.00	R25.60	R6.50	9.50	12.30

REEL	Reel Size	Box	Box Size(mm)	Carton	Carton Size(mm)	G.W.(kg)
3000 pcs	7 inch	45,000 pcs	203×203×195	180,000 pcs	438×438×220	