

## Small Signal Zener Diodes, Dual

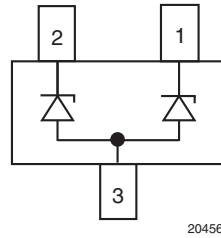
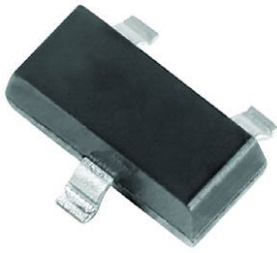

20456

**DESIGN SUPPORT TOOLS**
[click logo to get started](#)
**3D**  
Models  
Available

PRIMARY CHARACTERISTICS		
PARAMETER	VALUE	UNIT
V <sub>Z</sub> range nom.	2.7 to 51	V
Test current I <sub>ZT</sub>	5	mA
V <sub>Z</sub> specification	Pulse current	
Circuit configuration	Common anode	

**FEATURES**

- Dual silicon planar Zener diodes, common anode
- The Zener voltages are graded according to the international E24 standard. Standard Zener voltage tolerance is  $\pm 5\%$ , indicated by the "C" in the ordering code. Replace "C" with "B" for 2% tolerance
- The parameters are valid for both diodes in one case.  $\Delta V_Z$  and  $\Delta R_{zj}$  of the two diodes in one case is  $\leq 5\%$
- AEC-Q101 qualified available (part number on request)
- ESD capability according to AEC-Q101:  
human body model > 8 kV  
machine model > 800 V
- Base P/N-G3 - green, commercial grade
- Base P/N-HG3 - green, AEC-Q101 qualified (part number available on request)
- Material categorization: for definitions of compliance please see [www.vishay.com/doc?99912](http://www.vishay.com/doc?99912)

**RoHS**  
COMPLIANT  
HALOGEN  
**FREE**  
**GREEN**  
(5-2008)

ORDERING INFORMATION			
DEVICE NAME	ORDERING CODE	TAPED UNITS PER REEL	MINIMUM ORDER QUANTITY
AZ23-G-series	AZ23C2V7-G3-08 to AZ23C51-G3-08	3000 (8 mm tape on 7" reel)	15 000
	AZ23B2V7-G3-08 to AZ23B51-G3-08		
	AZ23C2V7-G3-18 to AZ23C51-G3-18	10 000 (8 mm tape on 13" reel)	10 000
	AZ23B2V7-G3-18 to AZ23B51-G3-18		

PACKAGE				
PACKAGE NAME	WEIGHT	MOLDING COMPOUND FLAMMABILITY RATING	MOISTURE SENSITIVITY LEVEL	SOLDERING CONDITIONS
SOT-23	8.1 mg	UL 94 V-0	MSL level 1 (according J-STD-020)	260 °C/10 s at terminals

ABSOLUTE MAXIMUM RATINGS (T <sub>amb</sub> = 25 °C, unless otherwise specified)				
PARAMETER	TEST CONDITION	SYMBOL	VALUE	UNIT
Power dissipation	Device on fiberglass substrate, see layout on page 6	P <sub>tot</sub>	300	mW
Thermal resistance, junction to ambient air	Device on fiberglass substrate, see layout on page 6	R <sub>thJA</sub>	420	K/W
Junction temperature		T <sub>j</sub>	150	°C
Storage temperature range		T <sub>stg</sub>	-65 to +150	°C
Zener current		I <sub>Z</sub>	P <sub>tot</sub> /V <sub>Z</sub>	mA
Operating temperature range		T <sub>op</sub>	-55 to +150	°C



<b>ELECTRICAL CHARACTERISTICS</b> ( $T_{amb} = 25\text{ }^{\circ}\text{C}$ , unless otherwise specified)												
PART NUMBER	MARKING CODE	ZENER VOLTAGE RANGE <sup>(1)</sup>			TEST CURRENT		REVERSE VOLTAGE		DYNAMIC RESISTANCE		TEMPERATURE COEFFICIENT OF ZENER VOLTAGE	
		$V_Z$ at $I_{ZT1}$			$I_{ZT1}$	$I_{ZT2}$	$V_R$ at $I_R$		$Z_Z$ at $I_{ZT1}$	$Z_{ZK}$ at $I_{ZT2}$	$\alpha_{VZ}$ at $I_{ZT}$	
		V			mA		V	nA	$\Omega$		$10^{-4}/^{\circ}\text{C}$	
		MIN.	NOM.	MAX.							MIN.	MAX.
AZ23C2V7-G	D41	2.5	2.7	2.9	5	1	-	-	75 (< 83)	< 500	-9	-4
AZ23C3V0-G	D42	2.8	3.0	3.2	5	1	-	-	80 (< 95)	< 500	-9	-3
AZ23C3V3-G	D43	3.1	3.3	3.5	5	1	-	-	80 (< 95)	< 500	-8	-3
AZ23C3V6-G	D44	3.4	3.6	3.8	5	1	-	-	80 (< 95)	< 500	-8	-3
AZ23C3V9-G	D45	3.7	3.9	4.1	5	1	-	-	80 (< 95)	< 500	-7	-3
AZ23C4V3-G	D46	4	4.3	4.6	5	1	-	-	80 (< 95)	< 500	-6	-1
AZ23C4V7-G	D47	4.4	4.7	5	5	1	-	-	70 (< 78)	< 500	-5	2
AZ23C5V1-G	D48	4.8	5.1	5.4	5	1	> 0.8	100	30 (< 60)	< 480	-3	4
AZ23C5V6-G	D49	5.2	5.6	6	5	1	> 1	100	10 (< 40)	< 400	-2	6
AZ23C6V2-G	D50	5.8	6.2	6.6	5	1	> 2	100	4.8 (< 10)	< 200	-1	7
AZ23C6V8-G	D51	6.4	6.8	7.2	5	1	> 3	100	4.5 (< 8)	< 150	2	7
AZ23C7V5-G	D52	7	7.5	7.9	5	1	> 5	100	4 (< 7)	< 50	3	7
AZ23C8V2-G	D53	7.7	8.2	8.7	5	1	> 6	100	4.5 (< 7)	< 50	4	7
AZ23C9V1-G	D54	8.5	9.1	9.6	5	1	> 7	100	4.8 (< 10)	< 50	5	8
AZ23C10-G	D55	9.4	10	10.6	5	1	> 7.5	100	5.2 (< 15)	< 70	5	8
AZ23C11-G	D56	10.4	11	11.6	5	1	> 8.5	100	6 (< 20)	< 70	5	9
AZ23C12-G	D57	11.4	12	12.7	5	1	> 9	100	7 (< 20)	< 90	6	9
AZ23C13-G	D58	12.4	13	14.1	5	1	> 10	100	9 (< 25)	< 110	7	9
AZ23C15-G	D59	13.8	15	15.6	5	1	> 11	100	11 (< 30)	< 110	7	9
AZ23C16-G	D60	15.3	16	17.1	5	1	> 12	100	13 (< 40)	< 170	8	9.5
AZ23C18-G	D61	16.8	18	19.1	5	1	> 14	100	18 (< 50)	< 170	8	9.5
AZ23C20-G	D62	18.8	20	21.2	5	1	> 15	100	20 (< 50)	< 220	8	10
AZ23C22-G	D63	20.8	22	23.3	5	1	> 17	100	25 (< 55)	< 220	8	10
AZ23C24-G	D64	22.8	24	25.6	5	1	> 18	100	28 (< 80)	< 220	8	10
AZ23C27-G	D65	25.1	27	28.9	5	1	> 20	100	30 (< 80)	< 250	8	10
AZ23C30-G	D66	28	30	32	5	1	> 22.5	100	35 (< 80)	< 250	8	10
AZ23C33-G	D67	31	33	35	5	1	> 25	100	40 (< 80)	< 250	8	10
AZ23C36-G	D68	34	36	38	5	1	> 27	100	40 (< 90)	< 250	8	10
AZ23C39-G	D69	37	39	41	5	1	> 29	100	50 (< 90)	< 300	10	12
AZ23C43-G	D70	40	43	46	5	1	> 32	100	60 (< 100)	< 700	10	12
AZ23C47-G	D71	44	47	50	5	1	> 35	100	70 (< 100)	< 750	10	12
AZ23C51-G	D72	48	51	50	5	1	> 38	100	70 (< 100)	< 750	10	12

**Note**

<sup>(1)</sup> Tested with pulses  $t_p = 5\text{ ms}$



<b>ELECTRICAL CHARACTERISTICS</b> ( $T_{amb} = 25\text{ }^{\circ}\text{C}$ , unless otherwise specified)												
PART NUMBER	MARKING CODE	ZENER VOLTAGE RANGE <sup>(1)</sup>			TEST CURRENT		REVERSE VOLTAGE		DYNAMIC RESISTANCE		TEMPERATURE COEFFICIENT OF ZENER VOLTAGE	
		$V_Z$ at $I_{ZT1}$			$I_{ZT1}$	$I_{ZT2}$	$V_R$ at $I_R$		$Z_Z$ at $I_{ZT1}$	$Z_{ZK}$ at $I_{ZT2}$	$\alpha_{VZ}$ at $I_{ZT}$	
		V			mA		V	nA	$\Omega$		$10^{-4}/^{\circ}\text{C}$	
		MIN.	NOM.	MAX.							MIN.	MAX.
AZ23B2V7-G	D41	2.65	2.7	2.75	5	1	-	-	75 (< 83)	< 500	-9	-4
AZ23B3V0-G	D42	2.94	3.0	3.06	5	1	-	-	80 (< 95)	< 500	-9	-3
AZ23B3V3-G	D43	3.23	3.3	3.37	5	1	-	-	80 (< 95)	< 500	-8	-3
AZ23B3V6-G	D44	3.53	3.6	3.67	5	1	-	-	80 (< 95)	< 500	-8	-3
AZ23B3V9-G	D45	3.82	3.9	3.98	5	1	-	-	80 (< 95)	< 500	-7	-3
AZ23B4V3-G	D46	4.21	4.3	4.39	5	1	-	-	80 (< 95)	< 500	-6	-1
AZ23B4V7-G	D47	4.61	4.7	4.79	5	1	-	-	70 (< 78)	< 500	-5	2
AZ23B5V1-G	D48	5	5.1	5.2	5	1	> 0.8	100	30 (< 60)	< 480	-3	4
AZ23B5V6-G	D49	5.49	5.6	5.71	5	1	> 1	100	10 (< 40)	< 400	-2	6
AZ23B6V2-G	D50	6.08	6.2	6.32	5	1	> 2	100	4.8 (< 10)	< 200	-1	7
AZ23B6V8-G	D51	6.66	6.8	6.94	5	1	> 3	100	4.5 (< 8)	< 150	2	7
AZ23B7V5-G	D52	7.35	7.5	7.65	5	1	> 5	100	4 (< 7)	< 50	3	7
AZ23B8V2-G	D53	8.04	8.2	8.36	5	1	> 6	100	4.5 (< 7)	< 50	4	7
AZ23B9V1-G	D54	8.92	9.1	9.28	5	1	> 7	100	4.8 (< 10)	< 50	5	8
AZ23B10-G	D55	9.8	10	10.2	5	1	> 7.5	100	5.2 (< 15)	< 70	5	8
AZ23B11-G	D56	10.8	11	11.2	5	1	> 8.5	100	6 (< 20)	< 70	5	9
AZ23B12-G	D57	11.8	12	12.2	5	1	> 9	100	7 (< 20)	< 90	6	9
AZ23B13-G	D58	12.7	13	13.3	5	1	> 10	100	9 (< 25)	< 110	7	9
AZ23B15-G	D59	14.7	15	15.3	5	1	> 11	100	11 (< 30)	< 110	7	9
AZ23B16-G	D60	15.7	16	16.3	5	1	> 12	100	13 (< 40)	< 170	8	9.5
AZ23B18-G	D61	17.6	18	18.4	5	1	> 14	100	18 (< 50)	< 170	8	9.5
AZ23B20-G	D62	19.6	20	20.4	5	1	> 15	100	20 (< 50)	< 220	8	10
AZ23B22-G	D63	21.6	22	22.4	5	1	> 17	100	25 (< 55)	< 220	8	10
AZ23B24-G	D64	23.5	24	24.5	5	1	> 18	100	28 (< 80)	< 220	8	10
AZ23B27-G	D65	26.5	27	27.5	5	1	> 20	100	30 (< 80)	< 250	8	10
AZ23B30-G	D66	29.4	30	30.6	5	1	> 22.5	100	35 (< 80)	< 250	8	10
AZ23B33-G	D67	32.3	33	33.7	5	1	> 25	100	40 (< 80)	< 250	8	10
AZ23B36-G	D68	35.3	36	36.7	5	1	> 27	100	40 (< 90)	< 250	8	10
AZ23B39-G	D69	38.2	39	39.8	5	1	> 29	100	50 (< 90)	< 300	10	12
AZ23B43-G	D70	42.1	43	43.9	5	1	> 32	100	60 (< 100)	< 700	10	12
AZ23B47-G	D71	46.1	47	47.9	5	1	> 35	100	70 (< 100)	< 750	10	12
AZ23B51-G	D72	50	51	52	5	1	> 38	100	70 (< 100)	< 750	10	12

**Note**

<sup>(1)</sup> Tested with pulses  $t_p = 5\text{ ms}$

**TYPICAL CHARACTERISTICS** ( $T_{amb} = 25\text{ }^{\circ}\text{C}$ , unless otherwise specified)

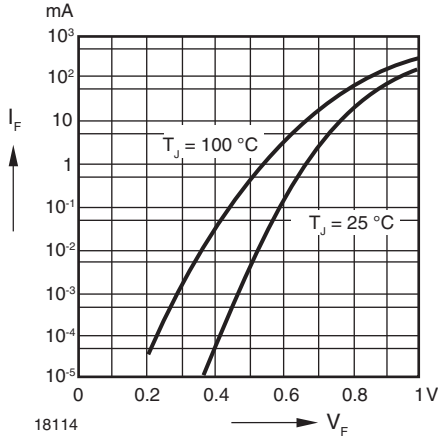

Fig. 1 - Forward Characteristics

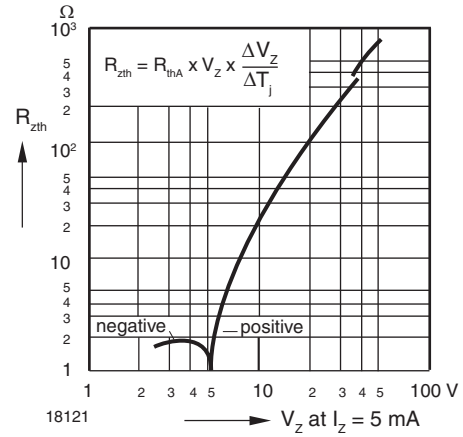

Fig. 4 - Thermal Differential Resistance vs. Zener Voltage

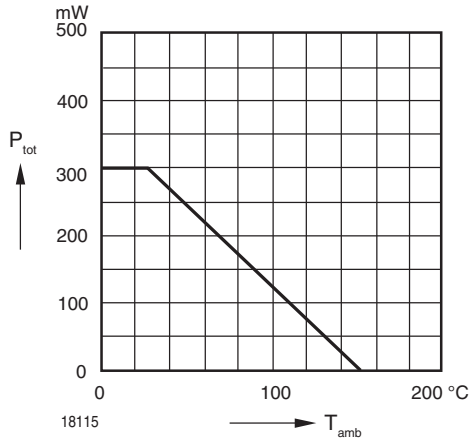

Fig. 2 - Admissible Power Dissipation vs. Ambient Temperature

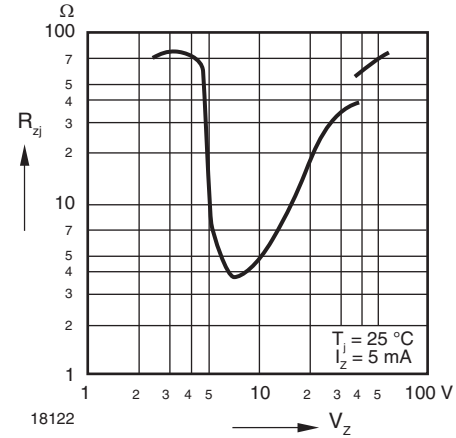

Fig. 5 - Dynamic Resistance vs. Zener Voltage

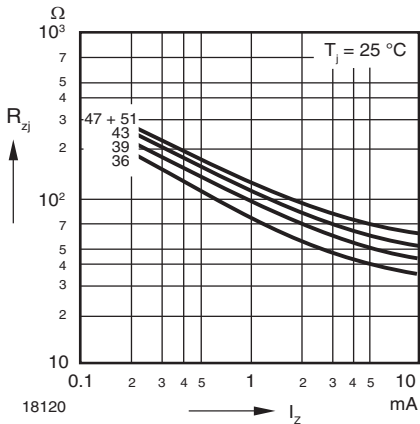

Fig. 3 - Dynamic Resistance vs. Zener Current

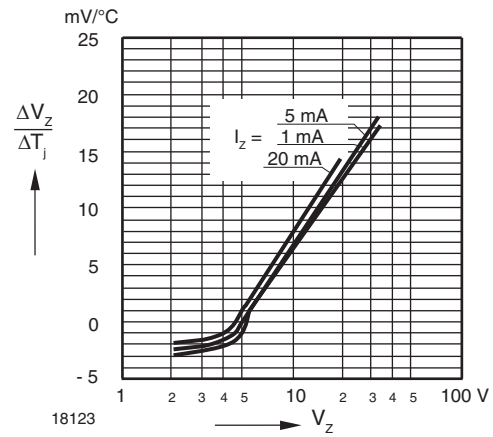

Fig. 6 - Temperature Dependence of Zener Voltage vs. Zener Voltage

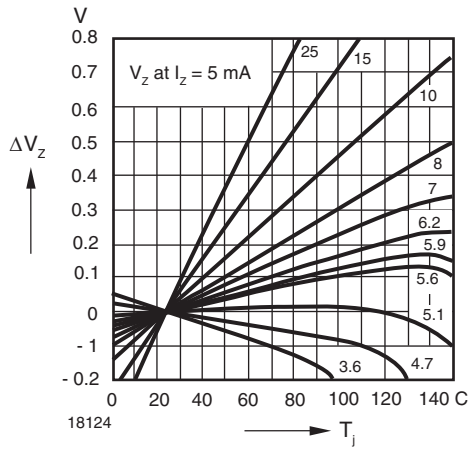

Fig. 7 - Change of Zener Voltage vs. Junction Temperature

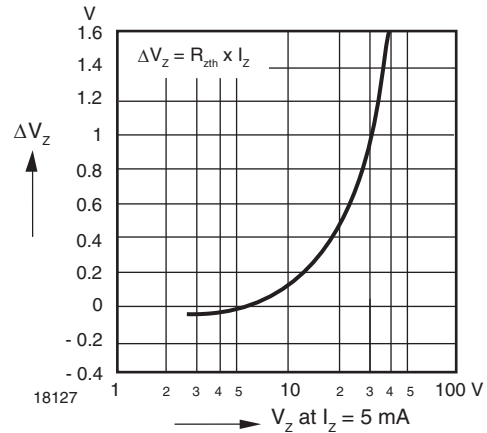

Fig. 10 - Change of Zener Voltage from Turn-on up to the Point of Thermal Equilibrium vs. Zener Voltage

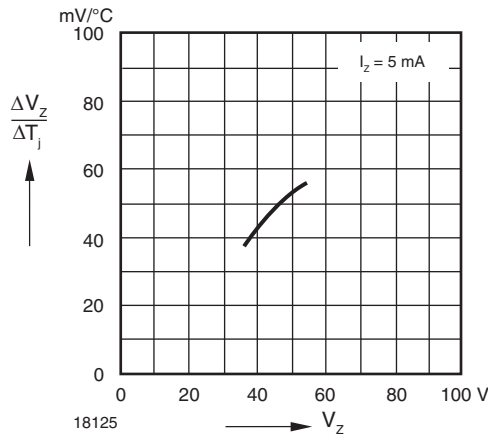

Fig. 8 - Temperature Dependence of Zener Voltage vs. Zener Voltage

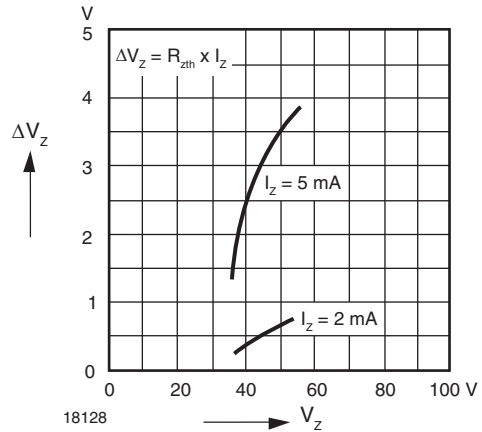

Fig. 11 - Change of Zener Voltage from Turn-on up to the Point of Thermal Equilibrium vs. Zener Voltage

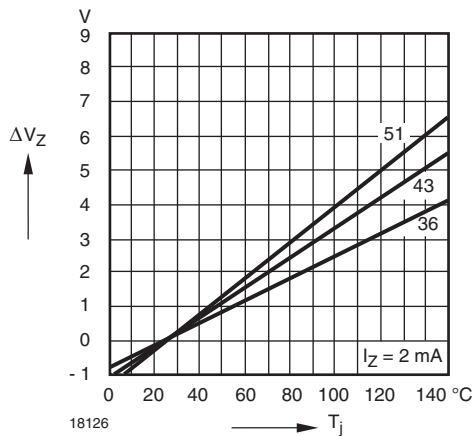

Fig. 9 - Change of Zener Voltage vs. Junction Temperature

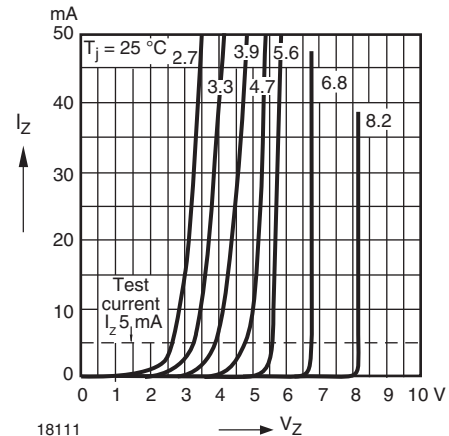

Fig. 12 - Breakdown Characteristics

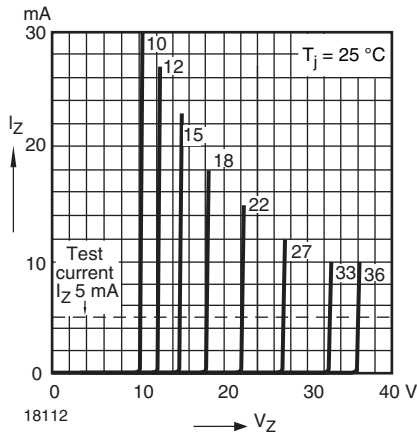

Fig. 13 - Breakdown Characteristics

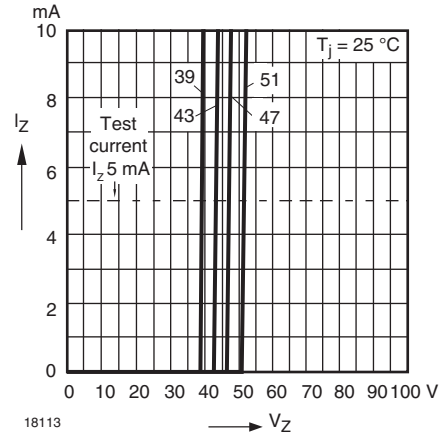
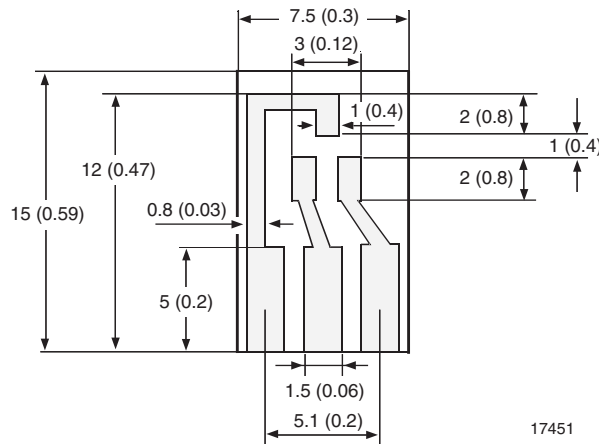

Fig. 14 - Breakdown Characteristics

**LAYOUT FOR  $R_{thJA}$  TEST**

Thickness: fiberglass 0.059" (1.5 mm)

Copper leads 0.012" (0.3 mm)





**PACKAGE DIMENSIONS** in millimeters (inches): **SOT-23**

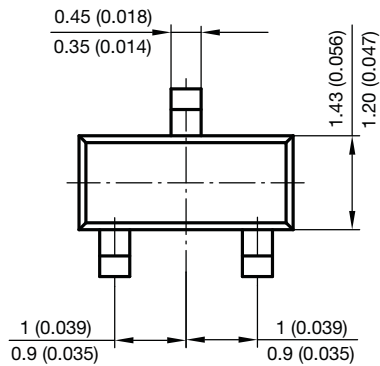
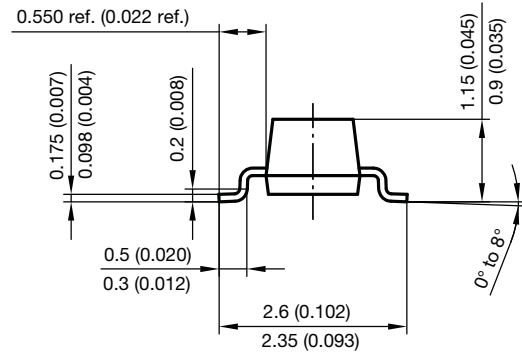
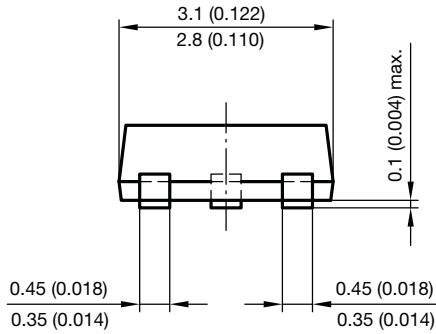

Foot print recommendation:

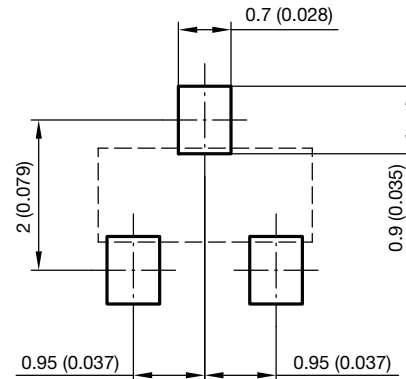

Document no.: 6.541-5014.01-4  
Rev. 8 - Date: 23.Sept.2009  
17418



## Disclaimer

ALL PRODUCT, PRODUCT SPECIFICATIONS AND DATA ARE SUBJECT TO CHANGE WITHOUT NOTICE TO IMPROVE RELIABILITY, FUNCTION OR DESIGN OR OTHERWISE.

Vishay Intertechnology, Inc., its affiliates, agents, and employees, and all persons acting on its or their behalf (collectively, "Vishay"), disclaim any and all liability for any errors, inaccuracies or incompleteness contained in any datasheet or in any other disclosure relating to any product.

Vishay makes no warranty, representation or guarantee regarding the suitability of the products for any particular purpose or the continuing production of any product. To the maximum extent permitted by applicable law, Vishay disclaims (i) any and all liability arising out of the application or use of any product, (ii) any and all liability, including without limitation special, consequential or incidental damages, and (iii) any and all implied warranties, including warranties of fitness for particular purpose, non-infringement and merchantability.

Statements regarding the suitability of products for certain types of applications are based on Vishay's knowledge of typical requirements that are often placed on Vishay products in generic applications. Such statements are not binding statements about the suitability of products for a particular application. It is the customer's responsibility to validate that a particular product with the properties described in the product specification is suitable for use in a particular application. Parameters provided in datasheets and / or specifications may vary in different applications and performance may vary over time. All operating parameters, including typical parameters, must be validated for each customer application by the customer's technical experts. Product specifications do not expand or otherwise modify Vishay's terms and conditions of purchase, including but not limited to the warranty expressed therein.

Except as expressly indicated in writing, Vishay products are not designed for use in medical, life-saving, or life-sustaining applications or for any other application in which the failure of the Vishay product could result in personal injury or death. Customers using or selling Vishay products not expressly indicated for use in such applications do so at their own risk. Please contact authorized Vishay personnel to obtain written terms and conditions regarding products designed for such applications.

No license, express or implied, by estoppel or otherwise, to any intellectual property rights is granted by this document or by any conduct of Vishay. Product names and markings noted herein may be trademarks of their respective owners.