

### Features

- Guard Ring Die Construction for Transient Protection
- Low Power Loss, High Efficiency
- High Surge Capability
- Very Low Forward Voltage Drop
- For Use in Low Voltage, High Frequency Inverters, Free Wheeling, and Polarity Protection Applications
- Plastic Material: UL Flammability Classification Rating 94V-0

### Mechanical Data

- Case: DPAK Molded Plastic
- Terminals: Solderable per MIL-STD-202, Method 208
- Polarity: See Diagram
- Marking: Type Number
- Weight: 0.4 grams (approx.)

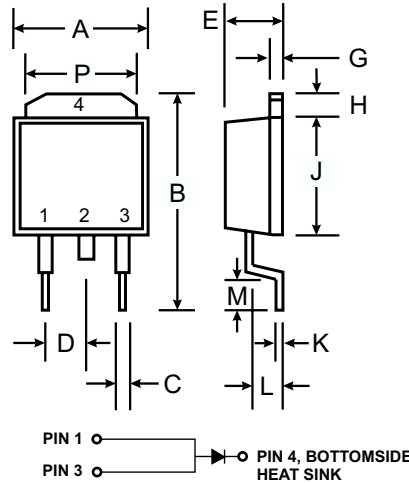

DPAK		
Dim	Min	Max
A	6.3	6.7
B	—	10
C	0.3	0.8
D	2.3 Nominal	
E	2.1	2.5
G	0.4	0.6
H	1.2	1.6
J	5.3	5.7
K	0.5 Nominal	
L	1.3	1.8
M	1.0	—
P	5.1	5.5
All Dimensions in mm		

Note: Pins 1 & 3 must be electrically connected at the printed circuit board.

### Maximum Ratings @ T<sub>A</sub> = 25°C unless otherwise specified

Single phase, half wave, 60Hz, resistive or inductive load.  
For capacitive load, derate current by 20%.

Characteristic	Symbol	Value	Unit
Peak Repetitive Reverse Voltage Working Peak Reverse Voltage DC Blocking Voltage	V <sub>RRM</sub> V <sub>RWM</sub> V <sub>R</sub>	35	V
RMS Reverse Voltage	V <sub>R(RMS)</sub>	25	V
Average Rectified Forward Current @ T <sub>C</sub> = 88°C	I <sub>F(AV)</sub>	8	A
Non-Repetitive Peak Forward Surge Current 8.3ms Single half sine-wave Superimposed on Rated Load (JEDEC Method)	I <sub>FSM</sub>	75	A
Typical Thermal Resistance Junction to Case (Note 2)	R <sub>θJC</sub>	6.0	°C/W
Typical Thermal Resistance Junction to Ambient (Note 2)	R <sub>θJA</sub>	80	°C/W
Operating Temperature Range	T <sub>J</sub>	-65 to +125	°C
Storage Temperature Range	T <sub>STG</sub>	-65 to +150	°C

### Electrical Characteristics @ T<sub>A</sub> = 25°C unless otherwise specified

Characteristic	Symbol	Min	Typ	Max	Unit	Test Condition
Reverse Breakdown Voltage (Note 1)	V <sub>(BR)R</sub>	35	—	—	V	I <sub>R</sub> = 1mA
Forward Voltage (Note 1)	V <sub>FM</sub>	—	0.48	0.51	V	I <sub>F</sub> = 8A, T <sub>S</sub> = 25°C I <sub>F</sub> = 8A, T <sub>S</sub> = 125°C
Peak Reverse Current (Note 1)	I <sub>RM</sub>	—	0.1	1.4	mA	T <sub>S</sub> = 25°C, V <sub>R</sub> = 35V T <sub>S</sub> = 100°C, V <sub>R</sub> = 35V
Junction Capacitance	C <sub>j</sub>	—	600	—	pF	f = 1.0MHz, V <sub>R</sub> = 4.0V DC

- Notes:
1. Short duration test pulse used to minimize self-heating effect.
  2. Mounted on PC board with 14mm<sup>2</sup> (.013mm thick) copper pad areas.

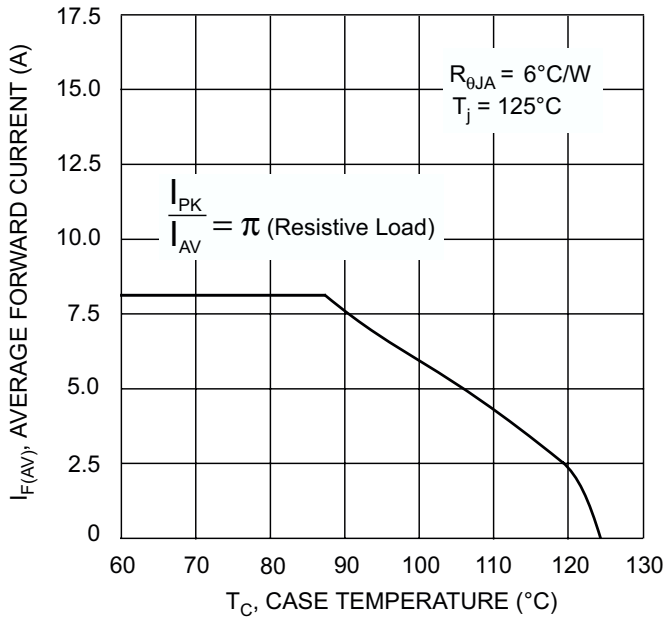

Fig. 1 Current Derating, Infinite Heatsink

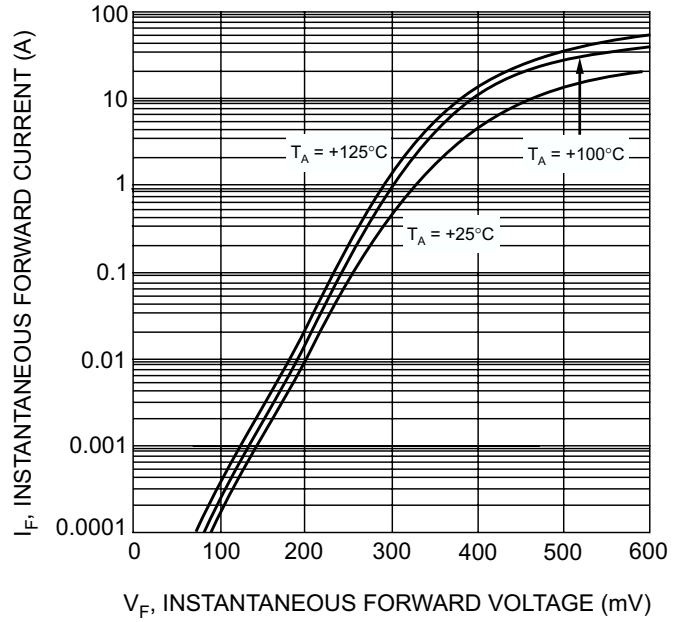

Fig. 2 Typical Forward Characteristics

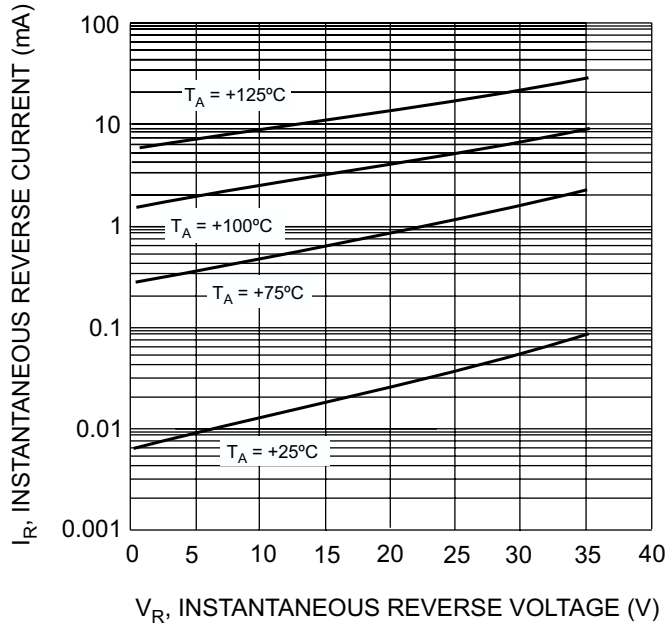

Fig. 3 Typical Reverse Characteristics

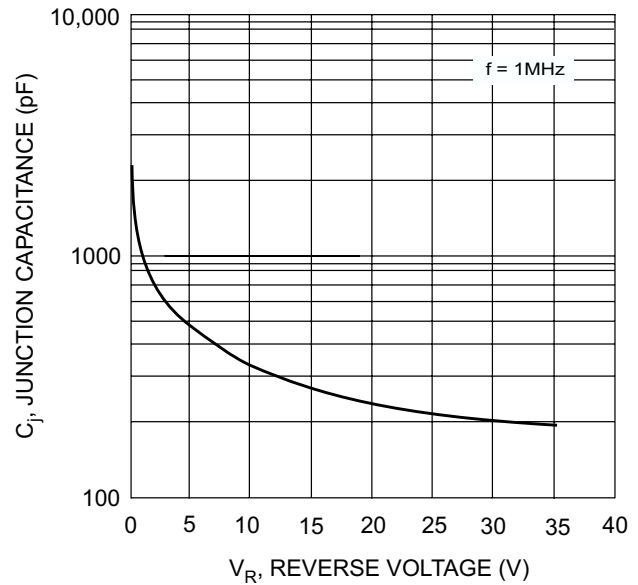

Fig. 4 Typical Junction Capacitance vs. Reverse Voltage

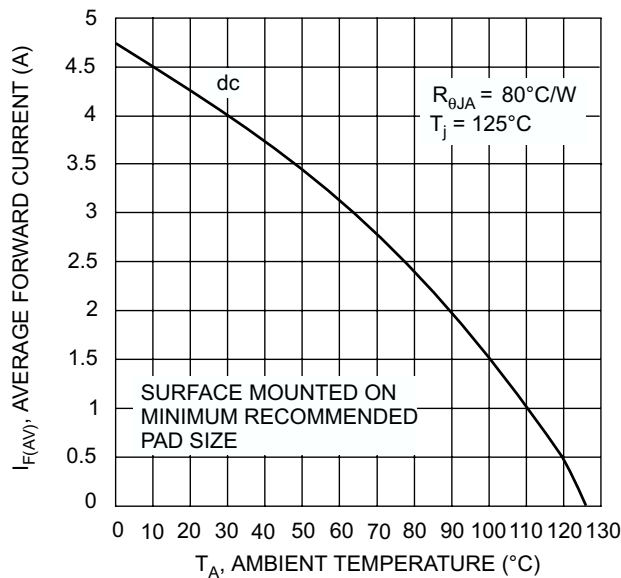

Fig. 5 Current Derating, Free Air

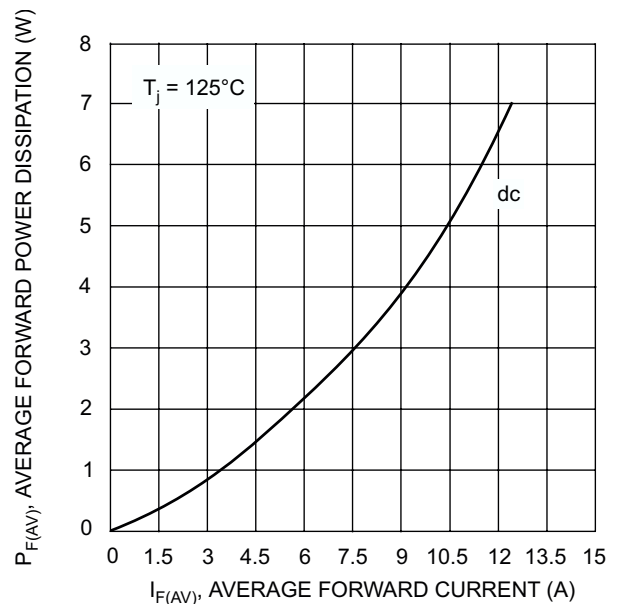

Fig. 6 Forward Power Dissipation