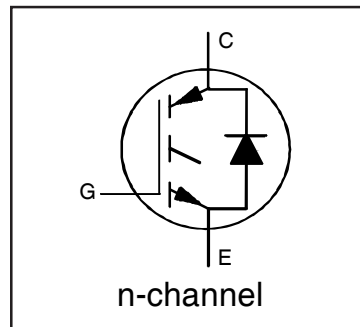


**INSULATED GATE BIPOLAR TRANSISTOR WITH ULTRA-LOW V<sub>F</sub> DIODE  
FOR INDUCTION HEATING AND SOFT SWITCHING APPLICATIONS**

### Features

- Low V<sub>CE(ON)</sub> trench IGBT technology
- Low switching losses
- Square RBSOA
- Ultra-low V<sub>F</sub> Diode
- 1300Vpk repetitive transient capacity
- 100% of the parts tested for I<sub>LM</sub> ①
- Positive V<sub>CE(ON)</sub> temperature co-efficient
- Tight parameter distribution
- Lead free package



$$V_{CES} = 1200V$$

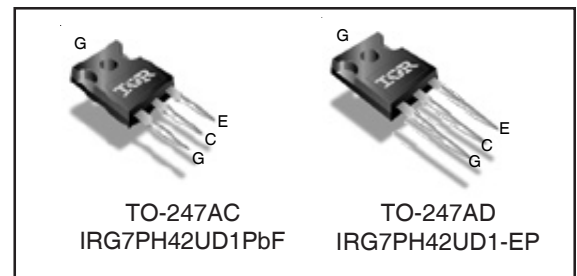
$$I_{NOMINAL} = 30A$$

$$T_{J(max)} = 150^{\circ}C$$

$$V_{CE(on)} \text{ typ.} = 1.7V$$

### Benefits

- Device optimized for induction heating and soft switching applications
- High Efficiency due to Low V<sub>CE(on)</sub>, low switching losses and Ultra-low V<sub>F</sub>
- Rugged transient performance for increased reliability
- Excellent current sharing in parallel operation
- Low EMI



<b>G</b>	<b>C</b>	<b>E</b>
Gate	Collector	Emitter

Base part number	Package Type	Standard Pack		Orderable Part Number
		Form	Quantity	
IRG7PH42UD1PbF	TO-247AC	Tube	25	IRG7PH42UD1PbF
IRG7PH42UD1-EP	TO-247AD	Tube	25	IRG7PH42UD1-EP

### Absolute Maximum Ratings

	Parameter	Max.	Units
V <sub>CES</sub>	Collector-to-Emitter Voltage	1200	V
V <sub>(BR) Transient</sub>	Repetitive Transient Collector-to-Emitter Voltage ⑦	1300	
I <sub>C</sub> @ T <sub>C</sub> = 25°C	Continuous Collector Current	85⑤	A
I <sub>C</sub> @ T <sub>C</sub> = 100°C	Continuous Collector Current	45	
I <sub>NOMINAL</sub>	Nominal Current	30	
I <sub>CM</sub>	Pulse Collector Current, V <sub>GE</sub> =15V ②⑥	200	
I <sub>LM</sub>	Clamped Inductive Load Current, V <sub>GE</sub> =20V ①	120	
I <sub>F</sub> @ T <sub>C</sub> = 25°C	Diode Continuous Forward Current	70	
I <sub>F</sub> @ T <sub>C</sub> = 100°C	Diode Continuous Forward Current	35	
I <sub>FRM</sub>	Diode Repetitive Peak Forward Current ②	120	V
V <sub>GE</sub>	Continuous Gate-to-Emitter Voltage	±30	
P <sub>D</sub> @ T <sub>C</sub> = 25°C	Maximum Power Dissipation	313	W
P <sub>D</sub> @ T <sub>C</sub> = 100°C	Maximum Power Dissipation	125	
T <sub>J</sub>	Operating Junction and	-55 to +150	°C
T <sub>STG</sub>	Storage Temperature Range		
	Soldering Temperature, for 10 sec.		
	Mounting Torque, 6-32 or M3 Screw	10 lbf-in (1.1 N-m)	

### Thermal Resistance

	Parameter	Min.	Typ.	Max.	Units
R <sub>θJC</sub> (IGBT)	Thermal Resistance Junction-to-Case-(each IGBT) ④	—	—	0.4	°C/W
R <sub>θJC</sub> (Diode)	Thermal Resistance Junction-to-Case-(each Diode) ④	—	—	1.05	
R <sub>θCS</sub>	Thermal Resistance, Case-to-Sink (flat, greased surface)	—	0.24	—	
R <sub>θJA</sub>	Thermal Resistance, Junction-to-Ambient (typical socket mount)	—	40	—	

**Electrical Characteristics @ T<sub>J</sub> = 25°C (unless otherwise specified)**

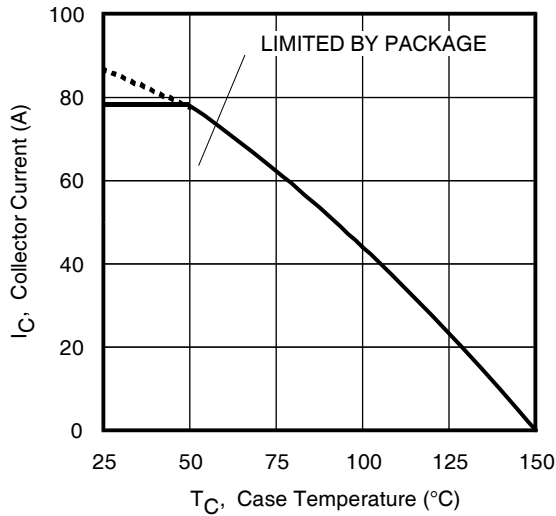
	Parameter	Min.	Typ.	Max.	Units	Conditions
V <sub>(BR)CES</sub>	Collector-to-Emitter Breakdown Voltage	1200	—	—	V	V <sub>GE</sub> = 0V, I <sub>C</sub> = 100μA ③
ΔV <sub>(BR)CES</sub> /ΔT <sub>J</sub>	Temperature Coeff. of Breakdown Voltage	—	1.2	—	V/°C	V <sub>GE</sub> = 0V, I <sub>C</sub> = 2.0mA (25°C-150°C)
V <sub>CE(on)</sub>	Collector-to-Emitter Saturation Voltage	—	1.7	2.0	V	I <sub>C</sub> = 30A, V <sub>GE</sub> = 15V, T <sub>J</sub> = 25°C
		—	2.0	—		I <sub>C</sub> = 30A, V <sub>GE</sub> = 15V, T <sub>J</sub> = 150°C
V <sub>GE(th)</sub>	Gate Threshold Voltage	3.0	—	6.0	V	V <sub>CE</sub> = V <sub>GE</sub> , I <sub>C</sub> = 1.0mA
g <sub>fe</sub>	Forward Transconductance	—	32	—	S	V <sub>CE</sub> = 50V, I <sub>C</sub> = 30A, PW = 80μs
I <sub>CES</sub>	Collector-to-Emitter Leakage Current	—	1.0	100	μA	V <sub>GE</sub> = 0V, V <sub>CE</sub> = 1200V
		—	230	—		V <sub>GE</sub> = 0V, V <sub>CE</sub> = 1200V, T <sub>J</sub> = 150°C
V <sub>FM</sub>	Diode Forward Voltage Drop	—	1.15	1.30	V	I <sub>F</sub> = 30A
		—	1.10	—		I <sub>F</sub> = 30A, T <sub>J</sub> = 150°C
I <sub>GES</sub>	Gate-to-Emitter Leakage Current	—	—	±100	nA	V <sub>GE</sub> = ±30V

**Switching Characteristics @ T<sub>J</sub> = 25°C (unless otherwise specified)**

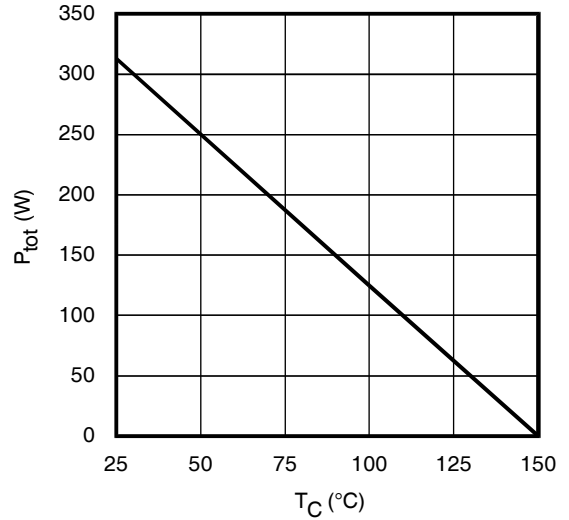
	Parameter	Min.	Typ.	Max.	Units	Conditions
Q <sub>g</sub>	Total Gate Charge (turn-on)	—	180	270	nC	I <sub>C</sub> = 30A
Q <sub>ge</sub>	Gate-to-Emitter Charge (turn-on)	—	24	36		V <sub>GE</sub> = 15V
Q <sub>gc</sub>	Gate-to-Collector Charge (turn-on)	—	70	110		V <sub>CC</sub> = 600V
E <sub>off</sub>	Turn-Off Switching Loss	—	1210	1450	μJ	I <sub>C</sub> = 30A, V <sub>CC</sub> = 600V, V <sub>GE</sub> = 15V R <sub>G</sub> = 10Ω, L = 200μH, T <sub>J</sub> = 25°C Energy losses include tail
t <sub>d(off)</sub>	Turn-Off delay time	—	270	290	ns	I <sub>C</sub> = 30A, V <sub>CC</sub> = 600V, V <sub>GE</sub> = 15V
t <sub>f</sub>	Fall time	—	35	43		R <sub>G</sub> = 10Ω, L = 200μH, T <sub>J</sub> = 25°C
E <sub>off</sub>	Turn-Off Switching Loss	—	1936	—	μJ	I <sub>C</sub> = 30A, V <sub>CC</sub> = 600V, V <sub>GE</sub> = 15V R <sub>G</sub> = 10Ω, L = 200μH, T <sub>J</sub> = 150°C Energy losses include tail
t <sub>d(off)</sub>	Turn-Off delay time	—	300	—	ns	I <sub>C</sub> = 30A, V <sub>CC</sub> = 600V, V <sub>GE</sub> = 15V
t <sub>f</sub>	Fall time	—	160	—		R <sub>G</sub> = 10Ω, L = 200μH, T <sub>J</sub> = 150°C
C <sub>ies</sub>	Input Capacitance	—	3390	—	pF	V <sub>GE</sub> = 0V
C <sub>oes</sub>	Output Capacitance	—	130	—		V <sub>CC</sub> = 30V
C <sub>res</sub>	Reverse Transfer Capacitance	—	83	—		f = 1.0Mhz
RBSOA	Reverse Bias Safe Operating Area	FULL SQUARE				T <sub>J</sub> = 150°C, I <sub>C</sub> = 120A V <sub>CC</sub> = 960V, V <sub>p</sub> = 1200V R <sub>G</sub> = 10Ω, V <sub>GE</sub> = +20V to 0V

**Notes:**

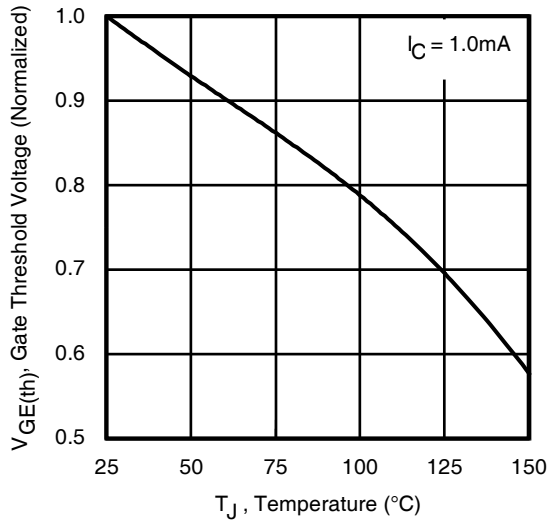
- ① V<sub>CC</sub> = 80% (V<sub>CES</sub>), V<sub>GE</sub> = 20V, L = 22μH, R<sub>G</sub> = 10Ω.
- ② Pulse width limited by max. junction temperature.
- ③ Refer to AN-1086 for guidelines for measuring V<sub>(BR)CES</sub> safely.
- ④ R<sub>θ</sub> is measured at T<sub>J</sub> of approximately 90°C.
- ⑤ Calculated continuous current based on maximum allowable junction temperature. Bond wire current limit is 78A. Note that current limitations arising from heating of the device leads may occur with some lead mounting arrangements.
- ⑥ FBSOA operating conditions only
- ⑦ V<sub>GE</sub> = 0V, T<sub>J</sub> = 75°C, PW ≤ 10μs.



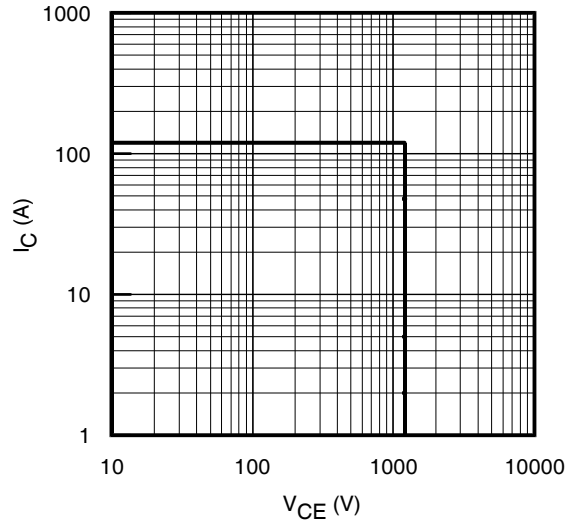
**Fig. 1** - Maximum DC Collector Current vs. Case Temperature



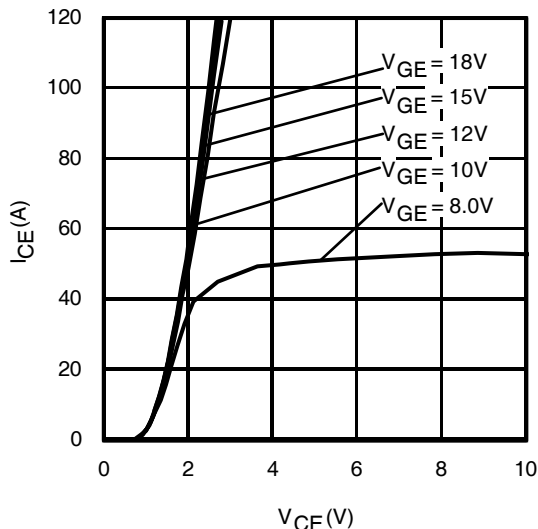
**Fig. 2** - Power Dissipation vs. Case Temperature



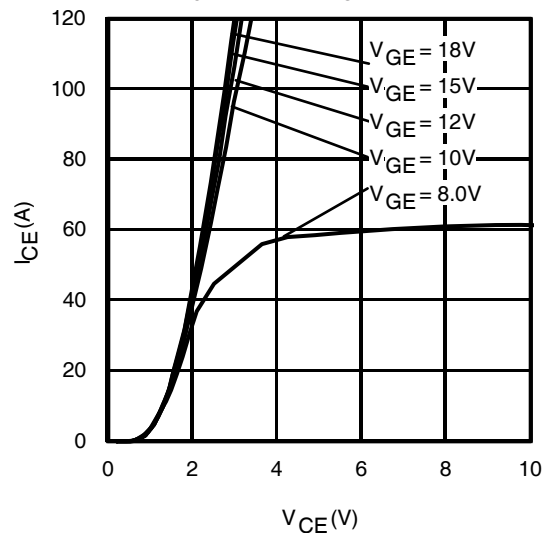
**Fig. 3** - Typical Gate Threshold Voltage (Normalized) vs. Junction Temperature



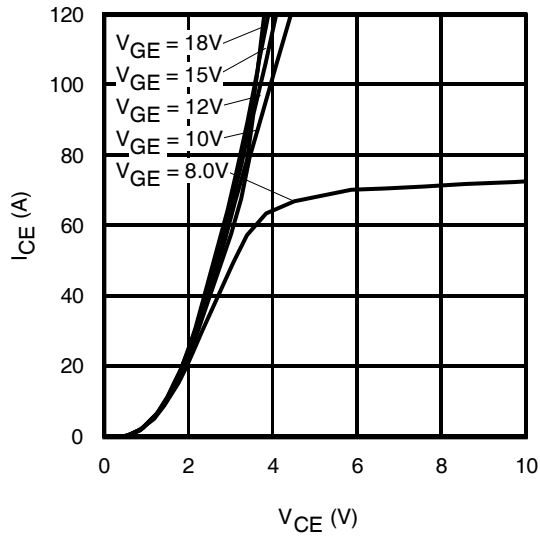
**Fig. 4** - Reverse Bias SOA  
 $T_J = 150^\circ\text{C}; V_{GE} = 20\text{V}$



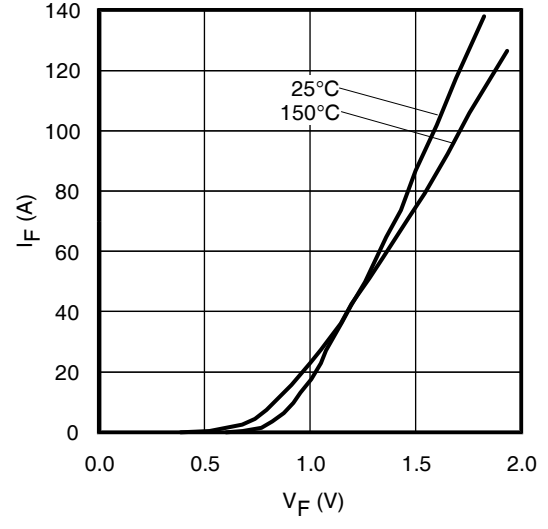
**Fig. 5** - Typ. IGBT Output Characteristics  
 $T_J = -40^\circ\text{C}; t_p = 80\mu\text{s}$



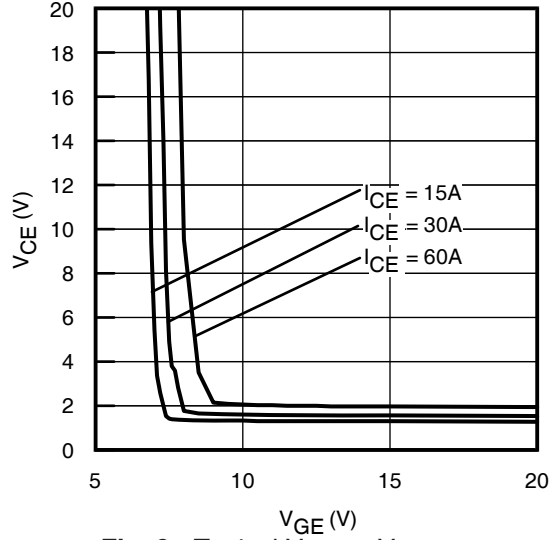
**Fig. 6** - Typ. IGBT Output Characteristics  
 $T_J = 25^\circ\text{C}; t_p = 80\mu\text{s}$



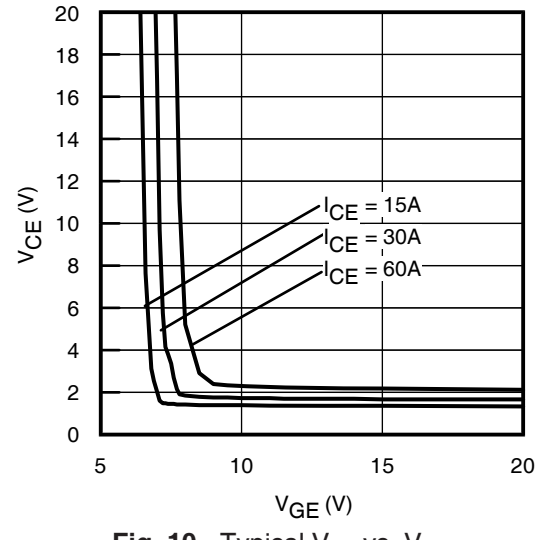
**Fig. 7 - Typ. IGBT Output Characteristics**  
 $T_J = 150^\circ\text{C}$ ;  $t_p = 80\mu\text{s}$



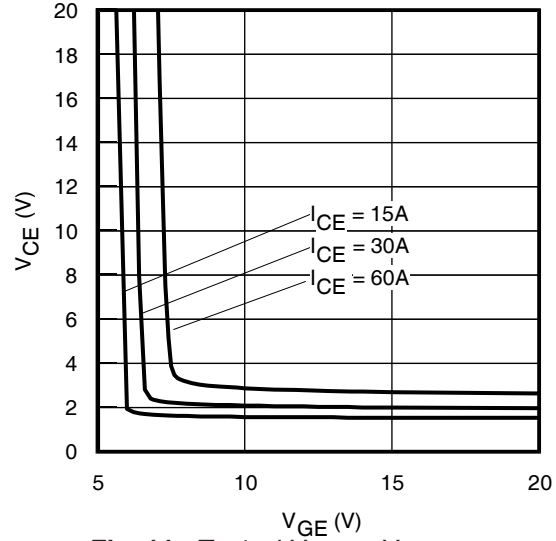
**Fig. 8 - Typ. Diode Forward Voltage Drop Characteristics**



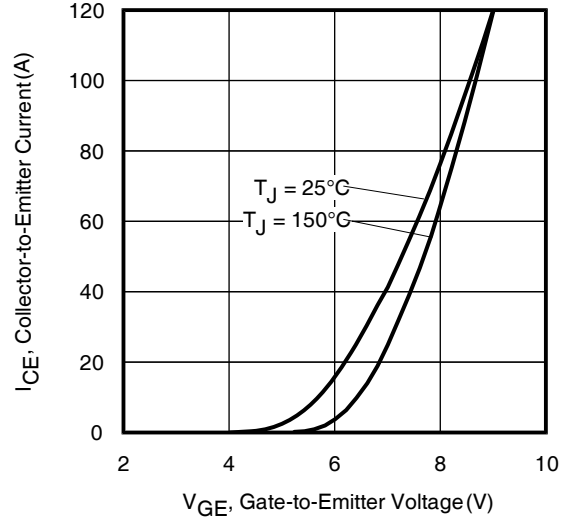
**Fig. 9 - Typical  $V_{CE}$  vs.  $V_{GE}$**   
 $T_J = -40^\circ\text{C}$



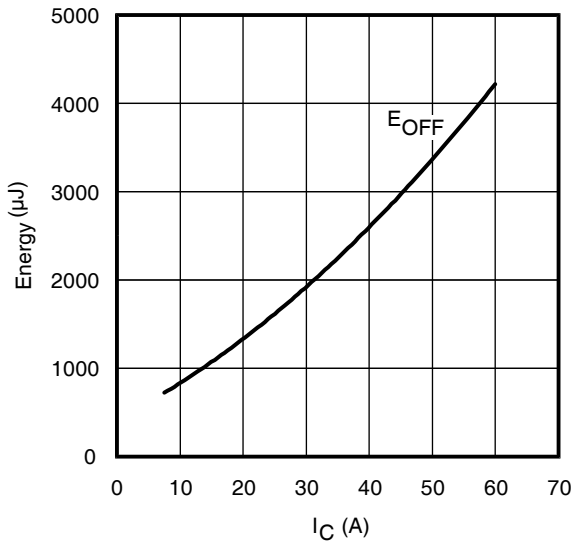
**Fig. 10 - Typical  $V_{CE}$  vs.  $V_{GE}$**   
 $T_J = 25^\circ\text{C}$



**Fig. 11 - Typical  $V_{CE}$  vs.  $V_{GE}$**   
 $T_J = 150^\circ\text{C}$

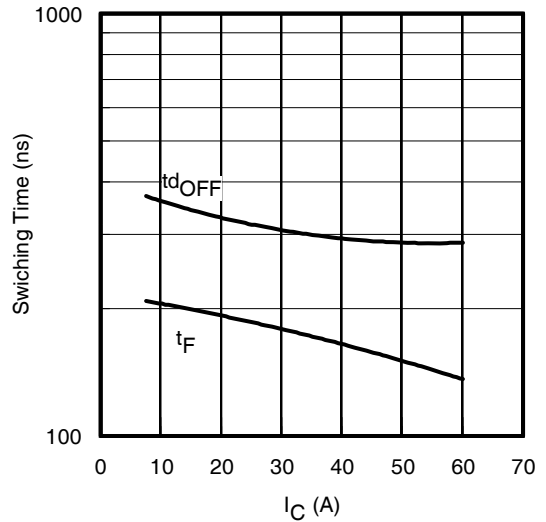


**Fig. 12 - Typ. Transfer Characteristics**  
 $V_{CE} = 50\text{V}$ ;  $t_p = 10\mu\text{s}$



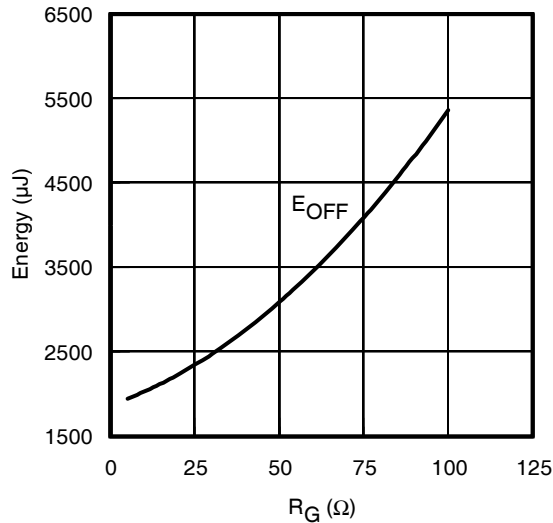
**Fig. 13** - Typ. Energy Loss vs. I<sub>C</sub>

T<sub>J</sub> = 150°C; L = 200μH; V<sub>CE</sub> = 600V, R<sub>G</sub> = 10Ω; V<sub>GE</sub> = 15V



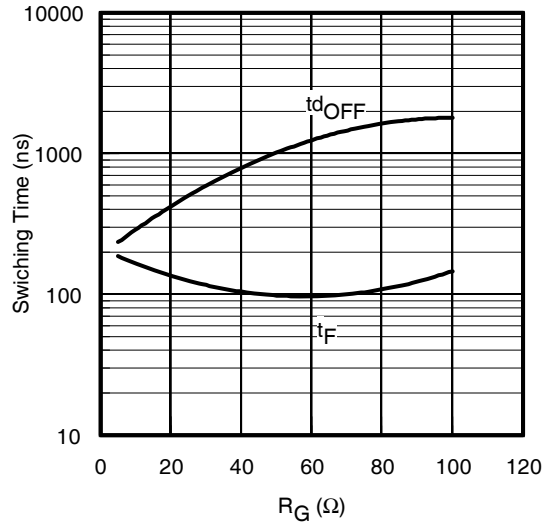
**Fig. 14** - Typ. Switching Time vs. I<sub>C</sub>

T<sub>J</sub> = 150°C; L = 200μH; V<sub>CE</sub> = 600V, R<sub>G</sub> = 10Ω; V<sub>GE</sub> = 15V



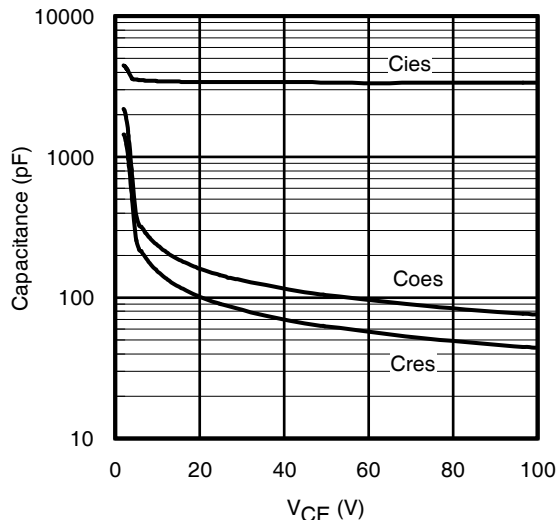
**Fig. 15** - Typ. Energy Loss vs. R<sub>G</sub>

T<sub>J</sub> = 150°C; L = 200μH; V<sub>CE</sub> = 600V, I<sub>CE</sub> = 30A; V<sub>GE</sub> = 15V

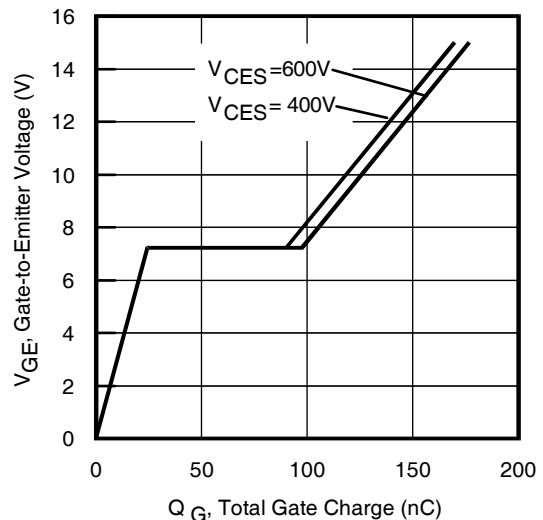


**Fig. 16** - Typ. Switching Time vs. R<sub>G</sub>

T<sub>J</sub> = 150°C; L = 200μH; V<sub>CE</sub> = 600V, I<sub>CE</sub> = 30A; V<sub>GE</sub> = 15V



**Fig. 17** - Typ. Capacitance vs. V<sub>CE</sub>  
V<sub>GE</sub> = 0V; f = 1MHz



**Fig. 18** - Typical Gate Charge vs. V<sub>GE</sub>  
I<sub>CE</sub> = 30A; L = 680μH

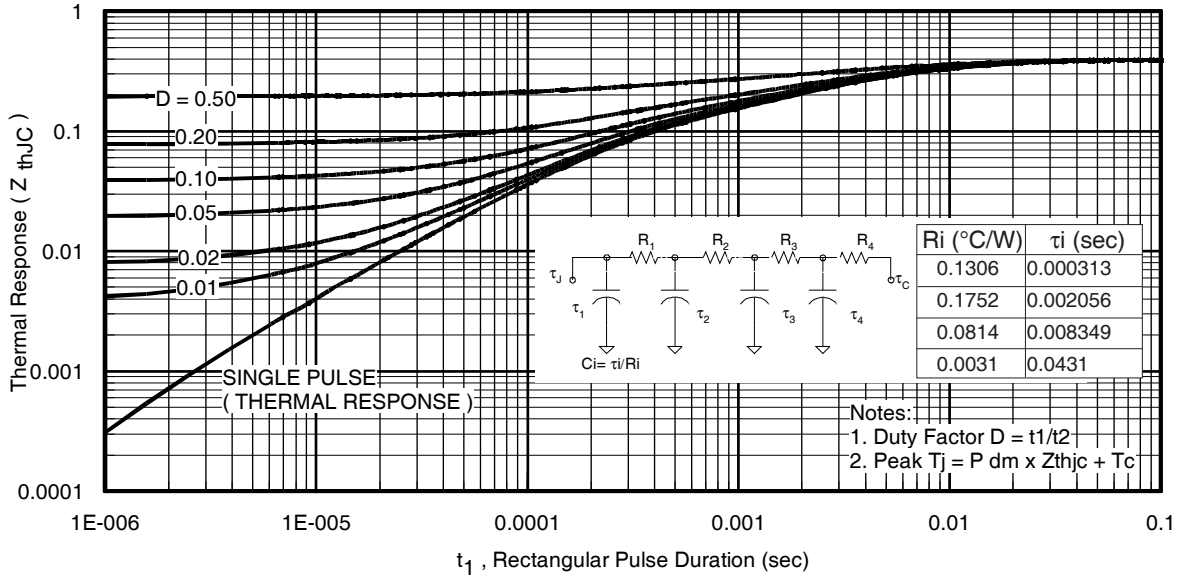


Fig 19. Maximum Transient Thermal Impedance, Junction-to-Case (IGBT)

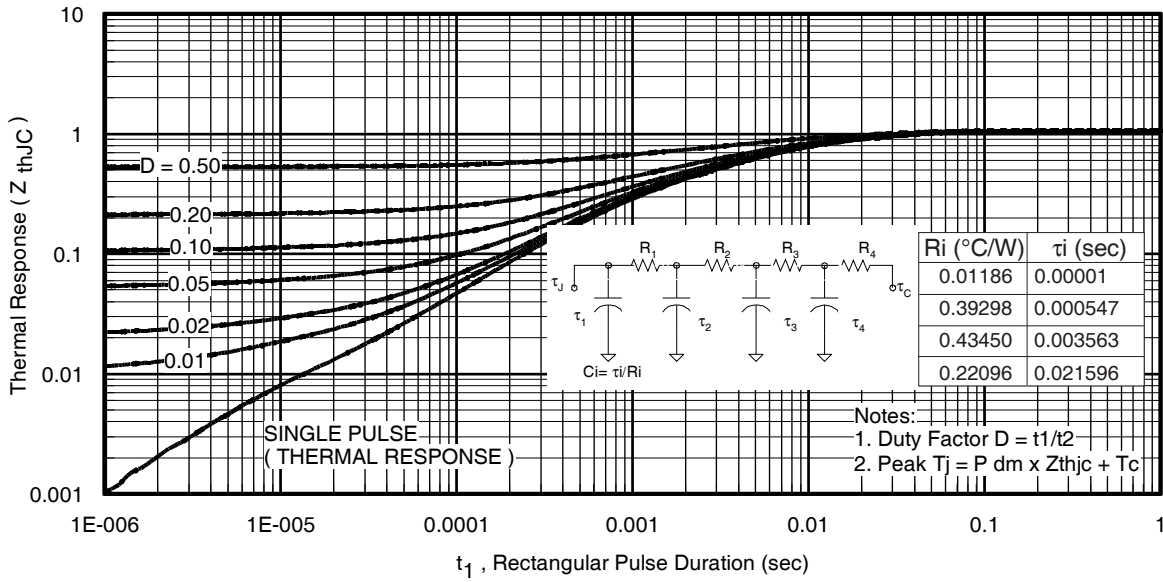


Fig. 20. Maximum Transient Thermal Impedance, Junction-to-Case (DIODE)

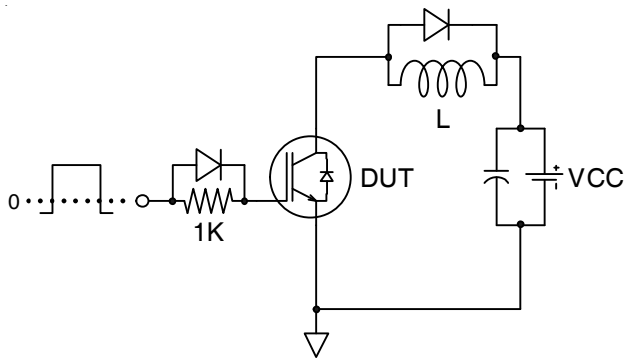


Fig.C.T.1 - Gate Charge Circuit (turn-off)

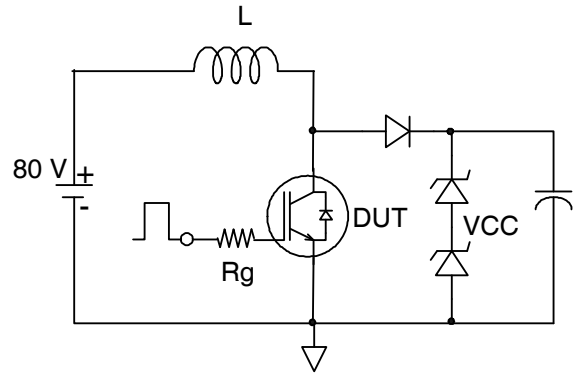


Fig.C.T.2 - RBSOA Circuit

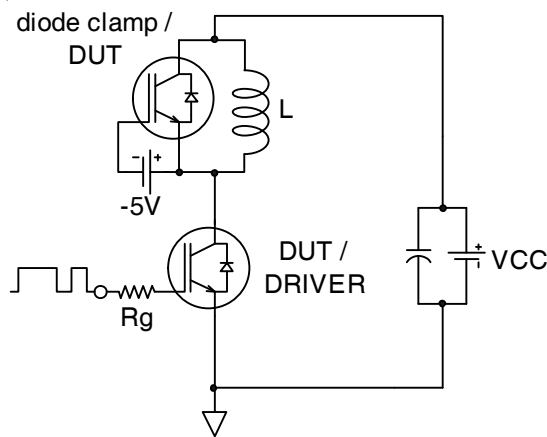


Fig.C.T.3 - Switching Loss Circuit

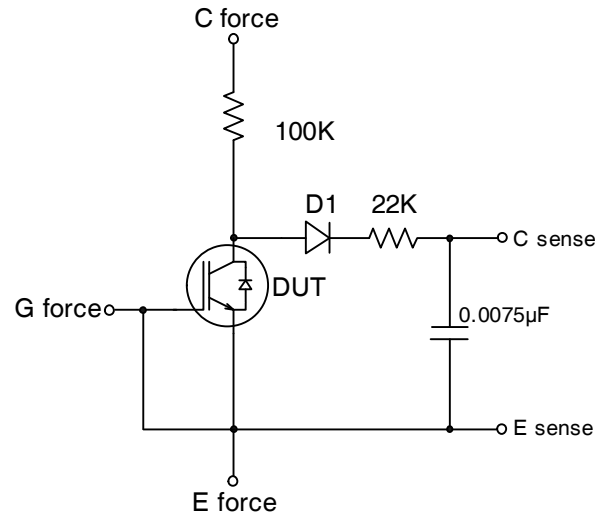


Fig.C.T.4 - BVCES Filter Circuit

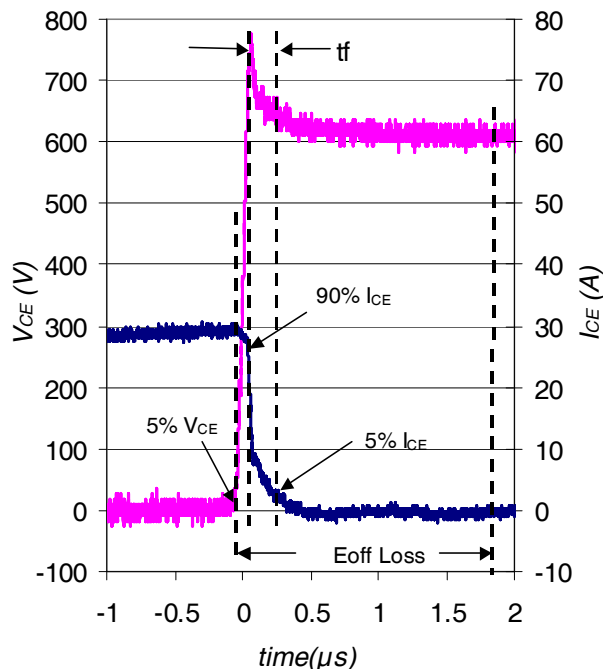


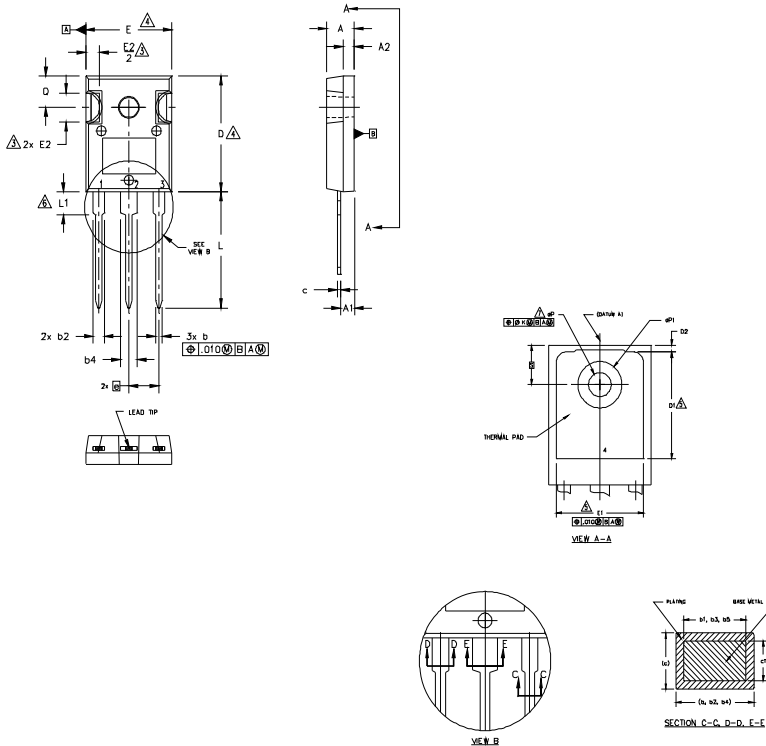
Fig. WF1 - Typ. Turn-off Loss Waveform  
@  $T_J = 150^\circ\text{C}$  using Fig. CT.3





## TO-247AD Package Outline

Dimensions are shown in millimeters (inches)



- NOTES:
1. DIMENSIONING AND TOLERANCING AS PER ASME Y14.5M 1994.
  2. DIMENSIONS ARE SHOWN IN INCHES.
  3. CONTOUR OF SLOT OPTIONAL.
  4. DIMENSION D & E DO NOT INCLUDE MOLD FLASH. MOLD FLASH SHALL NOT EXCEED .005" (0.127) PER SIDE. THESE DIMENSIONS ARE MEASURED AT THE OUTERMOST EXTREMES OF THE PLASTIC BODY.
  5. THERMAL PAD CONTOUR OPTIONAL WITHIN DIMENSIONS D1 & E1.
  6. LEAD FINISH UNCONTROLLED IN L1.
  7. ØP TO HAVE A MAXIMUM DRAFT ANGLE OF 1.5 ° TO THE TOP OF THE PART WITH A MAXIMUM HOLE DIAMETER OF .154 INCH.
  8. OUTLINE CONFORMS TO JEDEC OUTLINE TO-247AD.

SYMBOL	DIMENSIONS				NOTES
	INCHES		MILLIMETERS		
A	.183	.209	4.65	5.31	
A1	.087	.102	2.21	2.59	
A2	.059	.098	1.50	2.49	
b	.039	.055	0.99	1.40	
b1	.039	.053	0.99	1.35	
b2	.065	.094	1.65	2.39	
b3	.065	.092	1.65	2.34	
b4	.102	.135	2.59	3.43	
b5	.102	.133	2.59	3.38	
c	.015	.035	0.38	0.89	
c1	.015	.033	0.38	0.84	
D	.776	.815	19.71	20.70	4
D1	.515	-	13.08	-	5
D2	.020	.053	0.51	1.35	
E	.602	.625	15.29	15.87	4
E1	.530	-	13.46	-	
E2	.178	.216	4.52	5.49	
e	.215 BSC		5.46 BSC		
Øk	.010		0.25		
L	.780	.827	19.57	21.00	
L1	.146	.169	3.71	4.29	
ØP	.140	.144	3.56	3.66	
ØPI	-	.291	-	7.39	
O	.209	.224	5.31	5.69	
S	.217 BSC		5.51 BSC		

**LEAD ASSIGNMENTS**

**HEXFET**

- 1.- GATE
- 2.- DRAIN
- 3.- SOURCE
- 4.- DRAIN

**IGBTs, CoPACK**

- 1.- GATE
- 2.- COLLECTOR
- 3.- EMITTER
- 4.- COLLECTOR

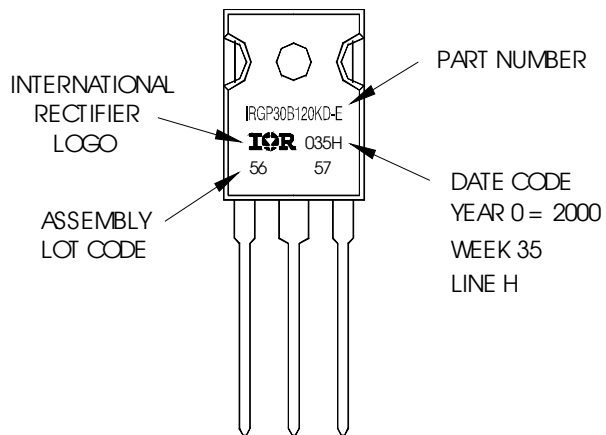
**DIODES**

- 1.- ANODE/OPEN
- 2.- CATHODE
- 3.- ANODE

## TO-247AD Part Marking Information

EXAMPLE: THIS IS AN IRGP30B120KD-E  
 WITH ASSEMBLY  
 LOT CODE 5657  
 ASSEMBLED ON WW35, 2000  
 IN THE ASSEMBLY LINE "H"

Note: "P" in assembly line position  
 indicates "Lead-Free"



TO-247AD package is not recommended for Surface Mount Application.

Note: For the most current drawing please refer to IR website at <http://www.irf.com/package/>

**Qualification Information†**

<b>Qualification Level</b>	Industrial† (per JEDEC JESD47F) ††	
<b>Moisture Sensitivity Level</b>	TO-247AC	N/A
	TO-247AD	N/A
<b>RoHS Compliant</b>	Yes	

† Qualification standards can be found at International Rectifier's web site: <http://www.irf.com/product-info/reliability/>

†† Applicable version of JEDEC standard at the time of product release.

**Revision History**

<b>Date</b>	<b>Comments</b>
4/19/2013	Document updated to new IR corporate template