

TinyLogic UHS Two-Input NAND Gate

NC7SZ00

Description

The NC7SZ00 is a single two-input NAND gate from ON Semiconductor's Ultra-High Speed (UHS) series of TinyLogic. The device is fabricated with advanced CMOS technology to achieve ultra-high speed with high output drive while maintaining low static power dissipation over a broad V_{CC} operating range. The device is specified to operate over the 1.65 V to 5.5 V V_{CC} operating range. The inputs and output are high impedance when V_{CC} is 0 V. Inputs tolerate voltages up to 5.5 V, independent of V_{CC} operating voltage.

Features

- Ultra-High Speed: $t_{PD} = 2.4$ ns (Typical) into 50 pF at 5 V V_{CC}
- High Output Drive: ± 24 mA at 3 V V_{CC}
- Broad V_{CC} Operating Range: 1.65 V to 5.5 V
- Matches Performance of LCX Operated at 3.3 V V_{CC}
- Power Down High-Impedance Inputs / Outputs
- Over-Voltage Tolerance Inputs Facilitate 5 V to 3 V Translation
- Proprietary Noise / EMI Reduction Circuitry
- Ultra-Small MicroPak™ Packages
- Space-Saving SC-74A and SC-88A Packages
- These Devices are Pb-Free, Halogen Free/BFR Free and are RoHS Compliant

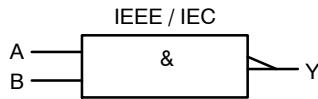

Figure 1. Logic Symbol



ON Semiconductor®

www.onsemi.com

MARKING DIAGRAMS



SIP6
CASE 127EB

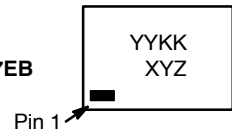

UDFN6
CASE 517DP

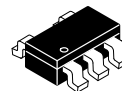
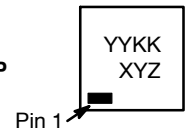

SC-74A
CASE 318BQ

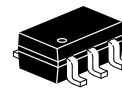
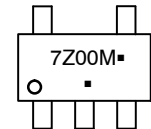

SC-88A
CASE 419A-02

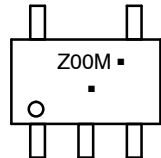

YY, 7Z00, Z00 = Specific Device Code
 KK = 2-Digit Lot Run Traceability Code
 XY = 2-Digit Date Code Format
 Z = Assembly Plant Code
 M = Data Code
 ■ = Pb-Free Package

(Note: Microdot may be in either location)

ORDERING INFORMATION

See detailed ordering, marking and shipping information in the package dimensions section on page 6 of this data sheet.

NC7SZ00

Pin Configurations

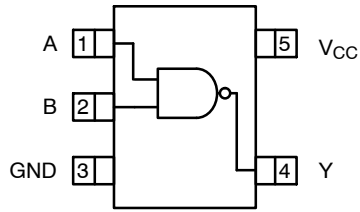

Figure 2. SC-88A and SC-74A (Top View)

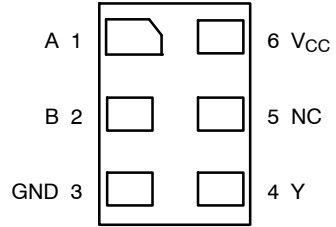

Figure 3. MicroPak (Top Through View)

PIN DEFINITIONS

Pin # SC-88A / SC74A	Pin # MicroPak	Name	Description
1	1	A	Input
2	2	B	Input
3	3	GND	Ground
4	4	Y	Output
5	6	V _{CC}	Supply Voltage
	5	NC	No Connect

FUNCTION TABLE

Inputs		Output
A	B	Y
L	L	H
L	H	H
H	L	H
H	H	L

H = HIGH Logic Level
L = LOW Logic Level

NC7SZ00

ABSOLUTE MAXIMUM RATINGS

Symbol	Parameter		Min	Max	Unit
V _{CC}	Supply Voltage		-0.5	6.5	V
V _{IN}	DC Input Voltage		-0.5	6.5	V
V _{OUT}	DC Output Voltage		-0.5	6.5	V
I _{IK}	DC Input Diode Current	V _{IN} < 0 V	-	-50	mA
I _{OK}	DC Output Diode Current	V _{OUT} < 0 V	-	-50	mA
I _{OUT}	DC Output Current		-	±50	mA
I _{CC} or I _{GND}	DC V _{CC} or Ground Current		-	±50	mA
T _{STG}	Storage Temperature Range		-65	+150	°C
T _J	Junction Temperature Under Bias		-	+150	°C
T _L	Junction Lead Temperature (Soldering, 10 Seconds)		-	+260	°C
P _D	Power Dissipation in Still Air	SC-74A	-	390	mW
		SC-88A	-	332	
		MicroPak-6	-	812	
		MicroPak2™-6	-	812	
ESD	Human Body Model, JEDEC: JESD22-A114		-	2000	V
	Charge Device Model, JEDEC: JESD22-C101		-	1000	

Stresses exceeding those listed in the Maximum Ratings table may damage the device. If any of these limits are exceeded, device functionality should not be assumed, damage may occur and reliability may be affected.

RECOMMENDED OPERATING CONDITIONS

Symbol	Parameter	Conditions	Min	Max	Unit
V _{CC}	Supply Voltage Operating		1.65	5.5	V
	Supply Voltage Data Retention		1.5	5.5	
V _{IN}	Input Voltage		0	5.5	V
V _{OUT}	Output Voltage		0	V _{CC}	V
T _A	Operating Temperature		-40	+85	°C
t _r , t _f	Input Rise and Fall Times	V _{CC} = 1.8 V, 2.5 V ±0.2 V	0	20	ns/V
		V _{CC} = 3.3 V ±0.3 V	0	10	
		V _{CC} = 5.0 V ±0.5 V	0	5	
θ _{JA}	Thermal Resistance	SC-74A	-	320	°C/W
		SC-88A	-	377	
		MicroPak-6	-	154	
		MicroPak2-6	-	154	

Functional operation above the stresses listed in the Recommended Operating Ranges is not implied. Extended exposure to stresses beyond the Recommended Operating Ranges limits may affect device reliability.

1. Unused inputs must be held HIGH or LOW. They may not float.

NC7SZ00

DC ELECTRICAL CHARACTERISTICS

Symbol	Parameter	V _{CC} (V)	Conditions	T _A = +25°C			T _A = -40 to +85°C		Unit
				Min	Typ	Max	Min	Max	
V _{IH}	HIGH Level Input Voltage	1.65 to 1.95		0.65 V _{CC}	-	-	0.65 V _{CC}	-	V
		2.30 to 5.50		0.70 V _{CC}	-	-	0.70 V _{CC}	-	
V _{IL}	LOW Level Input Voltage	1.65 to 1.95		-	-	0.35 V _{CC}	-	0.35 V _{CC}	V
		2.30 to 5.50		-	-	0.30 V _{CC}	-	0.30 V _{CC}	
V _{OH}	HIGH Level Output Voltage	1.65	V _{IN} = V _{IH} or V _{IL} , I _{OH} = -100 μA	1.55	1.65	-	1.55	-	V
		1.80		1.70	1.80	-	1.70	-	
		2.30		2.20	2.30	-	2.20	-	
		3.00		2.90	3.00	-	2.90	-	
		4.50		4.40	4.50	-	4.40	-	
		1.65	I _{OH} = -4 mA	1.29	1.52	-	1.29	-	
		2.30	I _{OH} = -8 mA	1.90	2.15	-	1.90	-	
		3.00	I _{OH} = -16 mA	2.40	2.80	-	2.40	-	
		3.00	I _{OH} = -24 mA	2.30	2.68	-	2.30	-	
		4.50	I _{OH} = -32 mA	3.80	4.20	-	3.80	-	
V _{OL}	LOW Level Output Voltage	1.65	V _{IN} = V _{IH} or V _{IL} , I _{OL} = 100 μA	-	0.00	0.10	-	0.08	V
		2.30		-	0.00	0.10	-	0.10	
		3.00		-	0.00	0.10	-	0.10	
		3.00		-	0.00	0.10	-	0.10	
		4.50		-	0.00	0.10	-	0.10	
		1.65	I _{OL} = 4 mA	-	0.80	0.24	-	0.24	
		2.30	I _{OL} = 8 mA	-	0.10	0.30	-	0.30	
		3.00	I _{OL} = 16 mA	-	0.15	0.40	-	0.40	
		3.00	I _{OL} = 24 mA	-	0.22	0.55	-	0.55	
		4.50	I _{OL} = 32 mA	-	0.22	0.55	-	0.55	
I _{IN}	Input Leakage Current	1.65 to 5.5	V _{IN} = 5.5 V, GND	-	-	±1	-	±10	μA
I _{OFF}	Power Off Leakage Current	0	V _{IN} or V _{OUT} = 5.5 V	-	-	1	-	10	μA
I _{CC}	Quiescent Supply Current	1.65 to 5.5	V _{IN} = 5.5 V, GND	-	-	2	-	20	μA

AC ELECTRICAL CHARACTERISTICS

Symbol	Parameter	V _{CC} (V)	Conditions	T _A = +25°C			T _A = -40 to +85°C		Unit
				Min	Typ	Max	Min	Max	
t _{PHL} , t _{PLH}	Propagation Delay (Figure 4, 5)	1.65	C _L = 15 pF, R _L = 1 MΩ	-	5.4	11.4	-	12.0	ns
		1.80		-	4.5	9.5	-	10.0	
		2.50 ±0.20		-	3.0	6.5	-	7.0	
		3.30 ±0.30	C _L = 50 pF, R _L = 500 Ω	-	2.4	4.5	-	4.7	
		5.00 ±0.50		-	2.0	3.9	-	4.1	
		3.30 ±0.30		-	2.9	5.0	-	5.2	
		5.00 ±0.50		-	2.4	4.3	-	4.5	
C _{IN}	Input Capacitance	0.00		-	4	-	-	-	pF
C _{PD}	Power Dissipation Capacitance (Note 2) (Figure 6)	3.30		-	24	-	-	-	pF
		5.00		-	30	-	-	-	

2. C_{PD} is defined as the value of the internal equivalent capacitance which is derived from dynamic operating current consumption (I_{CCD}) at no output loading and operating at 50% duty cycle. C_{PD} is related to I_{CCD} dynamic operating current by the expression:
 $I_{CCD} = (C_{PD}) (V_{CC}) (f_{IN}) + (I_{CCstatic})$.

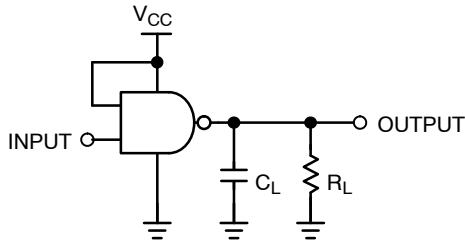

Figure 4. AC Test Circuit

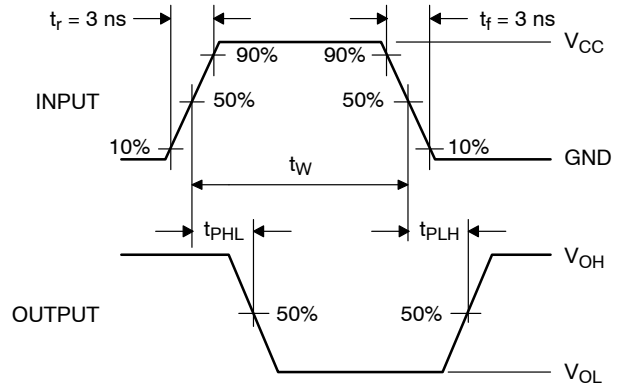
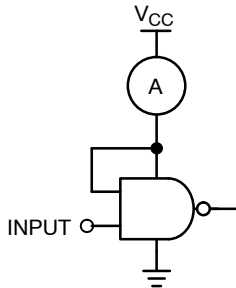

Figure 5. AC Waveforms



NOTE:

3. Input = AC Waveform; t_r = t_f = 1.8 ns;
 PRR = 10 MHz; Duty Cycle = 50%.

Figure 6. I_{CCD} Test Circuit

NC7SZ00

ORDERING INFORMATION

Part Number	Top Mark	Package	Shipping [†]
NC7SZ00M5X	7Z00	SC-74A	3000 / Tape & Reel
NC7SZ00P5X	Z00	SC-88A	3000 / Tape & Reel
NC7SZ00L6X	YY	SIP6, MicroPak	5000 / Tape & Reel
NC7SZ00FHX	YY	UDFN6, MicroPak2	5000 / Tape & Reel

[†]For information on tape and reel specifications, including part orientation and tape sizes, please refer to our Tape and Reel Packaging Specifications Brochure, BRD8011/D.

MicroPak and MicroPak2 are trademarks of Semiconductor Components Industries, LLC (SCILLC) or its subsidiaries in the United States and/or other countries.

MECHANICAL CASE OUTLINE

PACKAGE DIMENSIONS

ON Semiconductor®



SIP6 1.45X1.0
CASE 127EB
ISSUE O

DATE 31 AUG 2016

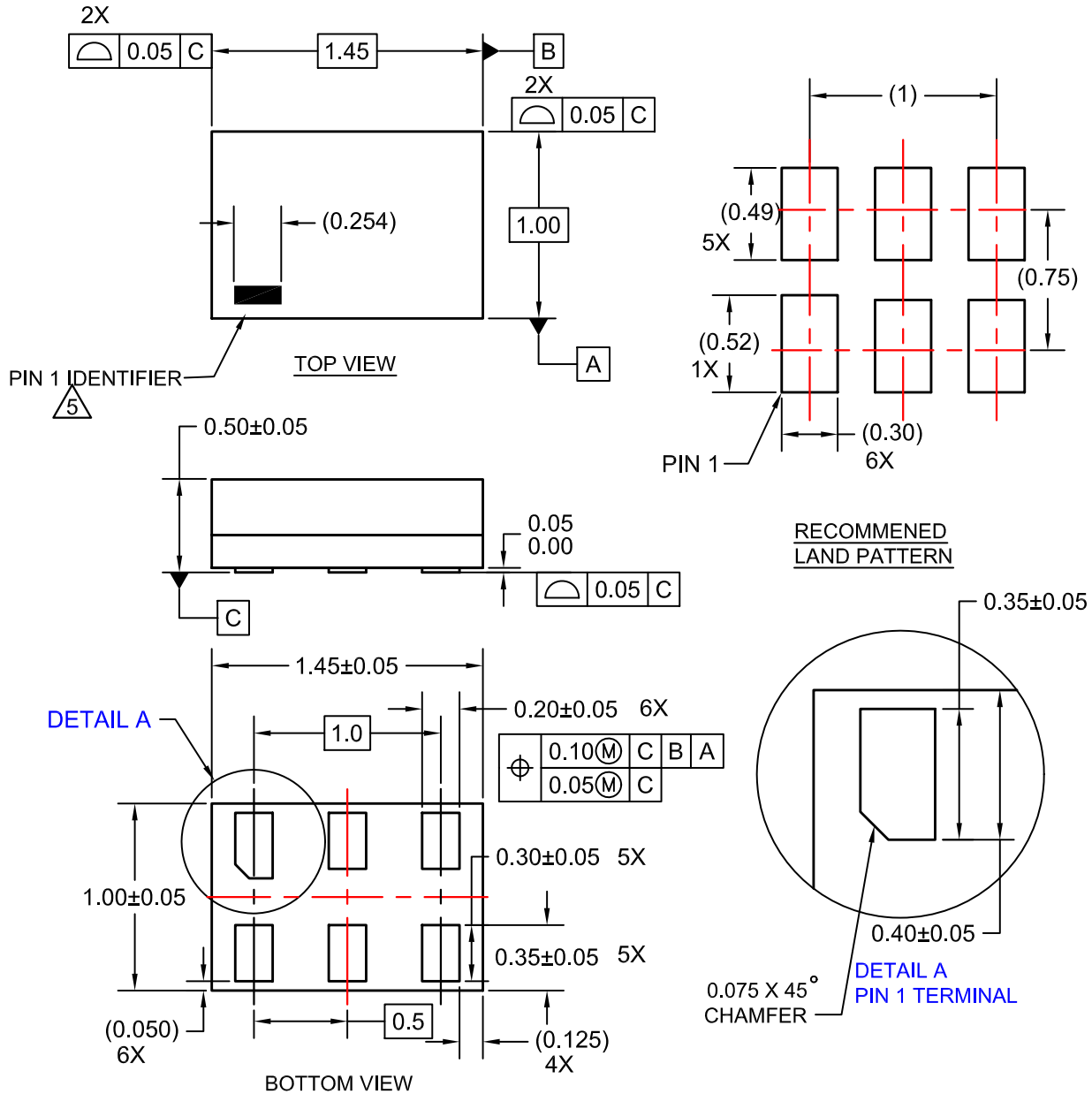

NOTES:

1. CONFORMS TO JEDEC STANDARD MO-252 VARIATION UAAD
2. DIMENSIONS ARE IN MILLIMETERS
3. DRAWING CONFORMS TO ASME Y14.5M-2009
4. PIN ONE IDENTIFIER IS 2X LENGTH OF ANY OTHER LINE IN THE MARK CODE LAYOUT.

DOCUMENT NUMBER:	98AON13590G	Electronic versions are uncontrolled except when accessed directly from the Document Repository. Printed versions are uncontrolled except when stamped "CONTROLLED COPY" in red.
DESCRIPTION:	SIP6 1.45X1.0	PAGE 1 OF 1

ON Semiconductor and are trademarks of Semiconductor Components Industries, LLC dba ON Semiconductor or its subsidiaries in the United States and/or other countries. ON Semiconductor reserves the right to make changes without further notice to any products herein. ON Semiconductor makes no warranty, representation or guarantee regarding the suitability of its products for any particular purpose, nor does ON Semiconductor assume any liability arising out of the application or use of any product or circuit, and specifically disclaims any and all liability, including without limitation special, consequential or incidental damages. ON Semiconductor does not convey any license under its patent rights nor the rights of others.

MECHANICAL CASE OUTLINE

PACKAGE DIMENSIONS

ON Semiconductor®

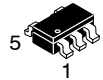

SCALE 2:1

SC-74A CASE 318BQ ISSUE B

DATE 18 JAN 2018

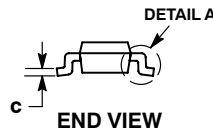
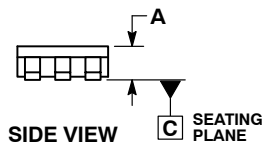
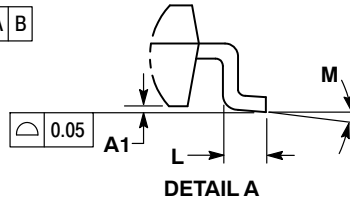
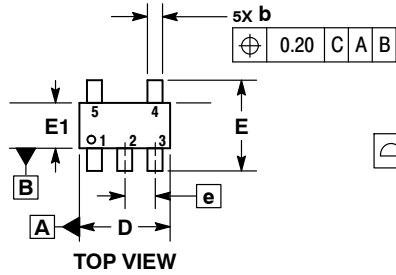

NOTES:

1. DIMENSIONING AND TOLERANCING PER ASME Y14.5M, 1994.
2. CONTROLLING DIMENSION: MILLIMETERS.
3. MAXIMUM LEAD THICKNESS INCLUDES LEAD FINISH THICKNESS. MINIMUM LEAD THICKNESS IS THE MINIMUM THICKNESS OF BASE MATERIAL.
4. DIMENSIONS A AND B DO NOT INCLUDE MOLD FLASH, PROTRUSIONS, OR GATE BURRS. MOLD FLASH, PROTRUSIONS, OR GATE BURRS SHALL NOT EXCEED 0.15 PER SIDE.

DIM	MILLIMETERS	
	MIN	MAX
A	0.90	1.10
A1	0.01	0.10
b	0.25	0.50
c	0.10	0.26
D	2.85	3.15
E	2.50	3.00
E1	1.35	1.65
e	0.95 BSC	
L	0.20	0.60
M	0°	10°

RECOMMENDED SOLDERING FOOTPRINT*

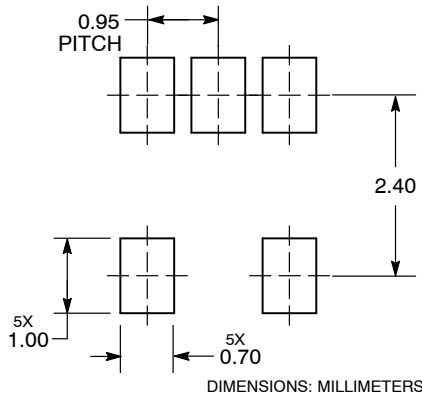

GENERIC MARKING DIAGRAM*

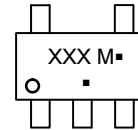

- XXX = Specific Device Code
- M = Date Code
- = Pb-Free Package

(Note: Microdot may be in either location)

*This information is generic. Please refer to device data sheet for actual part marking. Pb-Free indicator, "G" or microdot "▪", may or may not be present. Some products may not follow the Generic Marking.

*For additional information on our Pb-Free strategy and soldering details, please download the ON Semiconductor Soldering and Mounting Techniques Reference Manual, SOLDERRM/D.

DOCUMENT NUMBER:	98AON66279G	Electronic versions are uncontrolled except when accessed directly from the Document Repository. Printed versions are uncontrolled except when stamped "CONTROLLED COPY" in red.
DESCRIPTION:	SC-74A	PAGE 1 OF 1

ON Semiconductor and are trademarks of Semiconductor Components Industries, LLC dba ON Semiconductor or its subsidiaries in the United States and/or other countries. ON Semiconductor reserves the right to make changes without further notice to any products herein. ON Semiconductor makes no warranty, representation or guarantee regarding the suitability of its products for any particular purpose, nor does ON Semiconductor assume any liability arising out of the application or use of any product or circuit, and specifically disclaims any and all liability, including without limitation special, consequential or incidental damages. ON Semiconductor does not convey any license under its patent rights nor the rights of others.

MECHANICAL CASE OUTLINE

PACKAGE DIMENSIONS

ON Semiconductor®



SCALE 2:1

SC-88A (SC-70-5/SOT-353)
CASE 419A-02
ISSUE L

DATE 17 JAN 2013

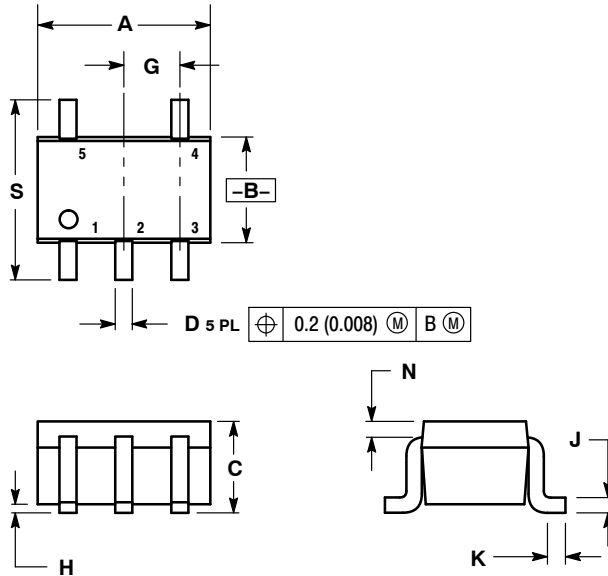

SOLDER FOOTPRINT

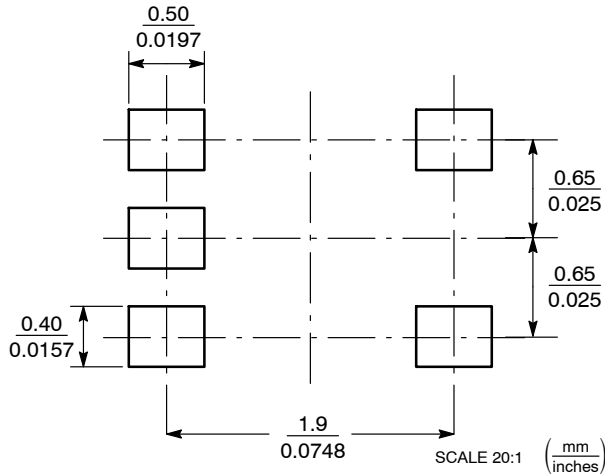

NOTES:

1. DIMENSIONING AND TOLERANCING PER ANSI Y14.5M, 1982.
2. CONTROLLING DIMENSION: INCH.
3. 419A-01 OBSOLETE. NEW STANDARD 419A-02.
4. DIMENSIONS A AND B DO NOT INCLUDE MOLD FLASH, PROTRUSIONS, OR GATE BURRS.

DIM	INCHES		MILLIMETERS	
	MIN	MAX	MIN	MAX
A	0.071	0.087	1.80	2.20
B	0.045	0.053	1.15	1.35
C	0.031	0.043	0.80	1.10
D	0.004	0.012	0.10	0.30
G	0.026 BSC		0.65 BSC	
H	---	0.004	---	0.10
J	0.004	0.010	0.10	0.25
K	0.004	0.012	0.10	0.30
N	0.008 REF		0.20 REF	
S	0.079	0.087	2.00	2.20

GENERIC MARKING DIAGRAM*

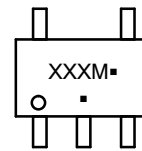

- XXX = Specific Device Code
- M = Date Code
- = Pb-Free Package

(Note: Microdot may be in either location)

*This information is generic. Please refer to device data sheet for actual part marking. Pb-Free indicator, "G" or microdot "■", may or may not be present. Some products may not follow the Generic Marking.

- | | | | | |
|--|--|--|--|--|
| <p>STYLE 1:
PIN 1. BASE
2. EMITTER
3. BASE
4. COLLECTOR
5. COLLECTOR</p> | <p>STYLE 2:
PIN 1. ANODE
2. EMITTER
3. BASE
4. COLLECTOR
5. CATHODE</p> | <p>STYLE 3:
PIN 1. ANODE 1
2. N/C
3. ANODE 2
4. CATHODE 2
5. CATHODE 1</p> | <p>STYLE 4:
PIN 1. SOURCE 1
2. DRAIN 1/2
3. SOURCE 1
4. GATE 1
5. GATE 2</p> | <p>STYLE 5:
PIN 1. CATHODE
2. COMMON ANODE
3. CATHODE 2
4. CATHODE 3
5. CATHODE 4</p> |
| <p>STYLE 6:
PIN 1. EMITTER 2
2. BASE 2
3. EMITTER 1
4. COLLECTOR
5. COLLECTOR 2/BASE 1</p> | <p>STYLE 7:
PIN 1. BASE
2. EMITTER
3. BASE
4. COLLECTOR
5. COLLECTOR</p> | <p>STYLE 8:
PIN 1. CATHODE
2. COLLECTOR
3. N/C
4. BASE
5. EMITTER</p> | <p>STYLE 9:
PIN 1. ANODE
2. CATHODE
3. ANODE
4. ANODE
5. ANODE</p> | <p>Note: Please refer to datasheet for style callout. If style type is not called out in the datasheet refer to the device datasheet pinout or pin assignment.</p> |

DOCUMENT NUMBER:	98ASB42984B	Electronic versions are uncontrolled except when accessed directly from the Document Repository. Printed versions are uncontrolled except when stamped "CONTROLLED COPY" in red.
DESCRIPTION:	SC-88A (SC-70-5/SOT-353)	PAGE 1 OF 1

ON Semiconductor and ON are trademarks of Semiconductor Components Industries, LLC dba ON Semiconductor or its subsidiaries in the United States and/or other countries. ON Semiconductor reserves the right to make changes without further notice to any products herein. ON Semiconductor makes no warranty, representation or guarantee regarding the suitability of its products for any particular purpose, nor does ON Semiconductor assume any liability arising out of the application or use of any product or circuit, and specifically disclaims any and all liability, including without limitation special, consequential or incidental damages. ON Semiconductor does not convey any license under its patent rights nor the rights of others.



UDFN6 1.0X1.0, 0.35P
CASE 517DP
ISSUE O

DATE 31 AUG 2016

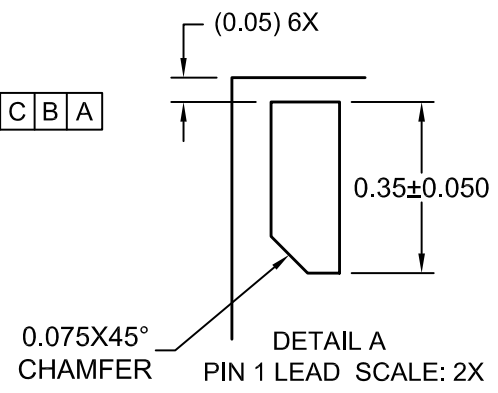
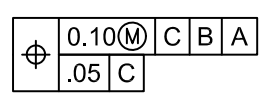
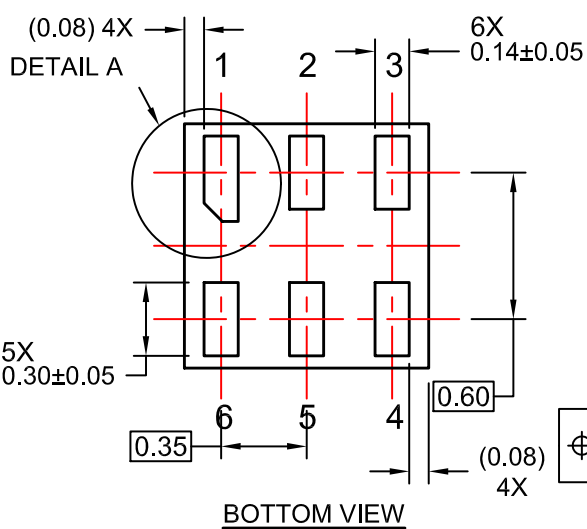
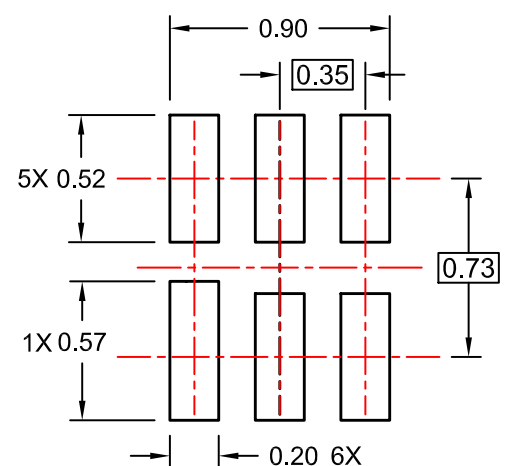
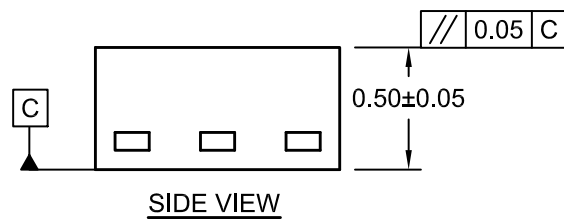
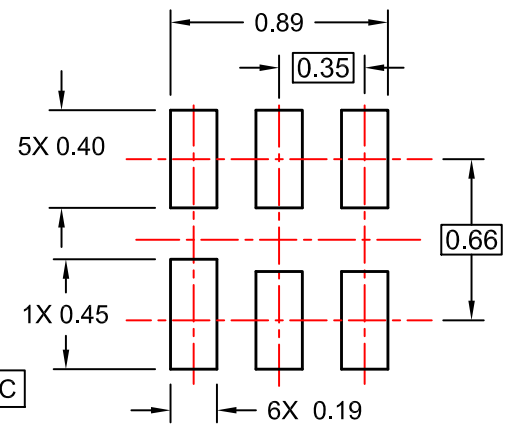
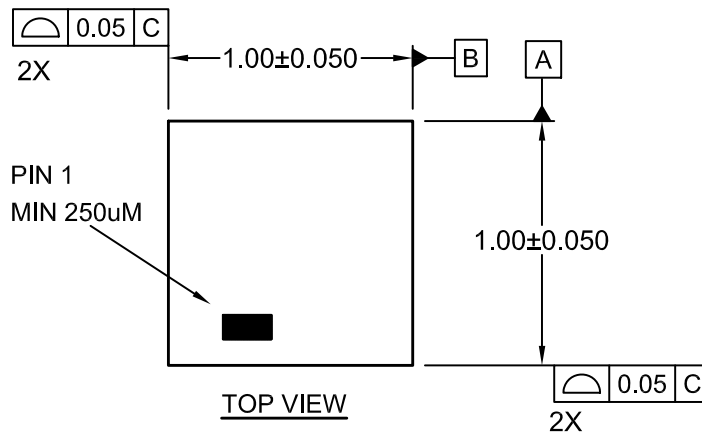

- NOTES:
- A. COMPLIES TO JEDEC MO-252 STANDARD
 - B. DIMENSIONS ARE IN MILLIMETERS.
 - C. DIMENSIONS AND TOLERANCES PER ASME Y14.5M, 2009

DOCUMENT NUMBER:	98AON13593G	Electronic versions are uncontrolled except when accessed directly from the Document Repository. Printed versions are uncontrolled except when stamped "CONTROLLED COPY" in red.
DESCRIPTION:	UDFN6 1.0X1.0, 0.35P	PAGE 1 OF 1

ON Semiconductor and are trademarks of Semiconductor Components Industries, LLC dba ON Semiconductor or its subsidiaries in the United States and/or other countries. ON Semiconductor reserves the right to make changes without further notice to any products herein. ON Semiconductor makes no warranty, representation or guarantee regarding the suitability of its products for any particular purpose, nor does ON Semiconductor assume any liability arising out of the application or use of any product or circuit, and specifically disclaims any and all liability, including without limitation special, consequential or incidental damages. ON Semiconductor does not convey any license under its patent rights nor the rights of others.

onsemi, **Onsemi**, and other names, marks, and brands are registered and/or common law trademarks of Semiconductor Components Industries, LLC dba "**onsemi**" or its affiliates and/or subsidiaries in the United States and/or other countries. **onsemi** owns the rights to a number of patents, trademarks, copyrights, trade secrets, and other intellectual property. A listing of **onsemi**'s product/patent coverage may be accessed at www.onsemi.com/site/pdf/Patent-Marking.pdf. **onsemi** reserves the right to make changes at any time to any products or information herein, without notice. The information herein is provided "as-is" and **onsemi** makes no warranty, representation or guarantee regarding the accuracy of the information, product features, availability, functionality, or suitability of its products for any particular purpose, nor does **onsemi** assume any liability arising out of the application or use of any product or circuit, and specifically disclaims any and all liability, including without limitation special, consequential or incidental damages. Buyer is responsible for its products and applications using **onsemi** products, including compliance with all laws, regulations and safety requirements or standards, regardless of any support or applications information provided by **onsemi**. "Typical" parameters which may be provided in **onsemi** data sheets and/or specifications can and do vary in different applications and actual performance may vary over time. All operating parameters, including "Typicals" must be validated for each customer application by customer's technical experts. **onsemi** does not convey any license under any of its intellectual property rights nor the rights of others. **onsemi** products are not designed, intended, or authorized for use as a critical component in life support systems or any FDA Class 3 medical devices or medical devices with a same or similar classification in a foreign jurisdiction or any devices intended for implantation in the human body. Should Buyer purchase or use **onsemi** products for any such unintended or unauthorized application, Buyer shall indemnify and hold **onsemi** and its officers, employees, subsidiaries, affiliates, and distributors harmless against all claims, costs, damages, and expenses, and reasonable attorney fees arising out of, directly or indirectly, any claim of personal injury or death associated with such unintended or unauthorized use, even if such claim alleges that **onsemi** was negligent regarding the design or manufacture of the part. **onsemi** is an Equal Opportunity/Affirmative Action Employer. This literature is subject to all applicable copyright laws and is not for resale in any manner.

PUBLICATION ORDERING INFORMATION

LITERATURE FULFILLMENT:

Email Requests to: orderlit@onsemi.com

onsemi Website: www.onsemi.com

TECHNICAL SUPPORT

North American Technical Support:
Voice Mail: 1 800-282-9855 Toll Free USA/Canada
Phone: 011 421 33 790 2910

Europe, Middle East and Africa Technical Support:

Phone: 00421 33 790 2910

For additional information, please contact your local Sales Representative