

**Fast Diode Rectifier Bridge
Power Module**

**$V_{RRM} = 1200V$
 $I_C = 100A @ T_c = 60^\circ C$**

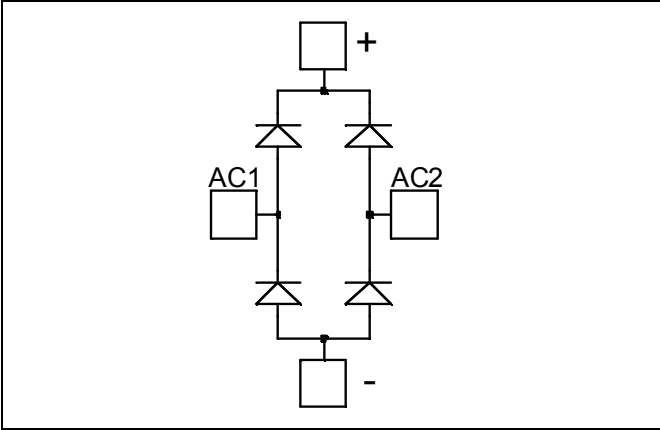

Application

- Uninterruptible Power Supply (UPS)
- Induction heating
- Welding equipment
- High speed rectifiers

Features

- Ultra fast recovery times
- Soft recovery characteristics
- Very low stray inductance
- High blocking voltage
- High current
- Low leakage current
- Very low stray inductance
 - Symmetrical design
 - Lead frames for power connections
- High level of integration

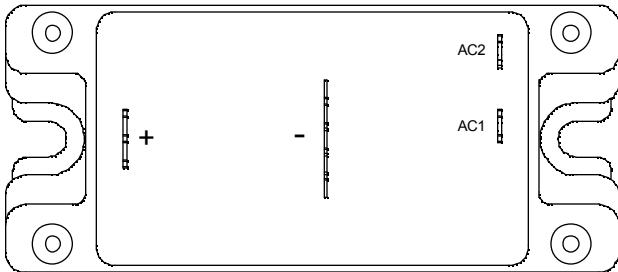

Benefits

- Outstanding performance at high frequency operation
- Low losses
- Low noise switching
- Solderable terminals for easy PCB mounting
- Direct mounting to heatsink (isolated package)
- Low junction to case thermal resistance

Absolute maximum ratings

Symbol	Parameter	Max ratings	Unit		
V_R	Maximum DC reverse Voltage	1200	V		
V_{RRM}	Maximum Peak Repetitive Reverse Voltage				
$I_{F(AV)}$	Maximum Average Forward Current	Duty cycle = 50%	$T_C = 25^\circ C$	120	A
			$T_C = 60^\circ C$	100	
$I_{F(RMS)}$	RMS Forward Current	Duty cycle = 50%	$T_C = 45^\circ C$	135	
I_{FSM}	Non-Repetitive Forward Surge Current	8.3ms	$T_C = 45^\circ C$	500	

CAUTION: These Devices are sensitive to Electrostatic Discharge. Proper Handling Procedures Should Be Followed.

All ratings @ $T_j = 25^\circ\text{C}$ unless otherwise specified

Electrical Characteristics

Symbol	Characteristic	Test Conditions		Min	Typ	Max	Unit
V_F	Diode Forward Voltage	$I_F = 100\text{A}$			2.4	3	V
		$I_F = 150\text{A}$			2.7		
		$I_F = 100\text{A}$	$T_j = 125^\circ\text{C}$		1.8		
I_{RM}	Maximum Reverse Leakage Current	$V_R = 1200\text{V}$	$T_j = 25^\circ\text{C}$			100	μA
			$T_j = 125^\circ\text{C}$			500	
C_T	Junction Capacitance	$V_R = 1200\text{V}$			110		pF

Dynamic Characteristics

Symbol	Characteristic	Test Conditions		Min	Typ	Max	Unit
t_{rr}	Reverse Recovery Time	$I_F = 1\text{A}, V_R = 30\text{V}$ $di/dt = 100\text{A}/\mu\text{s}$	$T_j = 25^\circ\text{C}$		45		ns
t_{rr}	Reverse Recovery Time	$I_F = 100\text{A}$ $V_R = 800\text{V}$ $di/dt = 200\text{A}/\mu\text{s}$	$T_j = 25^\circ\text{C}$		385		ns
			$T_j = 125^\circ\text{C}$		480		
Q_{rr}	Reverse Recovery Charge		$T_j = 25^\circ\text{C}$		1055		nC
			$T_j = 125^\circ\text{C}$		5240		
I_{RRM}	Reverse Recovery Current		$T_j = 25^\circ\text{C}$		6		A
			$T_j = 125^\circ\text{C}$		19		
t_{rr}	Reverse Recovery Time	$I_F = 100\text{A}$ $V_R = 800\text{V}$ $di/dt = 1000\text{A}/\mu\text{s}$	$T_j = 125^\circ\text{C}$		210		ns
Q_{rr}	Reverse Recovery Charge				9.4		μC
I_{RRM}	Reverse Recovery Current				70		A

Thermal and package characteristics

Symbol	Characteristic	Min	Typ	Max	Unit	
R_{thJC}	Junction to Case			0.55	$^\circ\text{C}/\text{W}$	
V_{ISOL}	RMS Isolation Voltage, any terminal to case $t = 1\text{ min}$, $I_{isol} < 1\text{mA}$, 50/60Hz	2500			V	
T_j	Operating junction temperature range	-40		175	$^\circ\text{C}$	
T_{STG}	Storage Temperature Range	-40		125		
T_C	Operating Case Temperature	-40		100		
Torque	Mounting torque	To Heatsink	M5	1.5	4.7	N.m
Wt	Package Weight				160	g

Typical Performance Curve

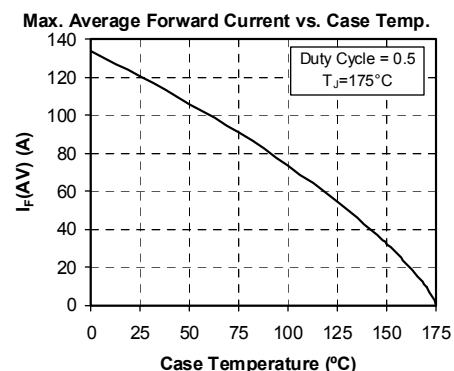
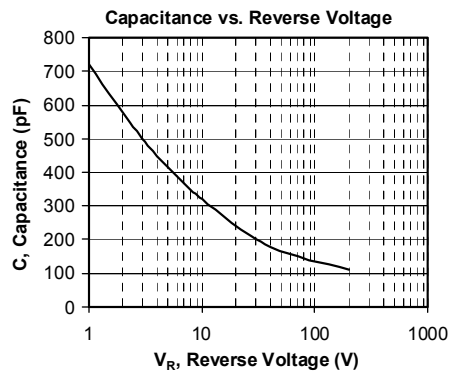
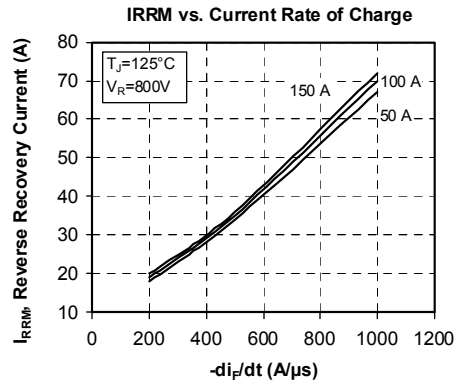
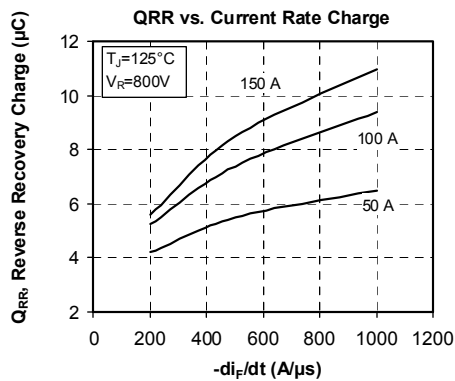
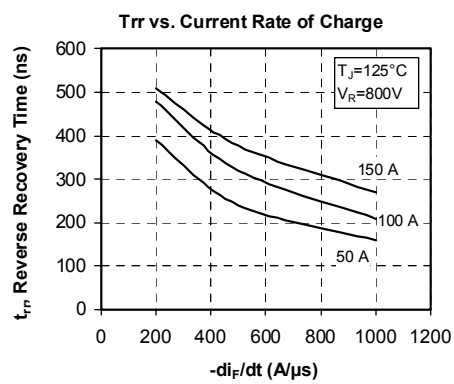
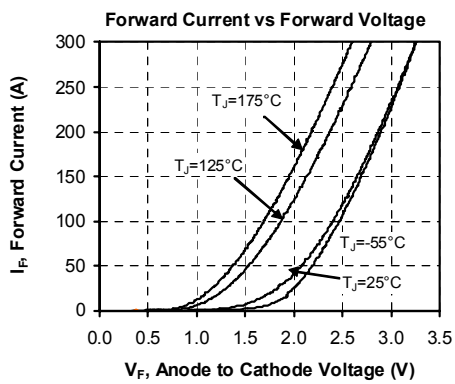
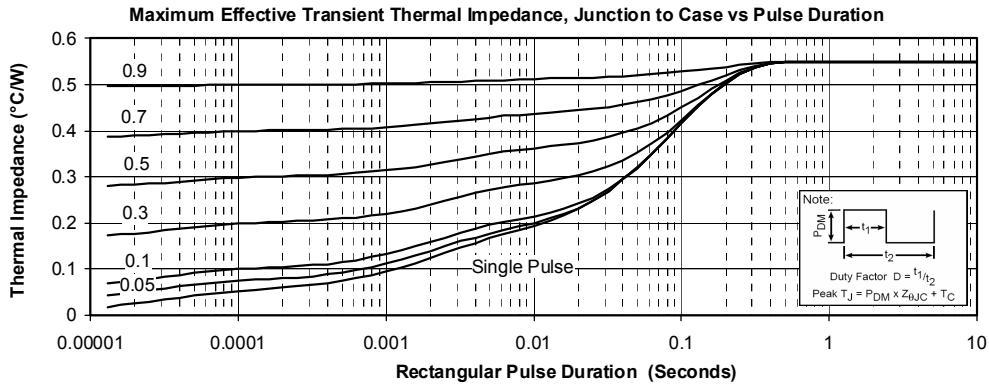

Package outline (dimensions in mm)

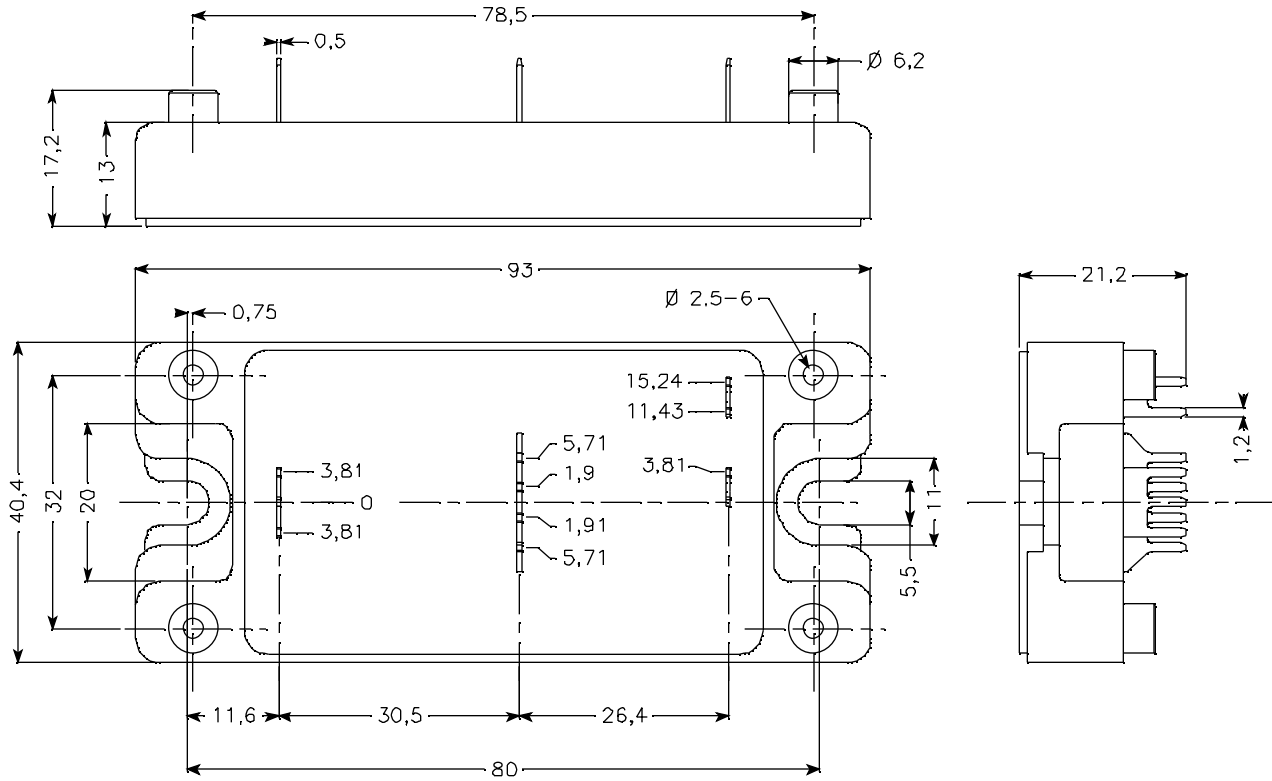

APT reserves the right to change, without notice, the specifications and information contained herein

APT's products are covered by one or more of U.S. patents 4,895,810 5,045,903 5,089,434 5,182,234 5,019,522 5,262,336 6,503,786 5,256,583 4,748,103 5,283,202 5,231,474 5,434,095 5,528,058 and foreign patents. U.S. and Foreign patents pending. All Rights Reserved.