

### Features

- Schottky Barrier Chip
- Guard Ring for Transient Protection
- Low Forward Voltage Drop
- Low Power Loss, High Efficiency
- High Surge Current Capability
- Epoxy Meet UL 94V-0 Classification
- For Use in Low Voltage, High Frequency Inverters, Free Wheeling, and Switching Power Supplies

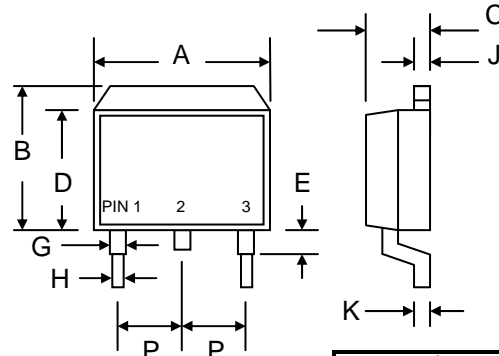

### Mechanical Data

- Case: D<sup>2</sup>PAK/TO-263, Molded Plastic
- Terminals: Plated Leads Solderable per MIL-STD-202, Method 208
- Polarity: See Diagram
- Weight: 1.7 grams (approx.)
- Mounting Position: Any
- Marking: Type Number
- **Lead Free: For RoHS / Lead Free Version, Add "-LF" Suffix to Part Number, See Page 4**

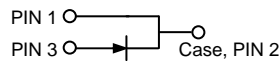

D <sup>2</sup> PAK/TO-263		
Dim	Min	Max
A	9.80	10.40
B	9.60	10.60
C	4.40	4.80
D	8.50	9.10
E	—	2.80
G	1.00	1.40
H	—	0.99
J	1.20	1.40
K	0.30	0.70
P	2.35	2.75
All Dimensions in mm		

### Maximum Ratings and Electrical Characteristics @T<sub>A</sub>=25°C unless otherwise specified

Single Phase, half wave, 60Hz, resistive or inductive load. For capacitive load, derate current by 20%.

Characteristic	Symbol	SB 820D	SB 830D	SB 840D	SB 845D	SB 850D	SB 860D	SB 880D	SB 8100D	Unit
Peak Repetitive Reverse Voltage	V <sub>RRM</sub>	20	30	40	45	50	60	80	100	V
Working Peak Reverse Voltage	V <sub>RWM</sub>									
DC Blocking Voltage	V <sub>R</sub>									
RMS Reverse Voltage	V <sub>R(RMS)</sub>	14	21	28	32	35	42	56	70	V
Average Rectified Output Current @T <sub>C</sub> = 100°C	I <sub>O</sub>	8.0								A
Non-Repetitive Peak Forward Surge Current 8.3ms Single Half Sine-Wave Superimposed on Rated Load (JEDEC Method)	I <sub>FSM</sub>	150								A
Forward Voltage @I <sub>F</sub> = 8.0A	V <sub>FM</sub>	0.55			0.75		0.85			V
Peak Reverse Current @T <sub>J</sub> = 25°C	I <sub>RM</sub>	0.2								mA
At Rated DC Blocking Voltage @T <sub>J</sub> = 100°C		20								
Typical Junction Capacitance (Note 1)	C <sub>J</sub>	450				350				pF
Thermal Resistance Junction to Ambient (Note 2)	R <sub>JA</sub>	73								°C/W
Thermal Resistance Junction to Case (Note 2)	R <sub>JC</sub>	3.0								
Operating and Storage Temperature Range	T <sub>J</sub> , T <sub>STG</sub>	-55 to +150								°C

Note: 1. Measured at 1.0 MHz and applied reverse voltage of 4.0V D.C.  
2. Mounted on FR-4 PCB with minimum recommended pad size.

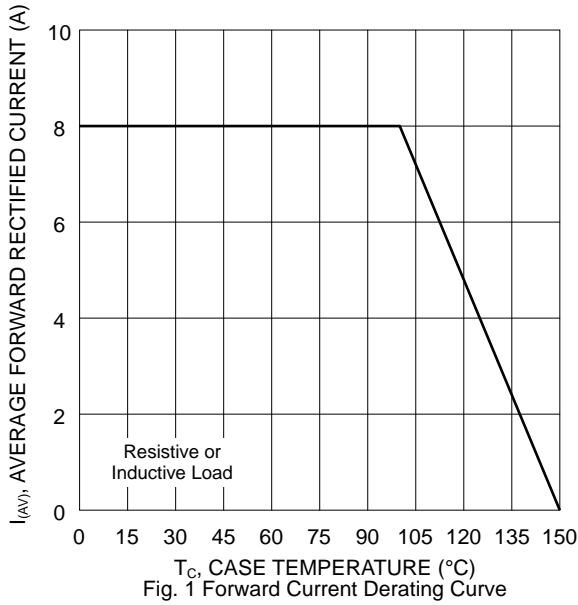

Fig. 1 Forward Current Derating Curve

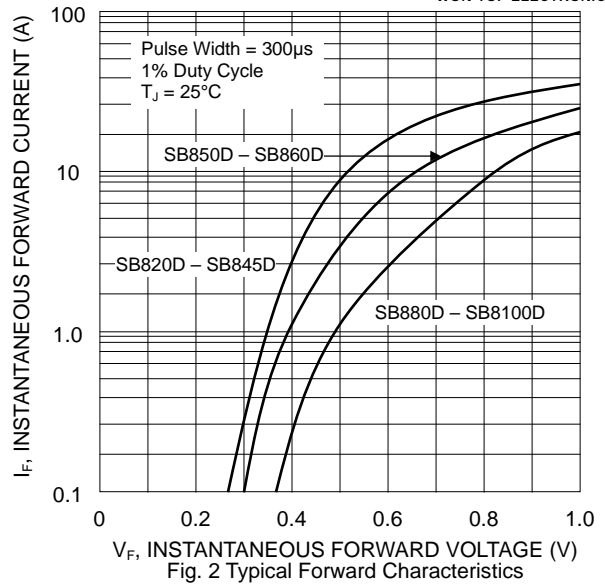

Fig. 2 Typical Forward Characteristics

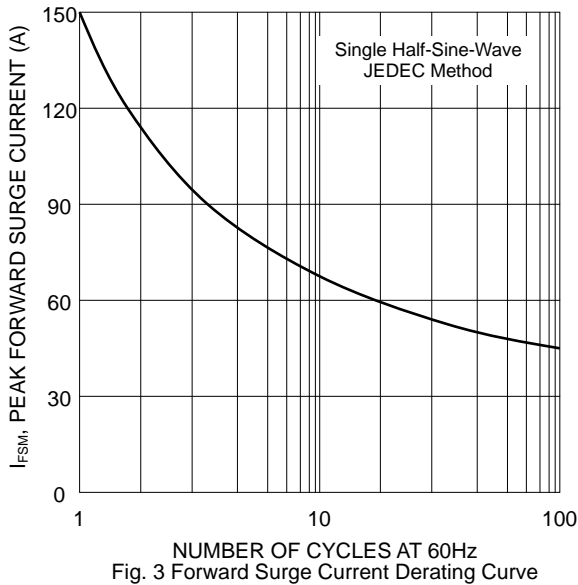

Fig. 3 Forward Surge Current Derating Curve

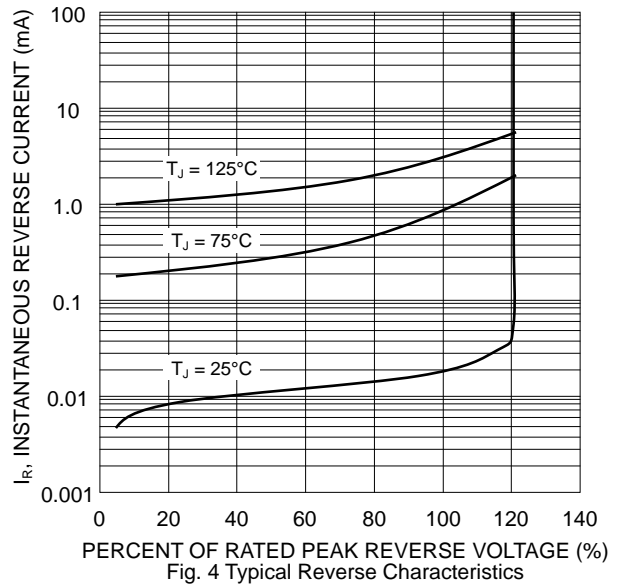

Fig. 4 Typical Reverse Characteristics

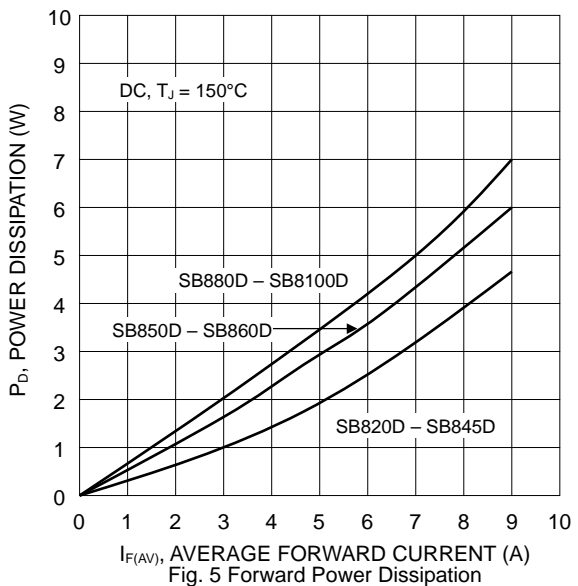

Fig. 5 Forward Power Dissipation

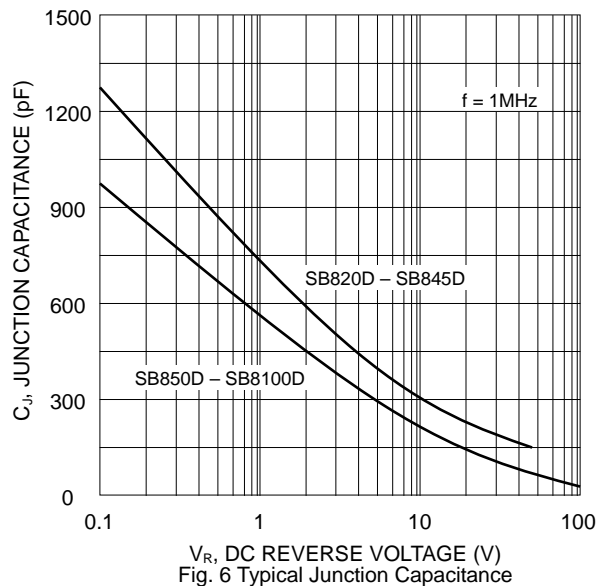
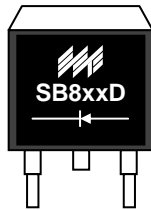

Fig. 6 Typical Junction Capacitance

## MARKING INFORMATION



SB8xxD = Device Number  
 xx = 20, 30, 40, 45, 50, 60, 80 or 100  
 Polarity = As Marked on Body

## RECOMMENDED FOOTPRINT

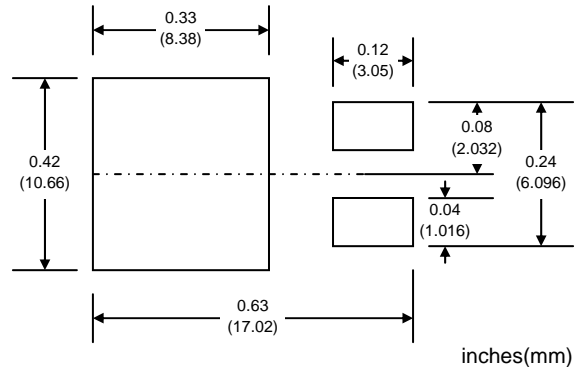

## PACKAGING INFORMATION

### TAPE & REEL

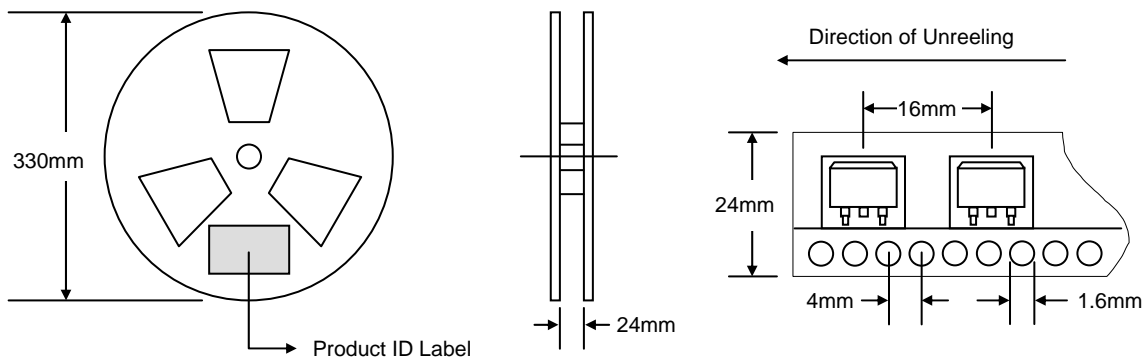

Reel Diameter (mm)	Quantity (PCS)	Inner Box Size L x W x H (mm)	Quantity (PCS)	Carton Size L x W x H (mm)	Quantity (PCS)	Approx. Gross Weight (KG)
330	800	340 x 337 x 45	800	370 x 370 x 420	6,400	15.0

**Note:** 1. Paper reel, white or gray color.  
 2. Components are packed in accordance with EIA standard 481-1 and 481-2.

## ORDERING INFORMATION

Product No.	Package Type	Shipping Quantity
SB820D-T3	D <sup>2</sup> PAK	800/Tape & Reel
SB830D-T3	D <sup>2</sup> PAK	800/Tape & Reel
SB840D-T3	D <sup>2</sup> PAK	800/Tape & Reel
SB845D-T3	D <sup>2</sup> PAK	800/Tape & Reel
SB850D-T3	D <sup>2</sup> PAK	800/Tape & Reel
SB860D-T3	D <sup>2</sup> PAK	800/Tape & Reel
SB880D-T3	D <sup>2</sup> PAK	800/Tape & Reel
SB8100D-T3	D <sup>2</sup> PAK	800/Tape & Reel

1. Shipping quantity given is for minimum packing quantity only. For minimum order quantity, please consult the Sales Department.
2. **To order RoHS / Lead Free version (with Lead Free finish), add "-LF" suffix to part number above. For example, SB820D-T3-LF.**

WON-TOP ELECTRONICS and  are registered trademarks of Won-Top Electronics Co., Ltd (WTE). WTE has checked all information carefully and believes it to be correct and accurate. However, WTE cannot assume any responsibility for inaccuracies. Furthermore, this information does not give the purchaser of semiconductor devices any license under patent rights to manufacturer. WTE reserves the right to change any or all information herein without further notice.

**WARNING:** DO NOT USE IN LIFE SUPPORT EQUIPMENT. WTE power semiconductor products are not authorized for use as critical components in life support devices or systems without the express written approval.

**Won-Top Electronics Co., Ltd.**  
No. 44 Yu Kang North 3rd Road,  
Chine Chen Dist., Kaohsiung 806, Taiwan  
**Phone:** 886-7-822-5408 or 886-7-822-5410  
**Fax:** 886-7-822-5417  
**Email:** sales@wontop.com  
**Internet:** http://www.wontop.com

*We power your everyday.*