

## FUJI POWER MOSFET Super FAP-G Series

## N-CHANNEL SILICON POWER MOSFET

### Features

- High speed switching
- Low on-resistance
- No secondary breakdown
- Low driving power
- Avalanche-proof

### Applications

- Switching regulators
- DC-DC converters
- UPS (Uninterruptible Power Supply)

### Maximum ratings and characteristic Absolute maximum ratings

(Tc=25°C unless otherwise specified)

Item	Symbol	Ratings	Unit	Remarks
Drain-source voltage	V <sub>DS</sub>	500	V	
Continuous drain current	I <sub>D</sub>	±13	A	
Pulsed drain current	I <sub>D</sub> (puls)	±52	A	
Gate-source voltage	V <sub>GS</sub>	±30	V	
Non-Repetitive Maximum avalanche current	I <sub>AS</sub>	13	A	T <sub>ch</sub> ≤ 150°C
Non-Repetitive Maximum avalanche energy	E <sub>AS</sub>	202	mJ	*1
Maximum Drain-Source dV/dt	dV <sub>DS</sub> /dt	20	kV/s	V <sub>DS</sub> ≤ 500V
Peak diode recovery dV/dt	dV/dt	5	kV/μs	*2
Peak diode recovery -di/dt	-di/dt	100	A/μs	*3
Max. power dissipation	P <sub>D</sub>	2.02	W	T <sub>a</sub> =25°C
		195		T <sub>c</sub> =25°C
Operating and storage temperature range	T <sub>ch</sub>	+150	°C	
	T <sub>stg</sub>	-55 to +150	°C	

\*1 L=2.20mH, V<sub>CC</sub>=50V, Starting T<sub>ch</sub>=25°C, See to Avalanche Energy Graph

\*2 I<sub>F</sub> ≤ -I<sub>D</sub>, -di/dt=100A/μs, V<sub>CC</sub> ≤ BV<sub>DSS</sub>, T<sub>ch</sub> ≤ 150°C

\*3 I<sub>F</sub> ≤ -I<sub>D</sub>, dV/dt=5kV/μs, V<sub>CC</sub> ≤ BV<sub>DSS</sub>, T<sub>ch</sub> ≤ 150°C

### Electrical characteristics (T<sub>c</sub> =25°C unless otherwise specified)

Item	Symbol	Test Conditions	Min.	Typ.	Max.	Units
Drain-source breakdown voltage	V <sub>(BR)DSS</sub>	I <sub>D</sub> = 250μA V <sub>GS</sub> =0V	500			V
Gate threshold voltage	V <sub>GS(th)</sub>	I <sub>D</sub> = 250μA V <sub>DS</sub> =V <sub>GS</sub>	3.0		5.0	V
Zero gate voltage drain current	I <sub>DSS</sub>	V <sub>DS</sub> =500V V <sub>GS</sub> =0V T <sub>ch</sub> =25°C		10	25	μA
		V <sub>DS</sub> =400V V <sub>GS</sub> =0V T <sub>ch</sub> =125°C		1.0	2	mA
Gate-source leakage current	I <sub>GSS</sub>	V <sub>GS</sub> =±30V V <sub>DS</sub> =0V		10	100	nA
Drain-source on-state resistance	R <sub>DS(on)</sub>	I <sub>D</sub> =6.5A V <sub>GS</sub> =10V		0.42	0.55	Ω
Forward transconductance	g <sub>fs</sub>	I <sub>D</sub> =6.5A V <sub>DS</sub> =25V	5.5	11		S
Input capacitance	C <sub>iss</sub>	V <sub>DS</sub> =25V		1100	1650	pF
Output capacitance	C <sub>oss</sub>	V <sub>GS</sub> =0V		165	250	pF
Reverse transfer capacitance	C <sub>rss</sub>	f=1MHz		9	13.5	pF
Turn-on time t <sub>on</sub>	td(on)	V <sub>CC</sub> =300V I <sub>D</sub> =6.5A		23	35	ns
	t <sub>r</sub>	V <sub>GS</sub> =10V		6.5	11	
Turn-off time t <sub>off</sub>	td(off)	R <sub>GS</sub> =10Ω		47	71	ns
	t <sub>f</sub>			7.5	12	
Total Gate Charge	Q <sub>G</sub>	V <sub>CC</sub> =250V		28	42	nC
Gate-Source Charge	Q <sub>GS</sub>	I <sub>D</sub> =13A		10	15	
Gate-Drain Charge	Q <sub>GD</sub>	V <sub>GS</sub> =10V		9	14	
Avalanche capability	I <sub>AV</sub>	L=2.20mH T <sub>ch</sub> =25°C	13			A
Diode forward on-voltage	V <sub>SD</sub>	I <sub>F</sub> =13A V <sub>GS</sub> =0V T <sub>ch</sub> =25°C		1.20	1.80	V
Reverse recovery time	t <sub>rr</sub>	I <sub>F</sub> =13A V <sub>GS</sub> =0V		120	250	ns
Reverse recovery charge	Q <sub>rr</sub>	-di/dt=100A/μs T <sub>ch</sub> =25°C		0.5	1.2	μC

### Thermal characteristics

Item	Symbol	Test Conditions	Min.	Typ.	Max.	Units
Thermal resistance	R <sub>th(ch-c)</sub>	channel to case			0.64	°C/W
	R <sub>th(ch-a)</sub>	channel to ambient			62.0	°C/W

### Outline Drawings [mm]

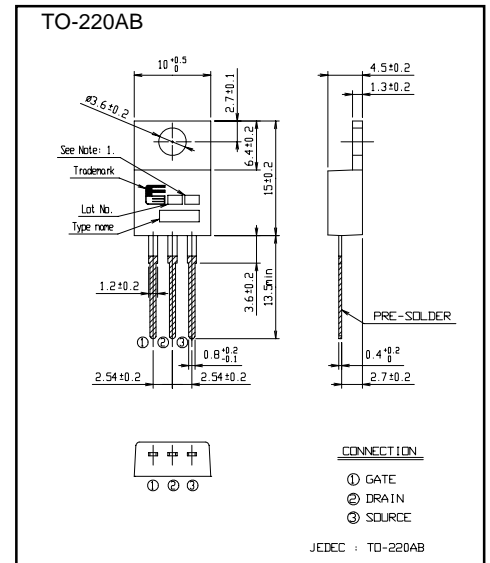

### Equivalent circuit schematic

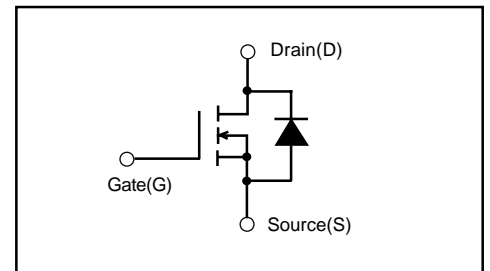

Characteristics

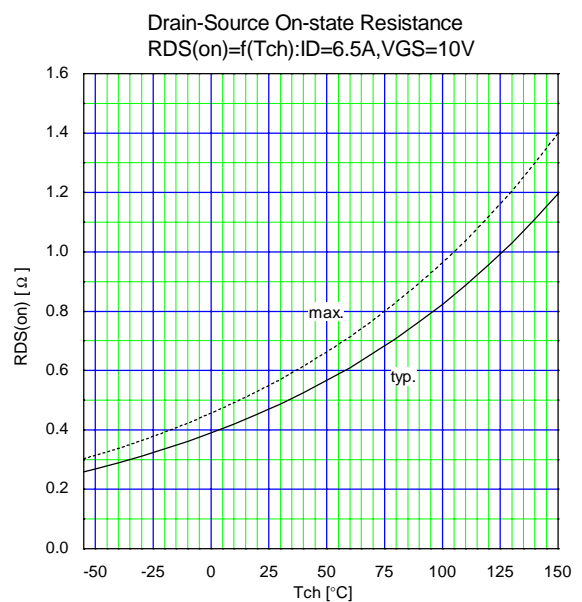
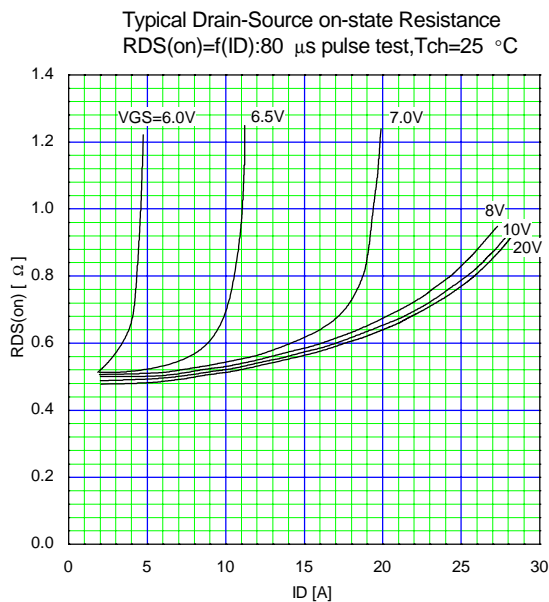
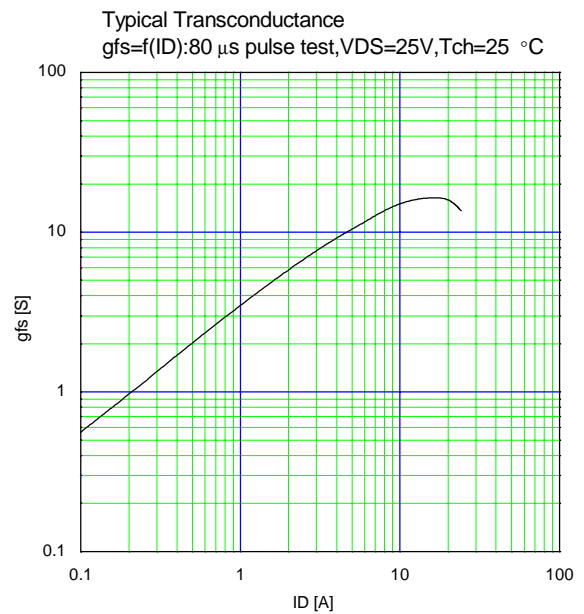
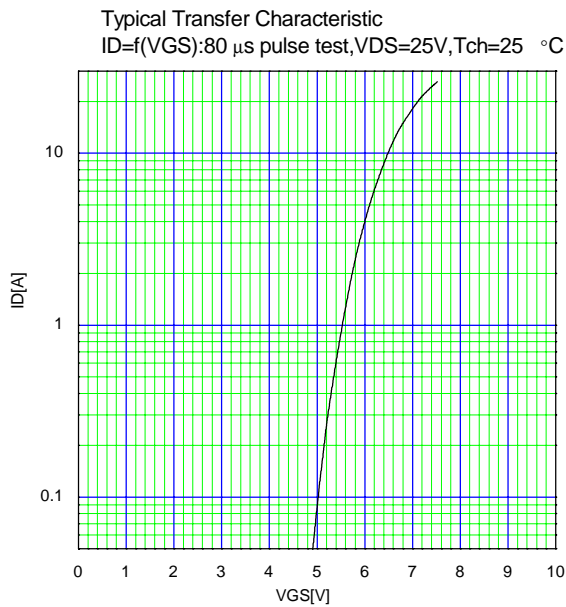
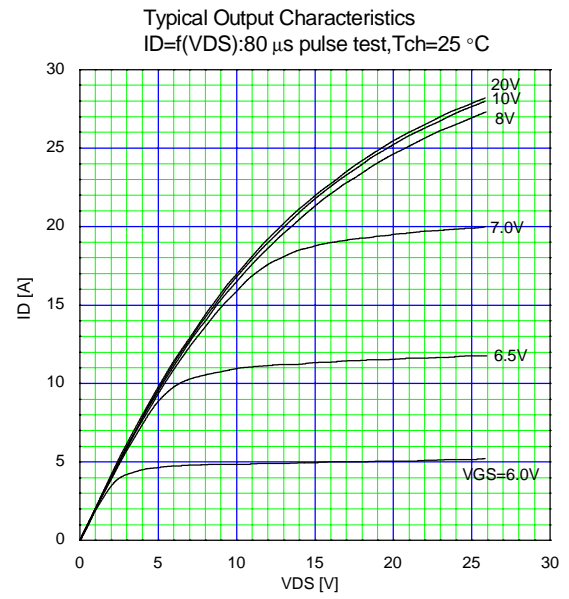
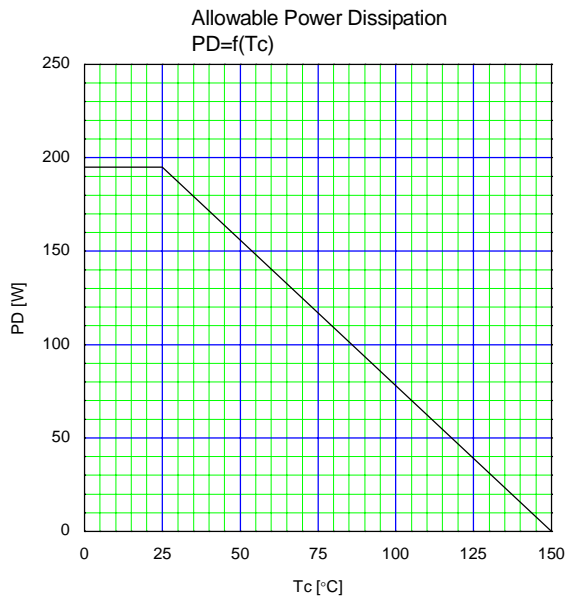

Gate Threshold Voltage vs. T<sub>ch</sub>  
 $V_{GS(th)} = f(T_{ch}) : V_{DS} = V_{GS}, I_D = 250\mu A$

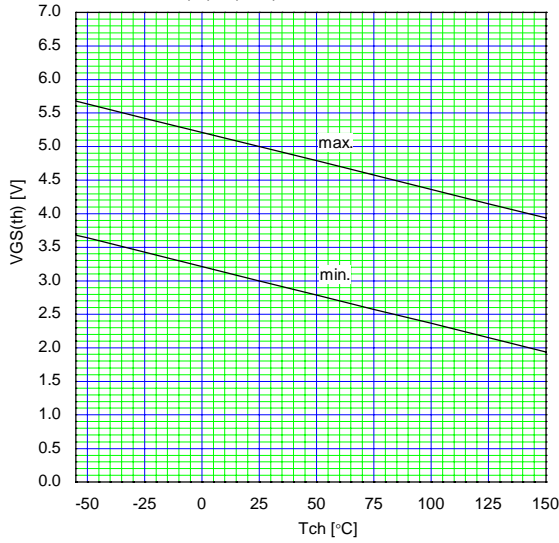

Typical Gate Charge Characteristics  
 $V_{GS} = f(Q_g) : I_D = 13A, T_{ch} = 25^\circ C$

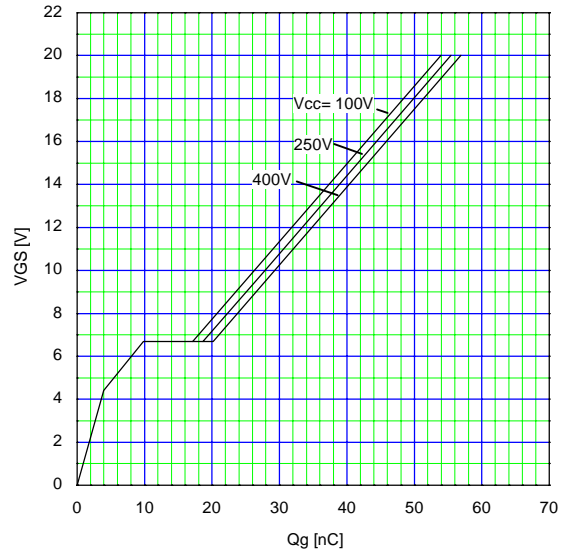

Typical Capacitance  
 $C = f(V_{DS}) : V_{GS} = 0V, f = 1MHz$

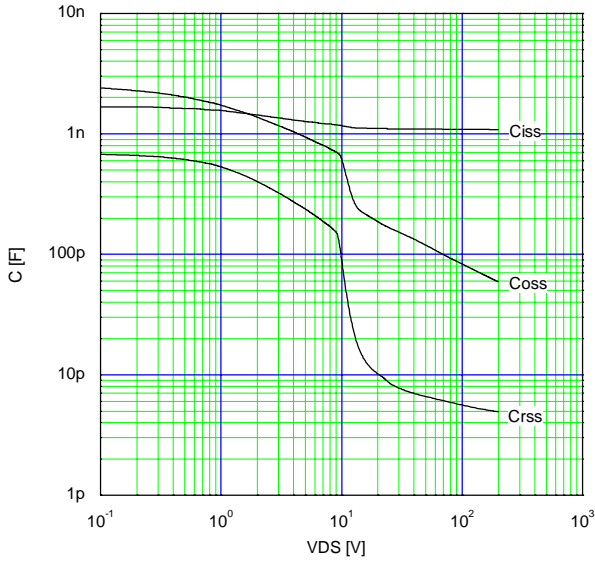

Typical Forward Characteristics of Reverse Diode  
 $I_F = f(V_{SD}) : 80\mu s \text{ pulse test}, T_{ch} = 25^\circ C$

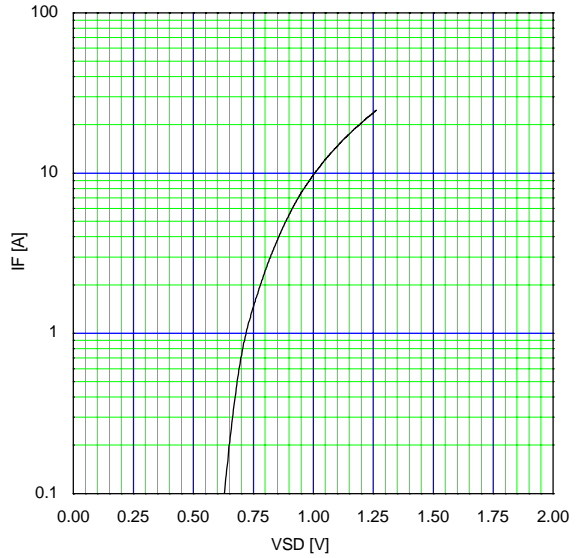

Typical Switching Characteristics vs. I<sub>D</sub>  
 $t = f(I_D) : V_{cc} = 300V, V_{GS} = 10V, R_G = 10\ \Omega$

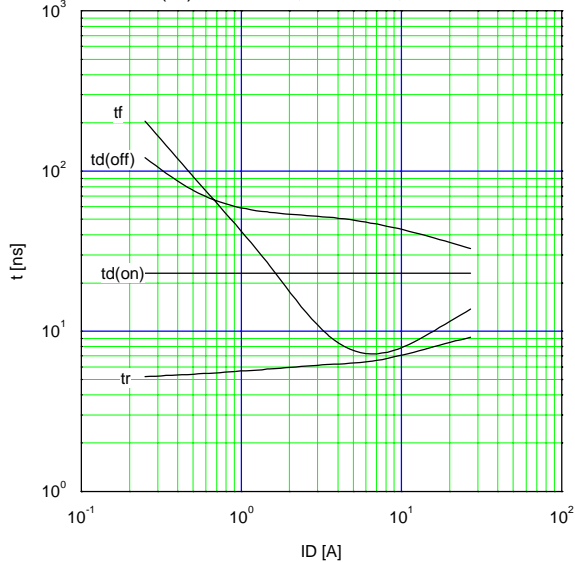

Maximum Avalanche Energy vs. starting T<sub>ch</sub>  
 $E_{AS} = f(\text{starting } T_{ch}) : V_{cc} = 50V$

