

DATA SHEET

**ELECTROSTATIC DISCHARGE
PROTECTION DEVICES**

INDUSTRIAL / CONSUMER

UAD8C05L01 series

RoHS compliant & Halogen free



Product specification— November 14, 2020 V.1

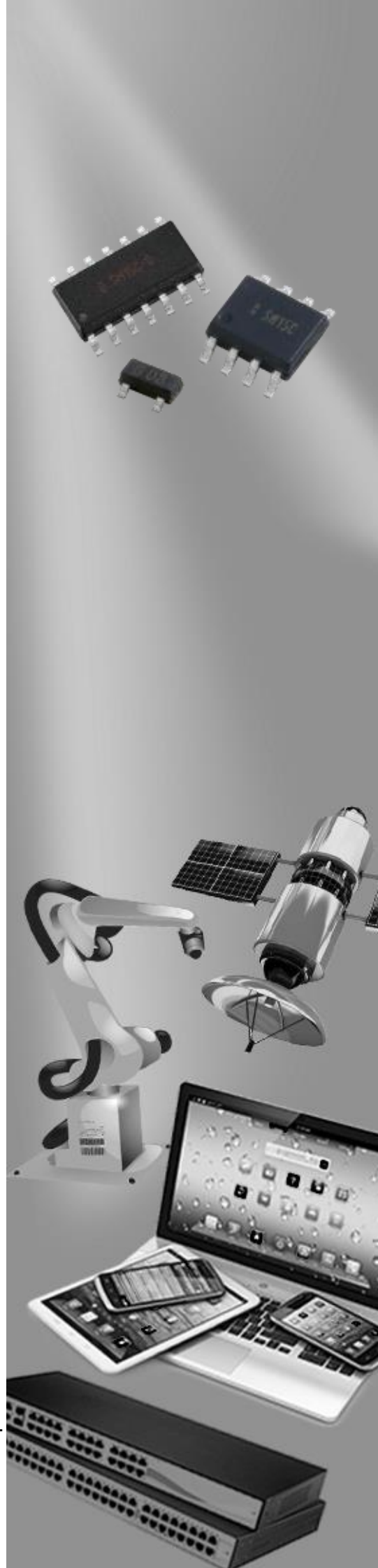

ElectroStatic Discharged Protection Devices (ESD) Data Sheet

Description

The UAD8C05L01 includes back-to-back TVS diodes fabricated in a proprietary silicon avalanche technology to provide protection for electronic equipment that may experience destructive electrostatic discharge (ESD). These robust diodes can safely absorb repetitive ESD strikes up to the maximum level specified in the IEC61000-4-2 international standard without performance degradation.

The back-to-back configuration provides symmetrical ESD protection for data lines when AC signals are present.



Contact : ±8kV
Air : ±15kV



Features

- IEC61000-4-2 ESD 20KV Air, 20KV contact compliance
- SOD882 surface mount package
- Working voltage: 5V
- Low leakage current
- Low operating and clamping voltages
- Lead Free/RoHS compliant
- Flammability rating UL 94V-0
- Meets MSL level 1, per J-STD-020
- Marking: B1

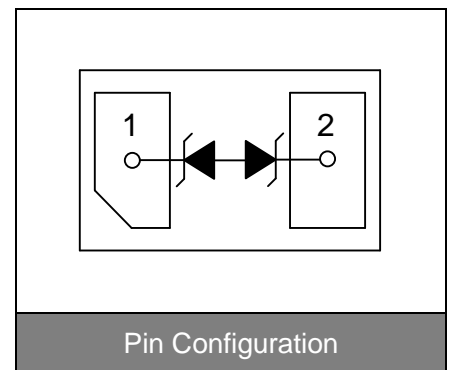

Applications

- USB 3.0/USB 2.0
- MHL/MIPI/MDDI
- HDMI, Video Port, eSATA
- Set Top Boxes, Game Consoles
- Smart Phones
- External Storage
- Ultrabooks, Notebooks
- Tablets, eReaders

Maximum Ratings

Rating	Symbol	Value	Unit
Peak pulse current (tp=8/20µs)	I _{PP}	3	A
ESD voltage (Contact discharge)	V _{ESD}	±8	kV
ESD voltage (Air discharge)		±15	
Storage & operating temperature range	T _{STG} ,T _J	-55~+150	°C

Electrical Characteristics (T_J=25°C)

Parameter	Symbol	Condition	Min.	Typ.	Max.	Unit
Reverse stand-off voltage	V _{RWM}				5	V
Reverse breakdown voltage	V _{BR}	I _{BR} =1mA	7			V
Reverse leakage current	I _R	V _R =5V			<u>1</u>	μA
Clamping voltage (tp=8/20μs)	V _C	I _{PP} =1A		<u>13</u>		V
Clamping voltage (tp=8/20μs)	V _C	I _{PP} = <u>3A</u>		<u>20</u>		V
Off state junction capacitance	C _J	0Vdc,f=1MHz		0.4		pF

Typical Characteristics Curves

Figure 1. Capacitance vs. Bias Voltage

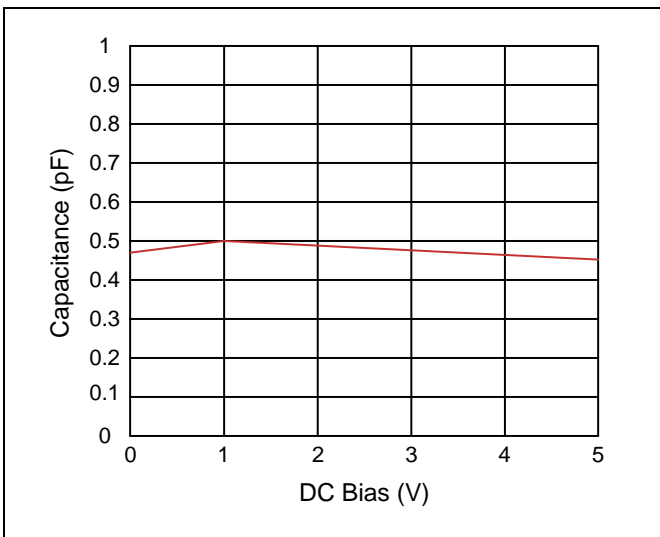

Figure 2. Insertion Loss (S21) I/O to GND

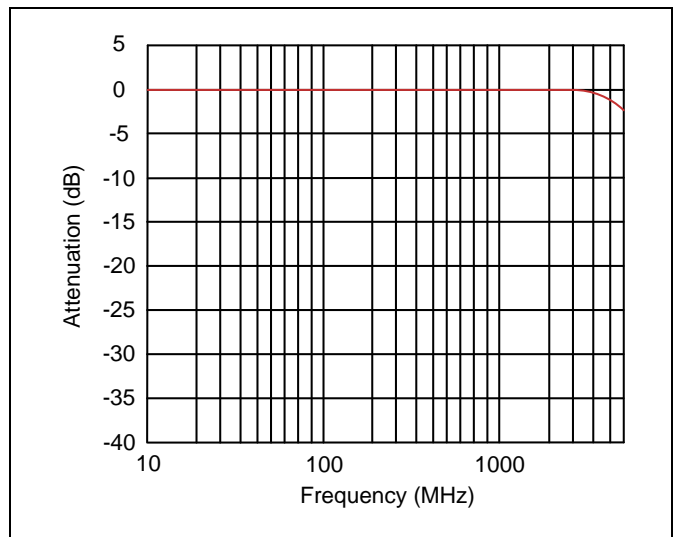

Figure 3. Pulse Waveform

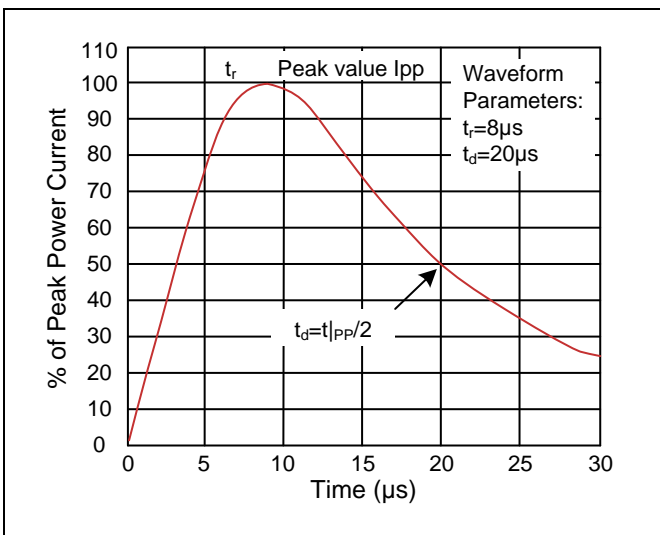
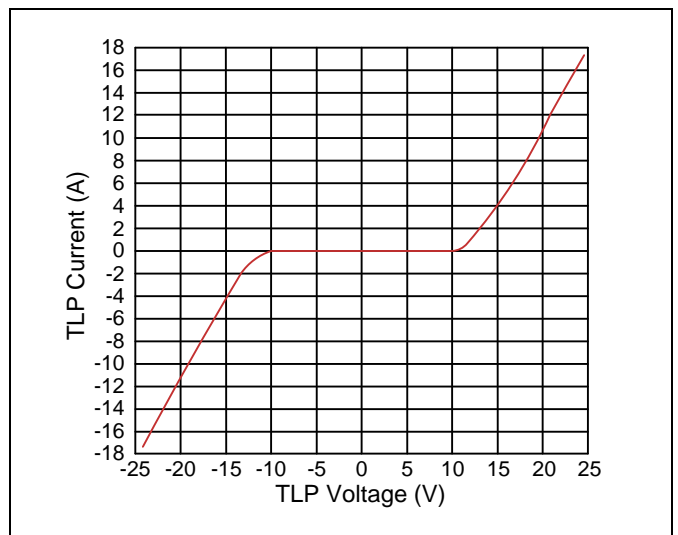
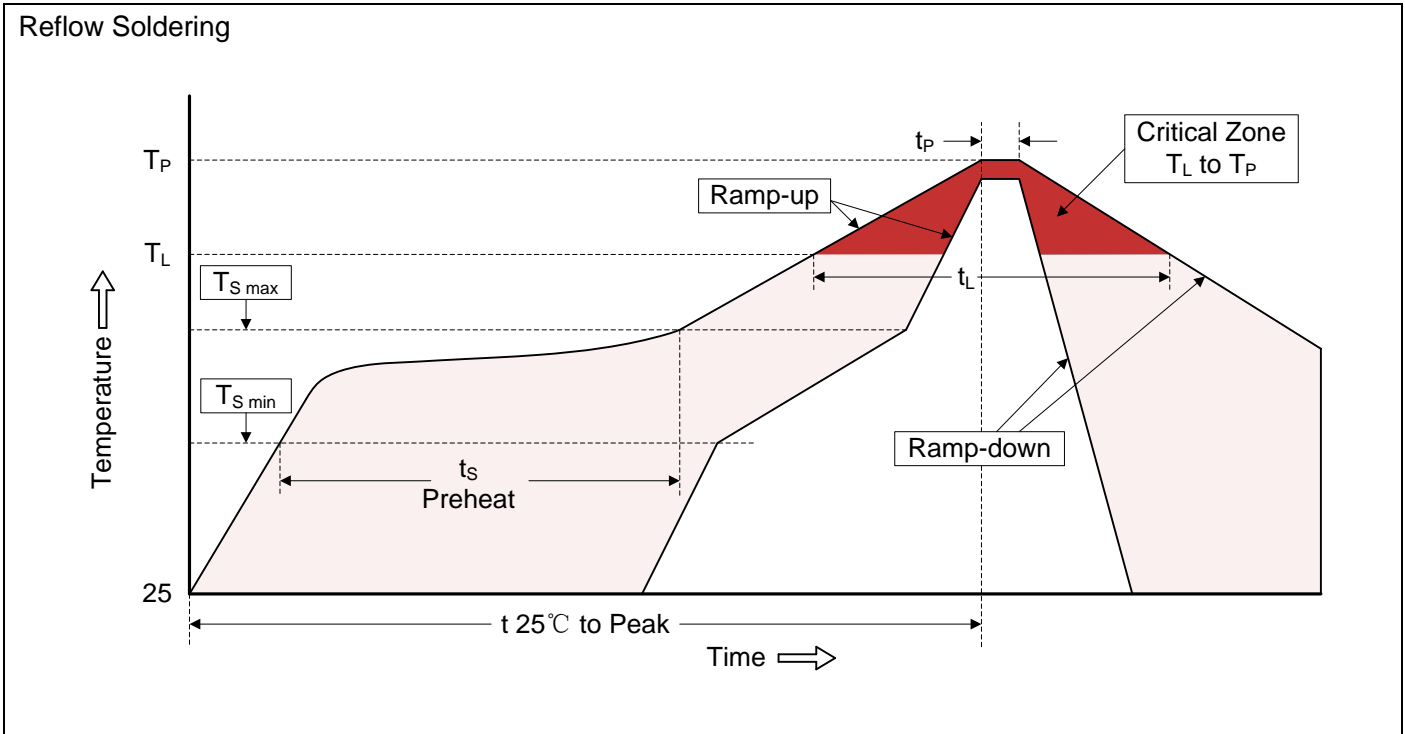

Figure 4. Transmission Line Pulsing (TLP) Plot



Recommended Soldering Conditions



Recommended Conditions

Profile Feature	Pb-Free Assembly
Average ramp-up rate (T_L to T_P)	3°C/second max.
Preheat -Temperature Min ($T_{S\ min}$) -Temperature Max ($T_{S\ max}$) -Time (min to max) (t_s)	150°C 200°C 60-180 seconds
$T_{S\ max}$ to T_L -Ramp-up Rate	3°C/second max.
Time maintained above: -Temperature (T_L) -Time (t_L)	217°C 60-150 seconds
Peak Temperature (T_P)	260°C
Time within 5°C of actual Peak Temperature (t_P)	20-40 seconds
Ramp-down Rate	6°C/second max.
Time 25°C to Peak Temperature	8 minutes max.

Dimensions (SOD882)

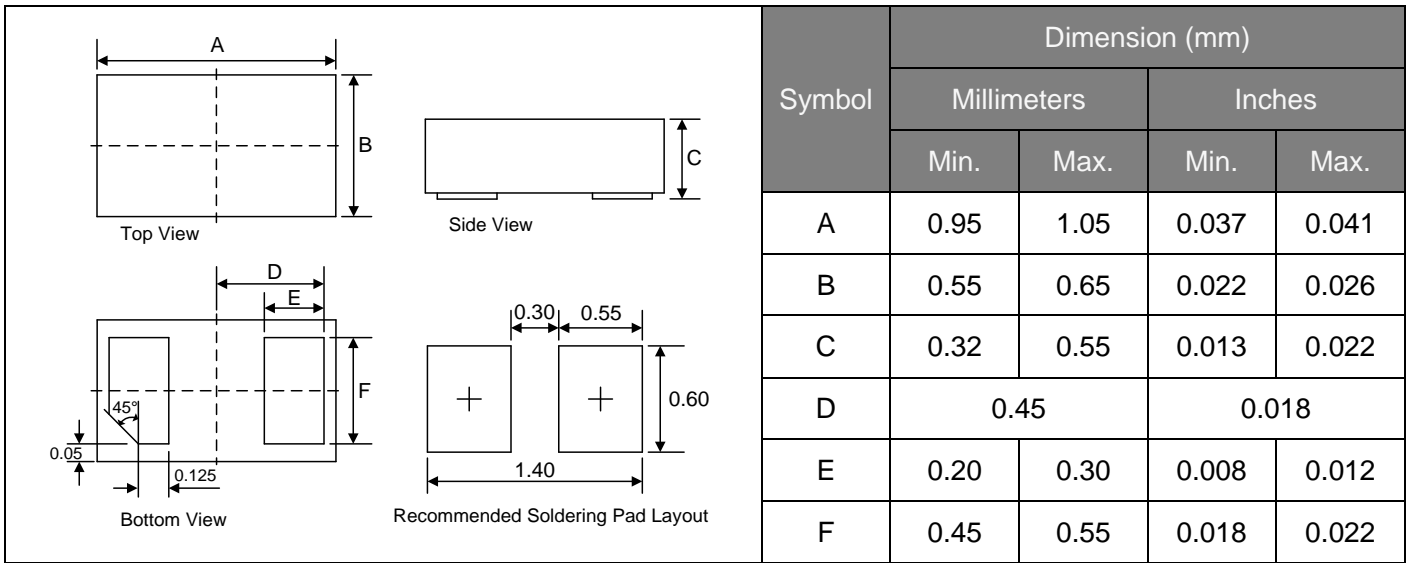

Packaging

