

Boost Converter Stage in APM16 Series for Multiphase and Semi-Bridgeless PFC with SiC Diodes



ON Semiconductor®

www.onsemi.com

FAM65CR51ADZ1, FAM65CR51ADZ2

Features

- Integrated SIP or DIP Boost Converter Stage Power Module for On-board Charger (OBC) in EV or PHEV
- 5 kV/1 sec Electrically Isolated Substrate for Easy Assembly
- Creepage and Clearance per IEC60664-1, IEC 60950-1
- Compact Design for Low Total Module Resistance
- Module Serialization for Full Traceability
- Lead Free, RoHS and UL94V-0 Compliant
- Automotive Qualified per AEC Q101 and AQC324 Guidelines
- Improved Performance with SiC Diodes

Applications

- PFC Stage of an On-board Charger in PHEV or EV

Benefits

- Enable Design of Small, Efficient and Reliable System for Reduced Vehicle Fuel Consumption and CO₂ Emission
- Simplified Assembly, Optimized Layout, High Level of Integration, and Improved Thermal Performance

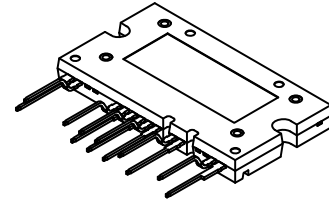

APMCD-A16
12 LEAD
CASE MODGG

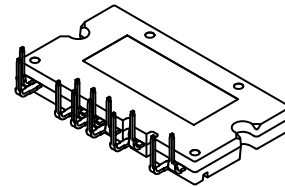

APMCD-B16
12 LEAD
CASE MODGK

MARKING DIAGRAM

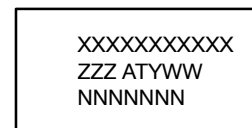

XXXX = Specific Device Code
ZZZ = Lot ID
AT = Assembly & Test Location
Y = Year
W = Work Week
NNN = Serial Number

ORDERING INFORMATION

See detailed ordering, marking and shipping information on page 2 of this data sheet.

FAM65CR51ADZ1, FAM65CR51ADZ2

ORDERING INFORMATION

Part Number	Package	Lead Forming	DBC Material	Pb-Free and RoHS Compliant	Operating Temperature (T _A)	Packing Method
FAM65CR51ADZ1	APM16-CDA	Y-Shape	Al ₂ O ₃	Yes	-40°C ~ 125°C	Tube
FAM65CR51ADZ2	APM16-CDB	L-Shape	Al ₂ O ₃	Yes	-40°C ~ 125°C	Tube

Pin Configuration and Description

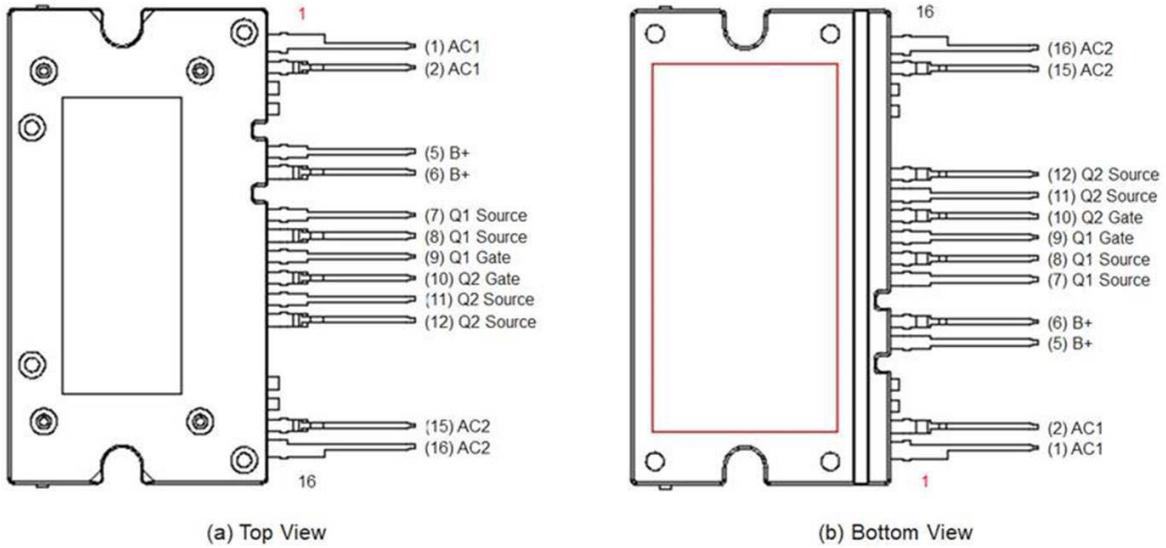

Figure 1. Pin Configuration

Table 1. PIN DESCRIPTION

Pin Number	Pin Name	Pin Description
1, 2	AC1	Phase 1 Leg of the PFC Bridge
3	NC	Not Connected
4	NC	Not Connected
5, 6	B+	Positive Battery Terminal
7, 8	Q1 Source	Source Terminal of Q1
9	Q1 Gate	Gate Terminal of Q1
10	Q2 Gate	Gate Terminal of Q2
11, 12	Q2 Source	Source Terminal of Q2
13	NC	Not Connected
14	NC	Not Connected
15, 16	AC2	Phase 2 Leg of the PFC Bridge

FAM65CR51ADZ1, FAM65CR51ADZ2

INTERNAL EQUIVALENT CIRCUIT

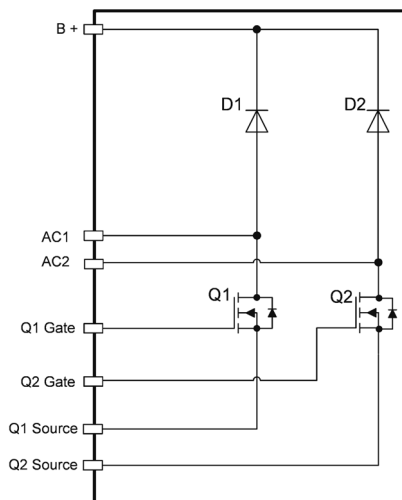

Figure 2. Internal Block Diagram

Table 2. ABSOLUTE MAXIMUM RATINGS OF MOSFET ($T_J = 25^\circ\text{C}$, Unless Otherwise Specified)

Symbol	Parameter	Max	Unit
V_{DS} (Q1~Q2)	Drain-to-Source Voltage	650	V
V_{GS} (Q1~Q2)	Gate-to-Source Voltage	± 20	V
I_D (Q1~Q2)	Drain Current Continuous ($T_C = 25^\circ\text{C}$, $V_{GS} = 10\text{ V}$) (Note 1)	41	A
	Drain Current Continuous ($T_C = 100^\circ\text{C}$, $V_{GS} = 10\text{ V}$) (Note 1)	25	A
E_{AS} (Q1~Q2)	Single Pulse Avalanche Energy (Note 2)	623	mJ
P_D	Power Dissipation (Note 1)	189	W
T_J	Maximum Junction Temperature	-55 to $+150$	$^\circ\text{C}$
T_C	Maximum Case Temperature	-40 to $+125$	$^\circ\text{C}$
T_{STG}	Storage Temperature	-40 to $+125$	$^\circ\text{C}$

Stresses exceeding those listed in the Maximum Ratings table may damage the device. If any of these limits are exceeded, device functionality should not be assumed, damage may occur and reliability may be affected.

1. Maximum continuous current and power, without switching losses, to reach $T_J = 150^\circ\text{C}$ respectively at $T_C = 25^\circ\text{C}$ and $T_C = 100^\circ\text{C}$; defined by design based on MOSFET $R_{DS(ON)}$ and $R_{\theta JC}$ and not subject to production test
2. Starting $T_J = 25^\circ\text{C}$, $I_{AS} = 6.5\text{ A}$, $R_G = 25\ \Omega$

DBC Substrate

0.63 mm Al₂O₃ alumina with 0.3 mm copper on both sides.
DBC substrate is NOT nickel plated.

Lead Frame

OFC copper alloy, 0.50 mm thick. Plated with 8 μm to 25.4 μm thick Matte Tin

Flammability Information

All materials present in the power module meet UL flammability rating class 94V-0.

Compliance to RoHS Directives

The power module is 100% lead free and RoHS compliant 2000/53/C directive.

Solder

Solder used is a lead free SnAgCu alloy.

Solder presents high risk to melt at temperature beyond 210 $^\circ\text{C}$. Base of the leads, at the interface with the package body, should not be exposed to more than 200 $^\circ\text{C}$ during mounting on the PCB or during welding to prevent the re-melting of the solder joints.

FAM65CR51ADZ1, FAM65CR51ADZ2

Table 3. ELECTRICAL SPECIFICATIONS OF MOSFET ($T_J = 25^\circ\text{C}$, Unless Otherwise Specified)

Symbol	Parameter	Conditions	Min	Typ	Max	Unit
BV_{DSS}	Drain-to-Source Breakdown Voltage	$I_D = 1\text{ mA}, V_{GS} = 0\text{ V}$	650	–	–	V
$V_{GS(th)}$	Gate-to-Source Threshold Voltage	$V_{GS} = V_{DS}, I_D = 3.3\text{ mA}$	3.0	–	5.0	V
$R_{DS(ON)} Q1$	Q1 Low Side MOSFET	$V_{GS} = 10\text{ V}, I_D = 20\text{ A}$	–	44	51	$\text{m}\Omega$
$R_{DS(ON)} Q2$	Q2 Low Side MOSFET		–	44	51	$\text{m}\Omega$
$R_{DS(ON)} Q1$	Q1 Low Side MOSFET	$V_{GS} = 10\text{ V}, I_D = 20\text{ A}, T_J = 125^\circ\text{C}$ (Note 3)	–	79	–	$\text{m}\Omega$
$R_{DS(ON)} Q2$	Q2 Low Side MOSFET		–	79	–	$\text{m}\Omega$
g_{FS}	Forward Transconductance	$V_{DS} = 20\text{ V}, I_D = 20\text{ A}$ (Note 3)	–	30	–	S
I_{GSS}	Gate-to-Source Leakage Current	$V_{GS} = \pm 20\text{ V}, V_{DS} = 0\text{ V}$	–100	–	+100	nA
I_{DSS}	Drain-to-Source Leakage Current	$V_{DS} = 650\text{ V}, V_{GS} = 0\text{ V}$	–	–	10	μA

DYNAMIC CHARACTERISTICS (Note 3)

C_{iss}	Input Capacitance	$V_{DS} = 400\text{ V}$ $V_{GS} = 0\text{ V}$ $f = 1\text{ MHz}$	–	4864	–	pF
C_{oss}	Output Capacitance		–	109	–	pF
C_{rss}	Reverse Transfer Capacitance		–	16	–	pF
$C_{oss(eff)}$	Effective Output Capacitance	$V_{DS} = 0\text{ to }520\text{ V}$ $V_{GS} = 0\text{ V}$	–	652	–	pF
R_g	Gate Resistance	$f = 1\text{ MHz}$	–	2	–	Ω
$Q_{g(tot)}$	Total Gate Charge	$V_{DS} = 380\text{ V}$ $I_D = 20\text{ A}$ $V_{GS} = 0\text{ to }10\text{ V}$	–	123	–	nC
Q_{gs}	Gate-to-Source Gate Charge		–	37.5	–	nC
Q_{gd}	Gate-to-Drain "Miller" Charge		–	49	–	nC

SWITCHING CHARACTERISTICS (Note 3)

t_{on}	Turn-on Time	$V_{DS} = 400\text{ V}$ $I_D = 20\text{ A}$ $V_{GS} = 10\text{ V}$ $R_G = 4.7\text{ Ohm}$	–	87	–	ns
$t_{d(on)}$	Turn-on Delay Time		–	47	–	ns
t_r	Turn-on Rise Time		–	43	–	ns
t_{off}	Turn-off Time		–	146	–	ns
$t_{d(off)}$	Turn-off Delay Time		–	118	–	ns
t_f	Turn-off Fall Time		–	29	–	ns

BODY DIODE CHARACTERISTICS

V_{SD}	Source-to-Drain Diode Voltage	$I_{SD} = 20\text{ A}, V_{GS} = 0\text{ V}$	–	0.95	–	V
T_{rr}	Reverse Recovery Time	$V_{DS} = 520\text{ V}, I_D = 20\text{ A},$ $dI/dt = 100\text{ A}/\mu\text{s}$ (Note 3)	–	133	–	ns
Q_{rr}	Reverse Recovery Charge		–	669	–	nC

Product parametric performance is indicated in the Electrical Characteristics for the listed test conditions, unless otherwise noted. Product performance may not be indicated by the Electrical Characteristics if operated under different conditions.

3. Defined by design, not subject to production test

FAM65CR51ADZ1, FAM65CR51ADZ2

Table 4. ABSOLUTE MAXIMUM RATINGS OF THE BOOST DIODE ($T_J = 25^\circ\text{C}$, Unless Otherwise Specified)

Symbol	Parameter	Rating	Unit
V_{RRM}	Peak Repetitive Reverse Voltage (Note 4)	650	V
E_{AS}	Avalanche Energy (17 A, 1 mH)	144	mJ
I_F	Continuous Rectified Forward Current, $T_C < 148^\circ\text{C}$	30	A
$I_{F,MAX}$	Non-Repetitive Forward Surge Current, $T_C = 25^\circ\text{C}$, 10 μs	1100	A
$I_{F,MAX}$	Non-Repetitive Forward Surge Current, $T_C = 150^\circ\text{C}$, 10 μs	1000	A
I_{FSM}	Non-Repetitive Peak Surge Current (Sine Half Wave, $T_p = 8.3$ ms)	110	A
P_D	Power Dissipation ($T_C = 25^\circ\text{C}$)	65	W
T_J	Maximum Junction Temperature	-55 to +175	$^\circ\text{C}$
T_C	Maximum Case Temperature	-40 to +125	$^\circ\text{C}$
T_{STG}	Storage Temperature	-40 to +125	$^\circ\text{C}$

4. V_{RRM} and I_F value referenced to TO220-2L Auto Qualified Package Device FFSP3065B_F085

Table 5. ELECTRICAL SPECIFICATIONS OF THE BOOST DIODE ($T_J = 25^\circ\text{C}$, Unless Otherwise Specified)

Symbol	Parameter	Test Conditions		Min	Typ	Max	Unit
V_{DC}	DC Blocking Voltage	$I_R = 200 \mu\text{A}$	$T_C = 25^\circ\text{C}$	650	-	-	V
V_F	Instantaneous Forward Voltage	$I_F = 30$ A	$T_C = 25^\circ\text{C}$	-	1.38	1.7	V
			$T_C = 125^\circ\text{C}$	-	1.6	2.0	V
			$T_C = 175^\circ\text{C}$	-	1.72	2.4	V
I_R	Instantaneous Reverse Current	$V_R = 650$ V	$T_C = 25^\circ\text{C}$	-	0.5	40	μA
			$T_C = 125^\circ\text{C}$	-	1.0	80	μA
			$T_C = 175^\circ\text{C}$	-	2.0	160	μA
Q_C	Total Capacitive Charge	$V_R = 400$ V	$T_C = 25^\circ\text{C}$	-	43	-	nC
C	Total Capacitance	$V_R = 1$ V	$f = 100$ kHz	-	1280	-	pF
		$V_R = 200$ V	$f = 100$ kHz	-	139	-	
		$V_R = 400$ V	$f = 100$ kHz	-	108	-	

Table 6. THERMAL RESISTANCE

Parameters		Min	Typ	Max	Unit
$R_{\theta JC}$ (per MOSFET chip)	Q1,Q2 Thermal Resistance Junction-to-Case (Note 5)	-	0.47	0.66	$^\circ\text{C}/\text{W}$
$R_{\theta JS}$ (per MOSFET chip)	Q1,Q2 Thermal Resistance Junction-to-Sink (Note 6)	-	0.95	-	$^\circ\text{C}/\text{W}$
$R_{\theta JC}$ (per DIODE chip)	D1,D2 Thermal Resistance Junction-to-Case (Note 5)	-	1.78	2.3	$^\circ\text{C}/\text{W}$
$R_{\theta JS}$ (per DIODE chip)	D1,D2 Thermal Resistance Junction-to-Sink (Note 6)	-	3.10	-	$^\circ\text{C}/\text{W}$

5. Test method compliant with MIL STD 883-1012.1, from case temperature under the chip to case temperature measured below the package at the chip center, Cosmetic oxidation and discoloration on the DBC surface allowed

6. Defined by thermal simulation assuming the module is mounted on a 5 mm Al-360 die casting material with 30 μm of 1.8 W/mK thermal interface material

Table 7. ISOLATION (Isolation resistance at tested voltage between the base plate and to control pins or power terminals.)

Test	Test Conditions	Isolation Resistance	Unit
Leakage @ Isolation Voltage (Hi-Pot)	$V_{AC} = 5$ kV, 50 Hz	100M <	Ω

FAM65CR51ADZ1, FAM65CR51ADZ2

PARAMETER DEFINITIONS

Reference to Table 3: Parameter of MOSFET Electrical Specifications

BV_{DSS}	<p>Q1, Q2 MOSFET Drain-to-Source Breakdown Voltage</p> <p>The maximum drain-to-source voltage the MOSFET can endure without the avalanche breakdown of the body- drain P-N junction in off state.</p> <p>The measurement conditions are to be found in Table 3.</p> <p>The typ. Temperature behavior is described in Figure 13</p>
$V_{GS(th)}$	<p>Q1, Q2 MOSFET Gate to Source Threshold Voltage</p> <p>The gate-to-source voltage measurement is triggered by a threshold ID current given in conditions at Table 4.</p> <p>The typ. Temperature behavior can be found in Figure 10</p>
$R_{DS(on)}$	<p>Q1, Q2 MOSFET On Resistance</p> <p>$R_{DS(on)}$ is the total resistance between the source and the drain during the on state.</p> <p>The measurement conditions are to be found in Table 3.</p> <p>The typ behavior can be found in Figure 11 and Figure 12 as well as Figure 17</p>
g_{fs}	<p>Q1, Q2 MOSFET Forward Transconductance</p> <p>Transconductance is the gain in the MOSFET, expressed in the Equation below.</p> <p>It describes the change in drain current by the change in the gate-source bias voltage: $g_{fs} = [\Delta I_{DS} / \Delta V_{GS}]_{V_{DS}}$</p>
I_{GSS}	<p>Q1, Q2 MOSFET Gate-to-Source Leakage Current</p> <p>The current flowing from Gate to Source at the maximum allowed VGS</p> <p>The measurement conditions are described in the Table 3.</p>
I_{DSS}	<p>Q1, Q2 MOSFET Drain-to-Source Leakage Current</p> <p>Drain - Source current is measured in off state while providing the maximum allowed drain-to-source voltage and the gate is shorted to the source.</p> <p>I_{DSS} has a positive temperature coefficient.</p>

FAM65CR51ADZ1, FAM65CR51ADZ2

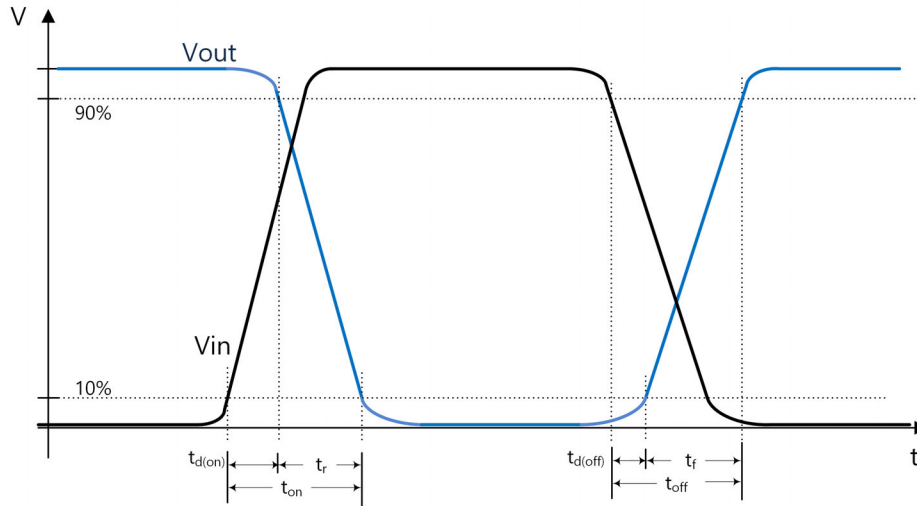

Figure 3. Timing Measurement Variable Definition

Table 8. PARAMETER OF SWITCHING CHARACTERISTICS

Turn-On Delay ($t_{d(on)}$)	This is the time needed to charge the input capacitance, C_{iss} , before the load current I_D starts flowing. The measurement conditions are described in the Table 3. For signal definition please check Figure 3 above.
Rise Time (t_r)	The rise time is the time to discharge output capacitance, C_{oss} . After that time the MOSFET conducts the given load current I_D . The measurement conditions are described in the Table 3. For signal definition please check Figure 3 above.
Turn-On Time (t_{on})	Is the sum of turn-on-delay and rise time
Turn-Off Delay ($t_{d(off)}$)	$t_{d(off)}$ is the time to discharge C_{iss} after the MOSFET is turned off. During this time the load current I_D is still flowing. The measurement conditions are described in the Table 3. For signal definition please check Figure 3 above.
Fall Time (t_f)	The fall time, t_f , is the time to charge the output capacitance, C_{oss} . During this time the load current drops down and the voltage V_{DS} rises accordingly. The measurement conditions are described in the Table 3. For signal definition please check Figure 3 above.
Turn-Off Time (t_{off})	Is the sum of turn-off-delay and fall time

FAM65CR51ADZ1, FAM65CR51ADZ2

TYPICAL CHARACTERISTICS – MOSFETs

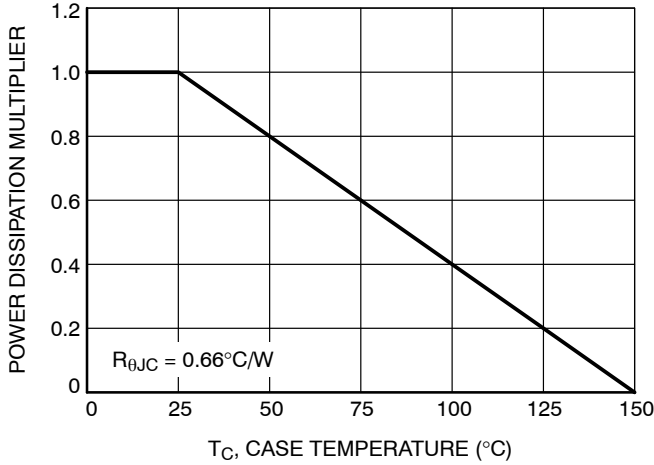

Figure 4. Normalized Power Dissipation vs. Case Temperature

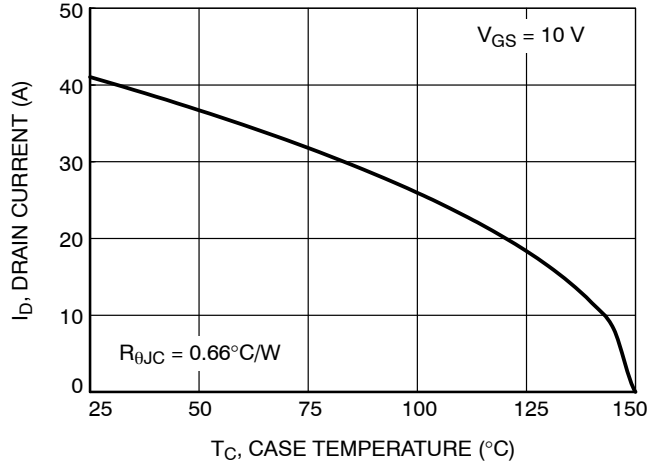

Figure 5. Maximum Continuous I_D vs. Case Temperature

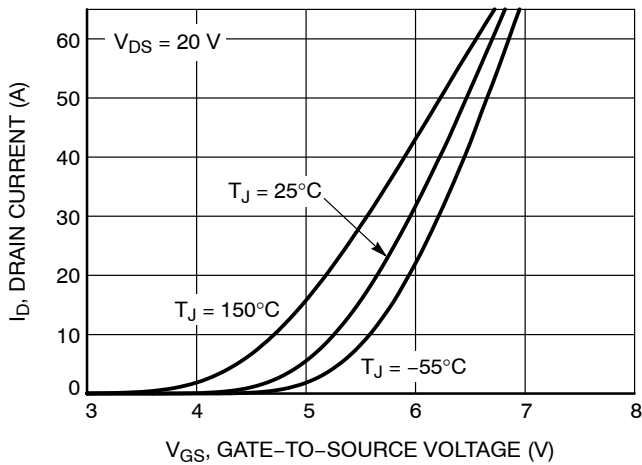

Figure 6. Transfer Characteristics

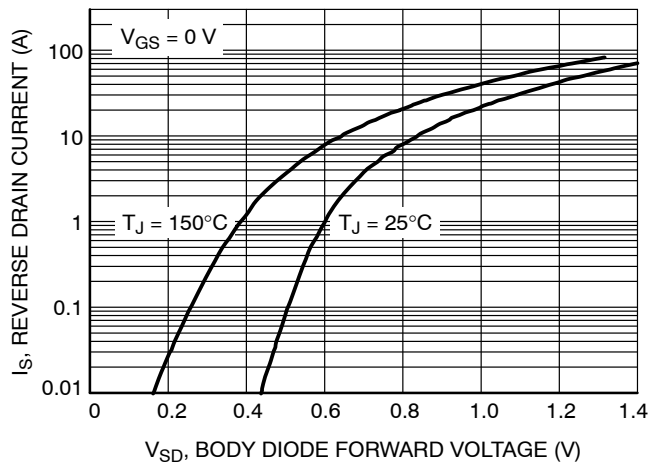

Figure 7. Forward Diode

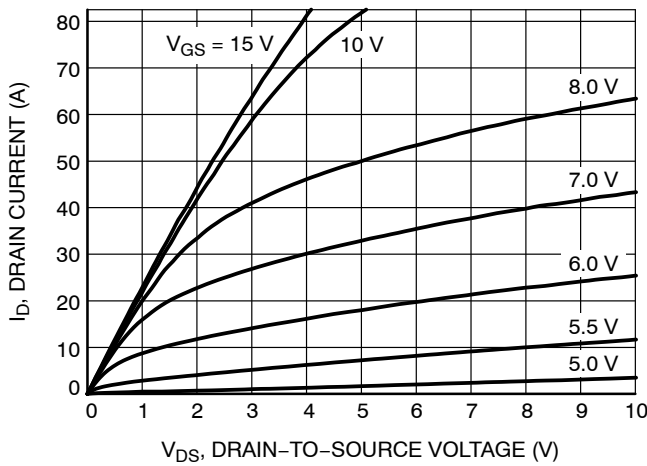

Figure 8. On Region Characteristics (25°C)

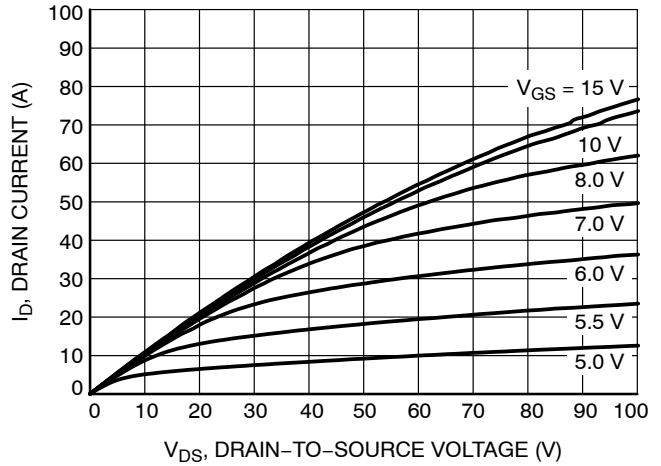

Figure 9. On Region Characteristics (150°C)

FAM65CR51ADZ1, FAM65CR51ADZ2

TYPICAL CHARACTERISTICS – MOSFETS

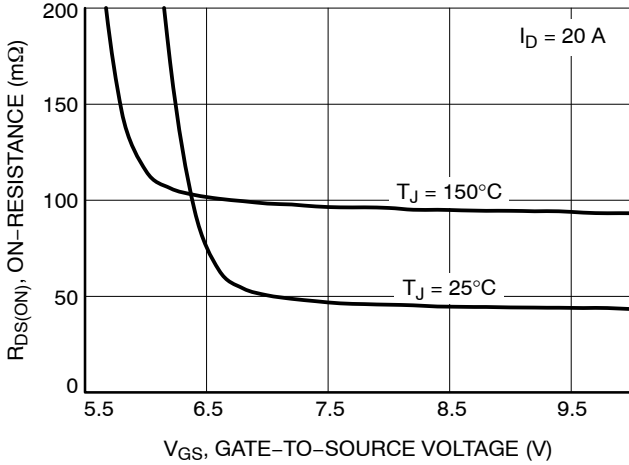

Figure 10. On-Resistance vs. Gate-to-Source Voltage

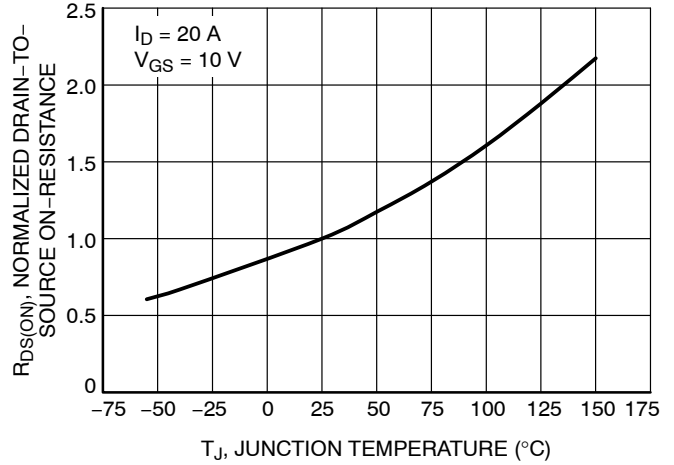

Figure 11. $R_{DS(norm)}$ vs. Junction Temperature

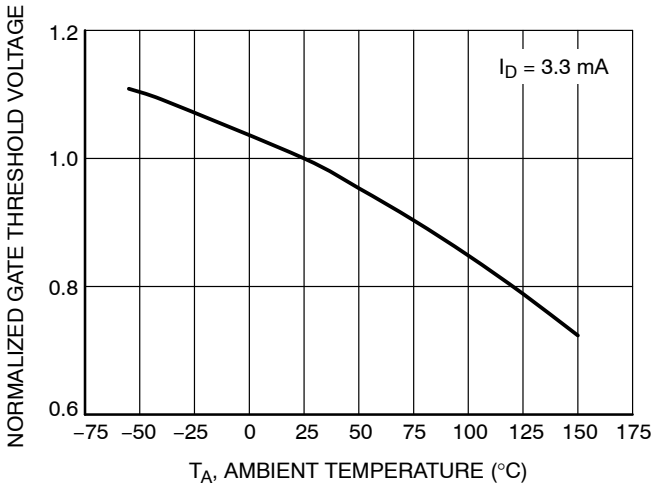

Figure 12. Normalized Gate Threshold Voltage vs. Temperature

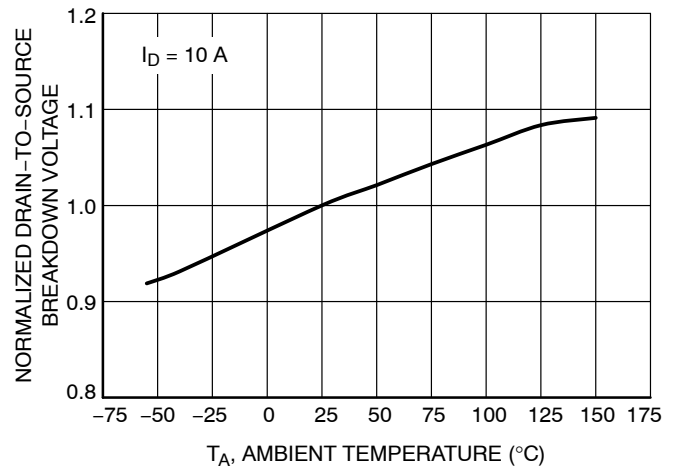

Figure 13. Normalized Breakdown Voltage vs. Temperature

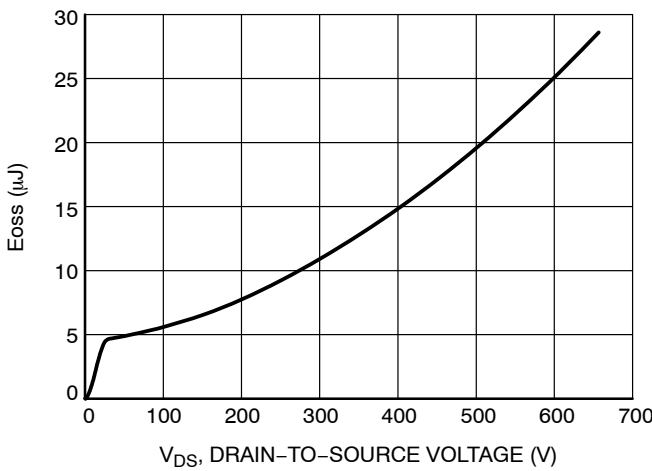

Figure 14. E_{oss} vs. Drain-to-Source Voltage

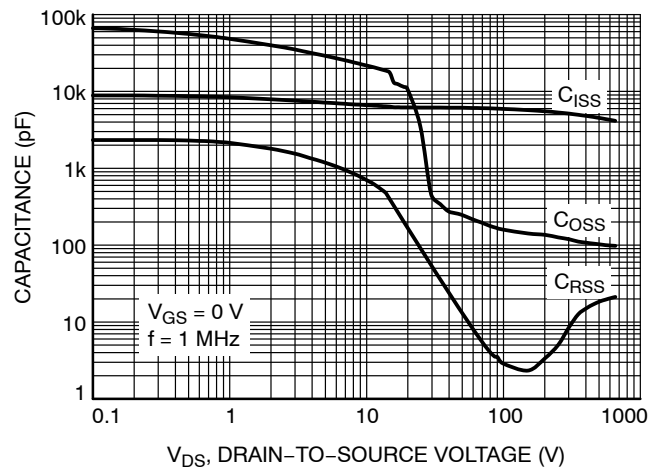

Figure 15. Capacitance Variation

FAM65CR51ADZ1, FAM65CR51ADZ2

TYPICAL CHARACTERISTICS – MOSFETs

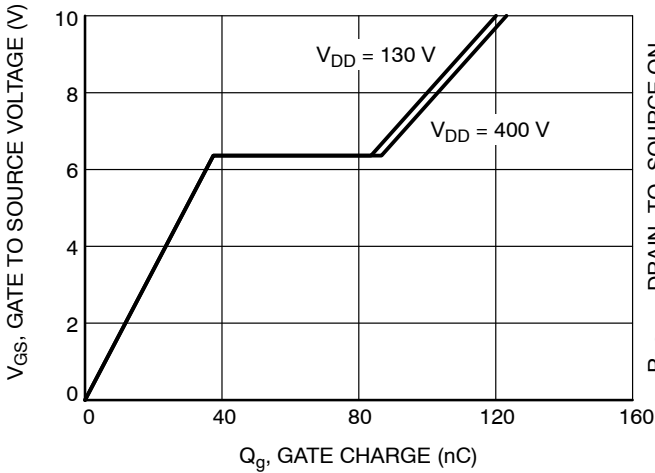

Figure 16. Gate Charge Characteristics

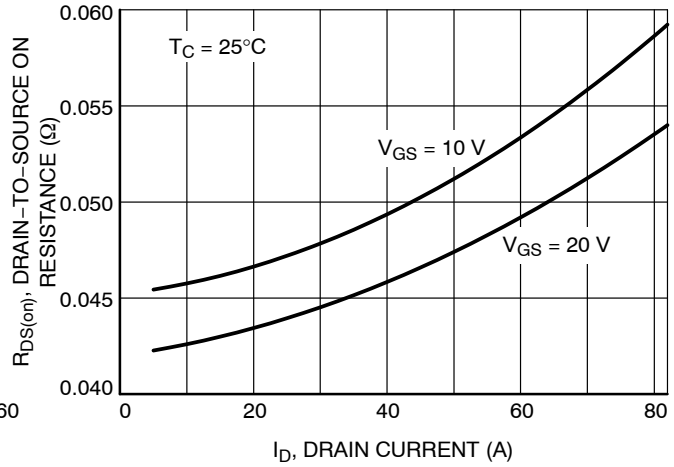

Figure 17. ON-Resistance Variation with Drain Current and Gate Voltage

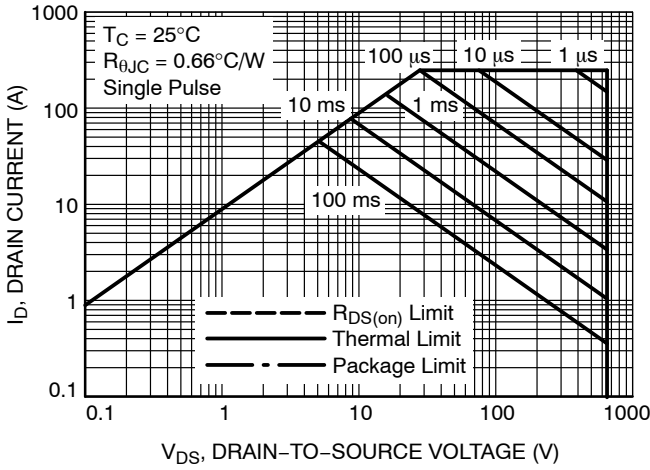

Figure 18. Safe Operating Area

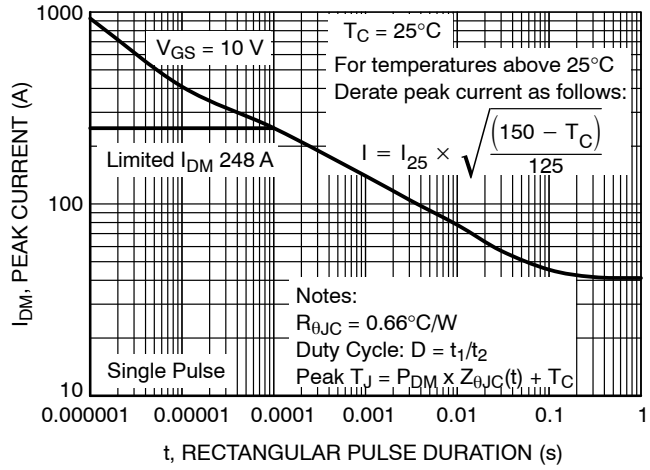

Figure 19. Peak Current Capability

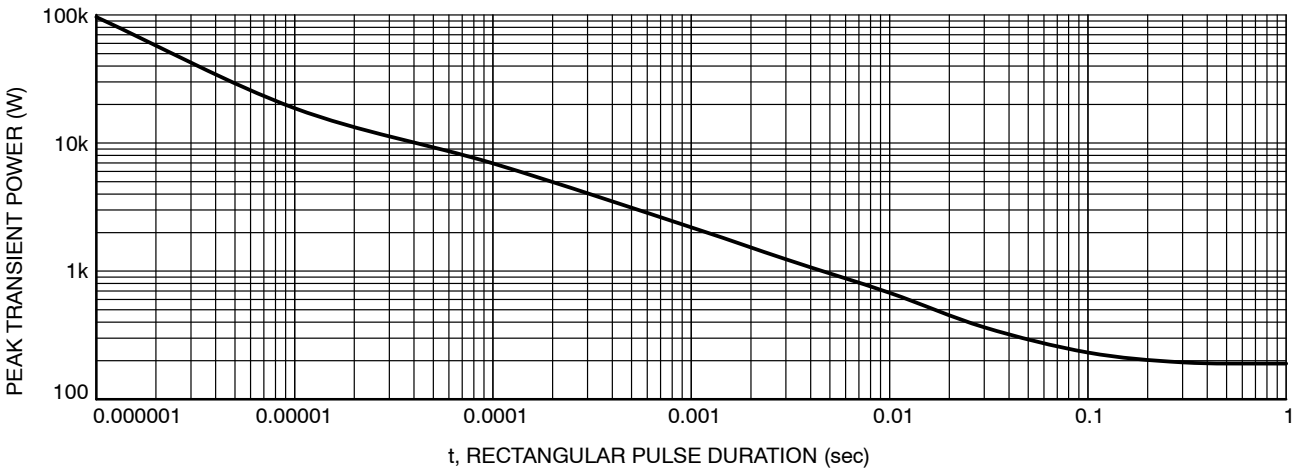

Figure 20. Peak Power

FAM65CR51ADZ1, FAM65CR51ADZ2

TYPICAL CHARACTERISTICS – DIODES

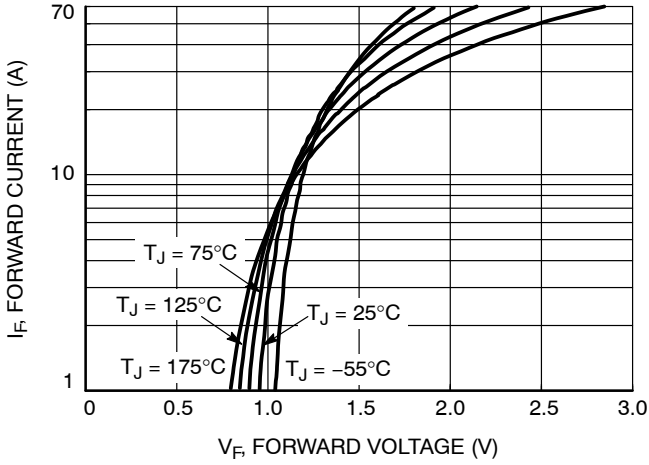

Figure 21. Typical Forward Voltage Drop vs. Forward Current

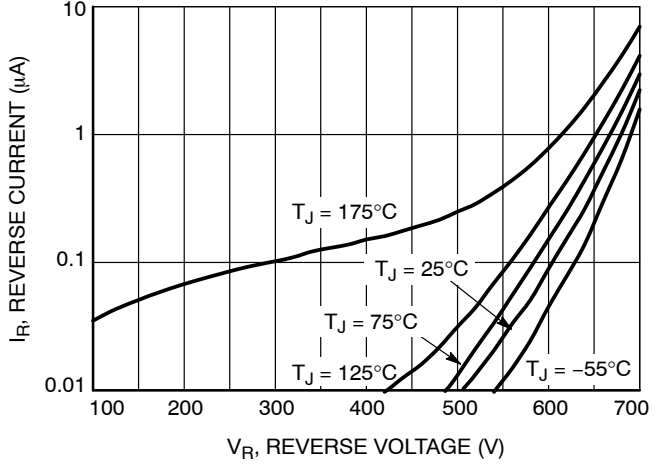

Figure 22. Typical Reverse Current vs. Reverse Voltage

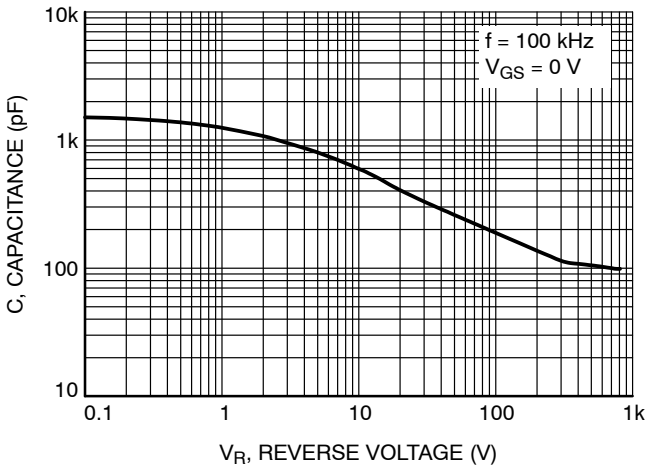

Figure 23. Capacitance

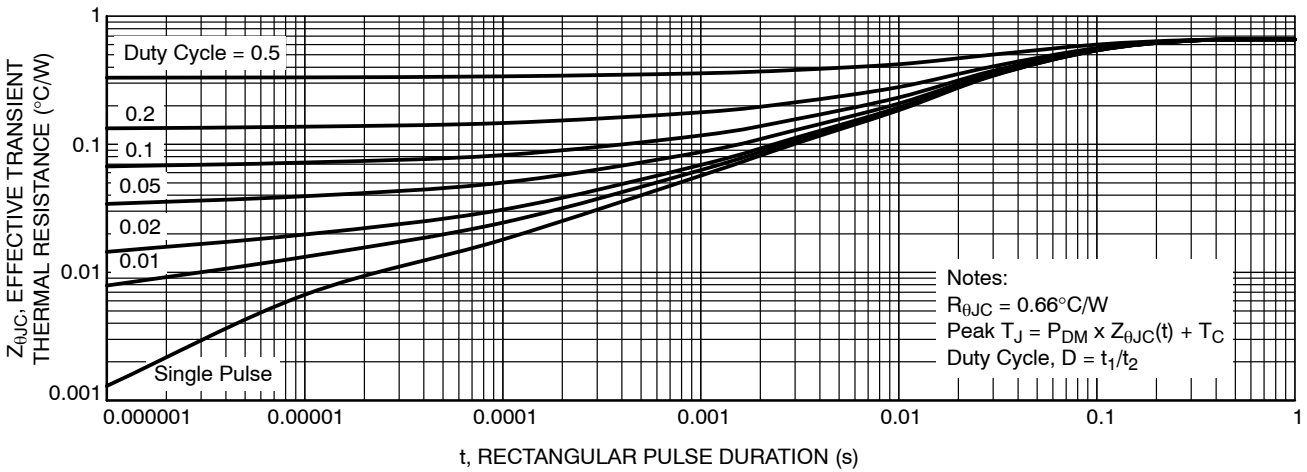

Figure 24. Transient Thermal Impedance

MECHANICAL CASE OUTLINE

PACKAGE DIMENSIONS



APMCD-A16 / 12LD, AUTOMOTIVE MODULE

CASE MODGG

ISSUE C

DATE 03 NOV 2021

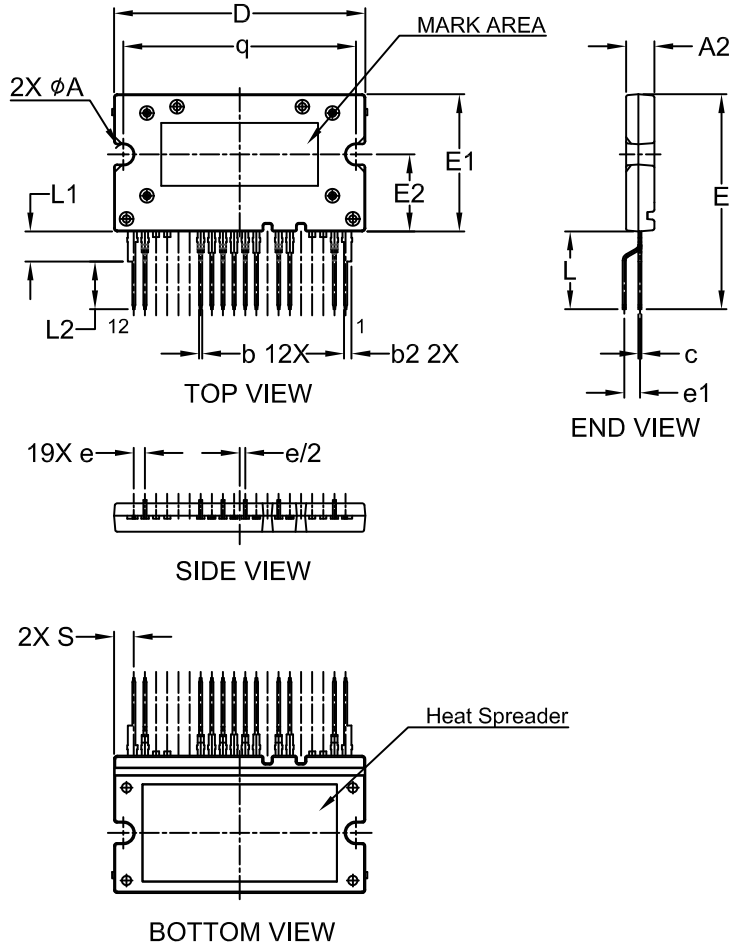
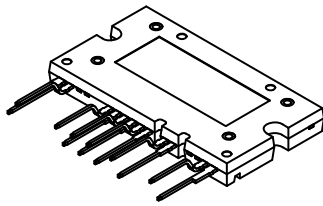

NOTES:

1. DIMENSIONING AND TOLERANCING PER ASME Y14.5M, 2009.
2. CONTROLLING DIMENSION: MILLIMETERS
3. DIMENSIONS ARE EXCLUSIVE OF BURRS, MOLD FLASH AND TIE BAR EXTRUSIONS.

DIM	MILLIMETERS		
	MIN.	NOM.	MAX.
A2	4.30	4.50	4.70
b	0.45	0.50	0.60
b2	1.15	1.20	1.30
c	0.45	0.50	0.60
D	39.90	40.10	40.30
E	33.80	34.30	34.80
E1	21.70	21.90	22.10
E2	12.10	12.30	12.50
e	1.478	1.778	2.078
e1	2.20	2.50	2.80
L	12.10	12.40	12.70
L1	4.80 REF		
L2	7.30	7.60	7.90
q	36.85	37.10	37.35
S	3.159 REF		
φA	3.00	3.20	3.40

GENERIC MARKING DIAGRAM*

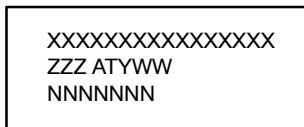

XXXX = Specific Device Code
 ZZZ = Lot ID
 AT = Assembly & Test Location
 Y = Year
 WW = Work Week
 NNN = Serial Number

*This information is generic. Please refer to device data sheet for actual part marking. Pb-Free indicator, "G" or microdot "μ", may or may not be present. Some products may not follow the Generic Marking.

DOCUMENT NUMBER:	98AON94738G	Electronic versions are uncontrolled except when accessed directly from the Document Repository. Printed versions are uncontrolled except when stamped "CONTROLLED COPY" in red.
DESCRIPTION:	APMCD-A16 / 12LD, AUTOMOTIVE MODULE	PAGE 1 OF 1

onsemi and ONSEMI are trademarks of Semiconductor Components Industries, LLC dba onsemi or its subsidiaries in the United States and/or other countries. onsemi reserves the right to make changes without further notice to any products herein. onsemi makes no warranty, representation or guarantee regarding the suitability of its products for any particular purpose, nor does onsemi assume any liability arising out of the application or use of any product or circuit, and specifically disclaims any and all liability, including without limitation special, consequential or incidental damages. onsemi does not convey any license under its patent rights nor the rights of others.

MECHANICAL CASE OUTLINE

PACKAGE DIMENSIONS



APMCD-B16 / 12LD, AUTOMOTIVE MODULE

CASE MODGK
ISSUE D

DATE 04 NOV 2021

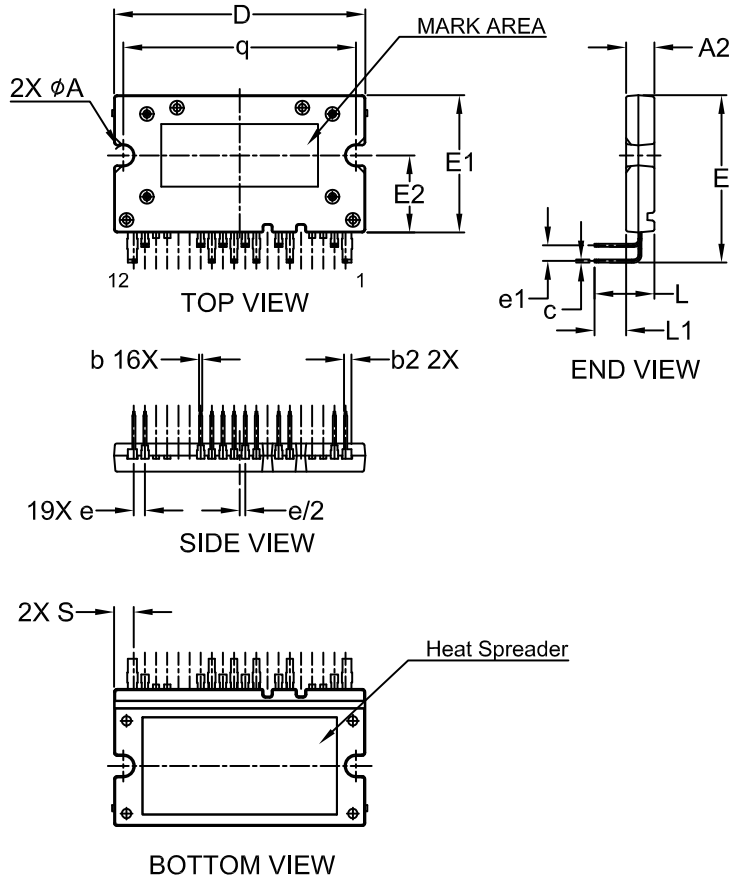
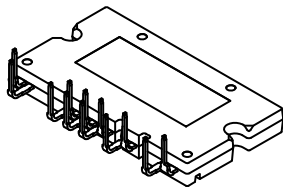

NOTES:

1. DIMENSIONING AND TOLERANCING PER ASME Y14.5M, 2009.
2. CONTROLLING DIMENSION: MILLIMETERS
3. DIMENSIONS ARE EXCLUSIVE OF BURRS, MOLD FLASH AND TIE BAR EXTRUSIONS.

DIM	MILLIMETERS		
	MIN.	NOM.	MAX.
A2	4.30	4.50	4.70
b	0.45	0.50	0.60
b2	1.15	1.20	1.30
c	0.45	0.50	0.60
D	39.90	40.10	40.30
E	26.20	26.70	27.20
E1	21.70	21.90	22.10
E2	12.10	12.30	12.50
e	1.478	1.778	2.078
e1	2.20	2.50	2.80
L	9.20	9.55	9.90
L1	4.70	5.05	5.40
q	36.85	37.10	37.35
S	3.159 REF		
ϕA	3.00	3.20	3.40

GENERIC MARKING DIAGRAM*

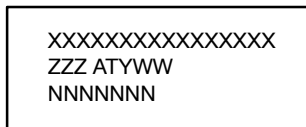

XXXX = Specific Device Code
 ZZZ = Lot ID
 AT = Assembly & Test Location
 Y = Year
 W = Work Week
 NNN = Serial Number

*This information is generic. Please refer to device data sheet for actual part marking. Pb-Free indicator, "G" or microdot "μ", may or may not be present. Some products may not follow the Generic Marking.

DOCUMENT NUMBER:	98AON97134G	Electronic versions are uncontrolled except when accessed directly from the Document Repository. Printed versions are uncontrolled except when stamped "CONTROLLED COPY" in red.
DESCRIPTION:	APMCD-B16 / 12LD, AUTOMOTIVE MODULE	PAGE 1 OF 1

onsemi and ONSEMI are trademarks of Semiconductor Components Industries, LLC dba onsemi or its subsidiaries in the United States and/or other countries. onsemi reserves the right to make changes without further notice to any products herein. onsemi makes no warranty, representation or guarantee regarding the suitability of its products for any particular purpose, nor does onsemi assume any liability arising out of the application or use of any product or circuit, and specifically disclaims any and all liability, including without limitation special, consequential or incidental damages. onsemi does not convey any license under its patent rights nor the rights of others.

onsemi, **Onsemi**, and other names, marks, and brands are registered and/or common law trademarks of Semiconductor Components Industries, LLC dba "**onsemi**" or its affiliates and/or subsidiaries in the United States and/or other countries. **onsemi** owns the rights to a number of patents, trademarks, copyrights, trade secrets, and other intellectual property. A listing of **onsemi**'s product/patent coverage may be accessed at www.onsemi.com/site/pdf/Patent-Marking.pdf. **onsemi** reserves the right to make changes at any time to any products or information herein, without notice. The information herein is provided "as-is" and **onsemi** makes no warranty, representation or guarantee regarding the accuracy of the information, product features, availability, functionality, or suitability of its products for any particular purpose, nor does **onsemi** assume any liability arising out of the application or use of any product or circuit, and specifically disclaims any and all liability, including without limitation special, consequential or incidental damages. Buyer is responsible for its products and applications using **onsemi** products, including compliance with all laws, regulations and safety requirements or standards, regardless of any support or applications information provided by **onsemi**. "Typical" parameters which may be provided in **onsemi** data sheets and/or specifications can and do vary in different applications and actual performance may vary over time. All operating parameters, including "Typicals" must be validated for each customer application by customer's technical experts. **onsemi** does not convey any license under any of its intellectual property rights nor the rights of others. **onsemi** products are not designed, intended, or authorized for use as a critical component in life support systems or any FDA Class 3 medical devices or medical devices with a same or similar classification in a foreign jurisdiction or any devices intended for implantation in the human body. Should Buyer purchase or use **onsemi** products for any such unintended or unauthorized application, Buyer shall indemnify and hold **onsemi** and its officers, employees, subsidiaries, affiliates, and distributors harmless against all claims, costs, damages, and expenses, and reasonable attorney fees arising out of, directly or indirectly, any claim of personal injury or death associated with such unintended or unauthorized use, even if such claim alleges that **onsemi** was negligent regarding the design or manufacture of the part. **onsemi** is an Equal Opportunity/Affirmative Action Employer. This literature is subject to all applicable copyright laws and is not for resale in any manner.

PUBLICATION ORDERING INFORMATION

LITERATURE FULFILLMENT:

Email Requests to: orderlit@onsemi.com

onsemi Website: www.onsemi.com

TECHNICAL SUPPORT

North American Technical Support:

Voice Mail: 1 800-282-9855 Toll Free USA/Canada

Phone: 011 421 33 790 2910

Europe, Middle East and Africa Technical Support:

Phone: 00421 33 790 2910

For additional information, please contact your local Sales Representative