

**TN3467A**

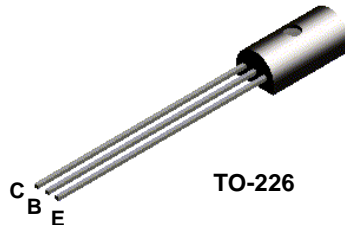

**MMPQ3467**

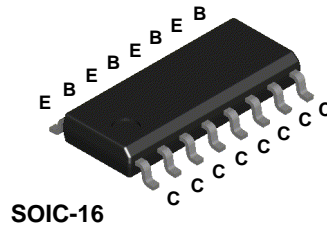

**PNP Switching Transistor**

This device is designed for high speed saturated switching applications at currents to 800 mA. Sourced from Process 70.

**Absolute Maximum Ratings\*** TA = 25°C unless otherwise noted

Symbol	Parameter	Value	Units
V <sub>CEO</sub>	Collector-Emitter Voltage	40	V
V <sub>CBO</sub>	Collector-Base Voltage	40	V
V <sub>EBO</sub>	Emitter-Base Voltage	5.0	V
I <sub>C</sub>	Collector Current - Continuous	1.2	A
T <sub>J</sub> , T <sub>stg</sub>	Operating and Storage Junction Temperature Range	-55 to +150	°C

\*These ratings are limiting values above which the serviceability of any semiconductor device may be impaired.

**NOTES:**

- 1) These ratings are based on a maximum junction temperature of 150 degrees C.
- 2) These are steady state limits. The factory should be consulted on applications involving pulsed or low duty cycle operations.

**Thermal Characteristics** TA = 25°C unless otherwise noted

Symbol	Characteristic	Max		Units
		TN3467A	MMPQ3467	
P <sub>D</sub>	Total Device Dissipation Derate above 25°C	1.0	1.0	W
		8.0	8.0	mW/°C
R <sub>θJC</sub>	Thermal Resistance, Junction to Case	50		°C/W
R <sub>θJA</sub>	Thermal Resistance, Junction to Ambient Effective 4 Die Each Die	125		°C/W
			125	°C/W
			240	°C/W

# PNP Switching Transistor

(continued)

## Electrical Characteristics

TA = 25°C unless otherwise noted

Symbol	Parameter	Test Conditions	Min	Max	Units
<b>OFF CHARACTERISTICS</b>					
$V_{(BR)CEO}$	Collector-Emitter Breakdown Voltage*	$I_C = 10 \text{ mA}, I_B = 0$	40		V
$V_{(BR)CBO}$	Collector-Base Breakdown Voltage	$I_C = 10 \text{ } \mu\text{A}, I_E = 0$	40		V
$V_{(BR)EBO}$	Emitter-Base Breakdown Voltage	$I_E = 10 \text{ } \mu\text{A}, I_C = 0$	5.0		V
$I_{BEV}$	Base-Cutoff Current	$V_{CE} = 30 \text{ V}, V_{BE} = 3.0 \text{ V}$		120	nA
$I_{CEX}$	Collector-Cutoff Current	$V_{CE} = 30 \text{ V}, V_{BE} = 3.0 \text{ V}$		100	nA
$I_{CBO}$	Collector-Cutoff Current	$V_{CB} = 30 \text{ V}, I_E = 0$ $V_{CB} = 30 \text{ V}, I_E = 0, T_A = 150^\circ\text{C}$		0.01 15	$\mu\text{A}$ $\mu\text{A}$

## ON CHARACTERISTICS\*

$h_{FE}$	DC Current Gain	$I_C = 150 \text{ mA}, V_{CE} = 1.0 \text{ V}$ $I_C = 500 \text{ mA}, V_{CE} = 1.0 \text{ V}$ $I_C = 1.0 \text{ A}, V_{CE} = 5.0 \text{ V}$	40 40 40	120	
$V_{CE(sat)}$	Collector-Emitter Saturation Voltage	$I_C = 150 \text{ mA}, I_B = 15 \text{ mA}$ $I_C = 500 \text{ mA}, I_B = 50 \text{ mA}$ $I_C = 1.0 \text{ A}, I_B = 100 \text{ mA}$		0.3 0.5 1.0	V V V
$V_{BE(sat)}$	Base-Emitter Saturation Voltage	$I_C = 150 \text{ mA}, I_B = 15 \text{ mA}$ $I_C = 500 \text{ mA}, I_B = 50 \text{ mA}$ $I_C = 1.0 \text{ A}, I_B = 100 \text{ mA}$	0.8	1.0 1.2 1.6	V V V

## SMALL SIGNAL CHARACTERISTICS

$f_T$	Current Gain-Bandwidth Product	$I_C = 50 \text{ mA}, V_{CE} = 10 \text{ V},$ $f = 100 \text{ MHz}$	175		MHz
$C_{obo}$	Output Capacitance	$V_{CB} = 10 \text{ V}, I_E = 0, f = 1.0 \text{ KHz}$		25	pF
$C_{ibo}$	Input Capacitance	$V_{BE} = 0.5 \text{ V}, I_C = 0, f = 1.0 \text{ KHz}$		100	pF

## SWITCHING CHARACTERISTICS (except for MMPQ3467)

$t_d$	Delay Time	$V_{CC} = 30 \text{ V}, V_{BE} = 2.0 \text{ V},$		10	ns
$t_r$	Rise Time	$I_C = 500 \text{ mA}, I_{B1} = 50 \text{ mA}$		30	ns
$t_s$	Storage Time	$V_{CC} = 30 \text{ V}, I_C = 500 \text{ mA},$		60	ns
$t_f$	Fall Time	$I_{B1} = I_{B2} = 50 \text{ mA}$		30	ns

\*Pulse Test: Pulse Width  $\leq 300 \text{ } \mu\text{s}$ , Duty Cycle  $\leq 1.0\%$

TN3467A / MMPQ3467

DC Typical Characteristics

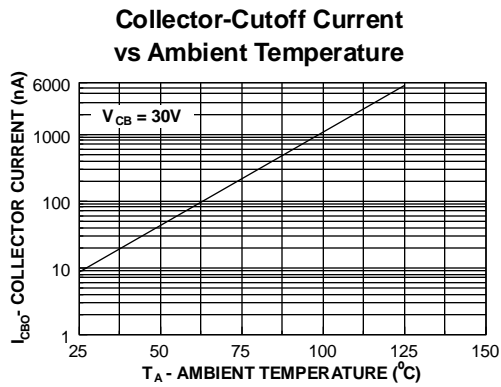
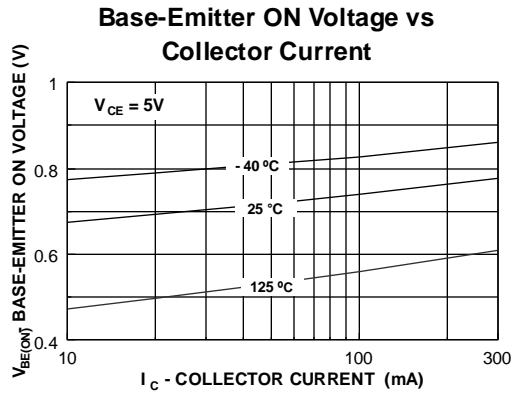
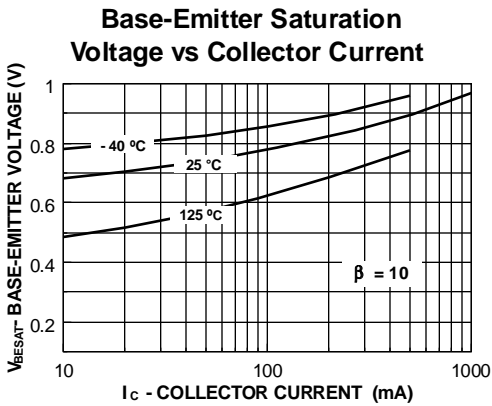
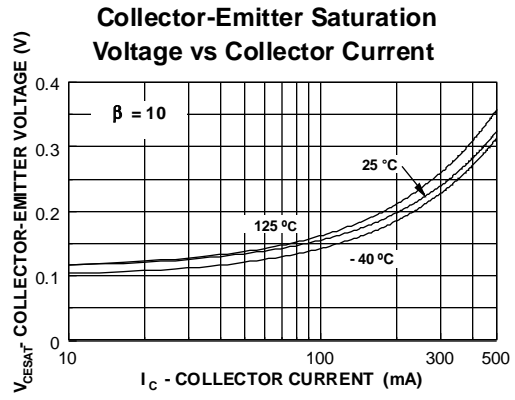
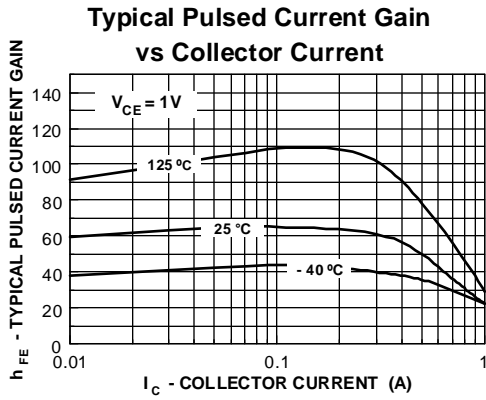

AC Typical Characteristics

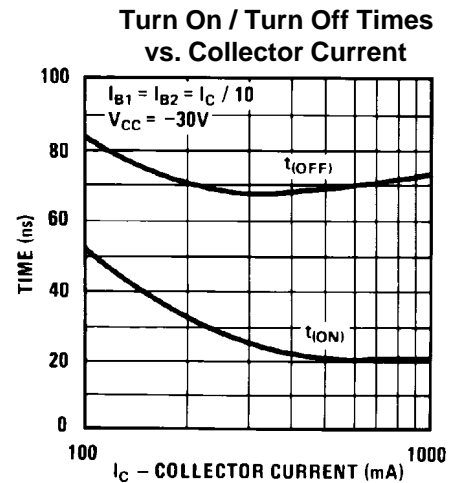
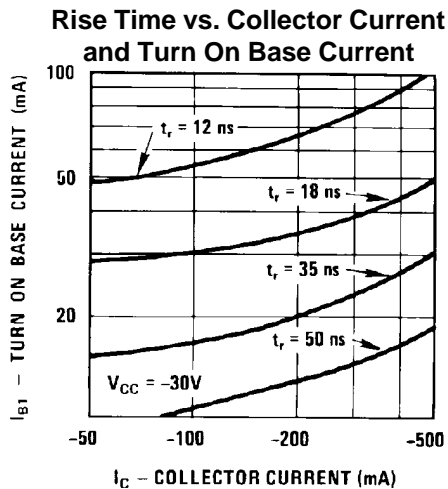
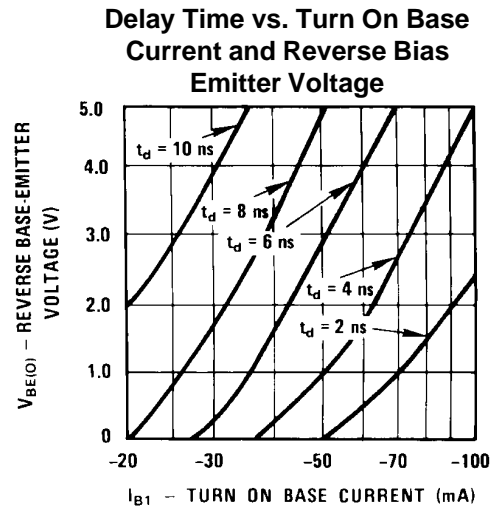
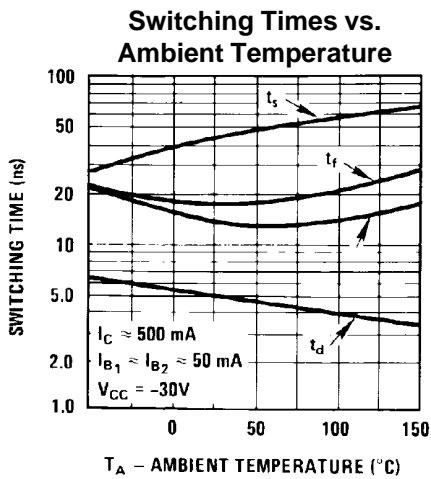
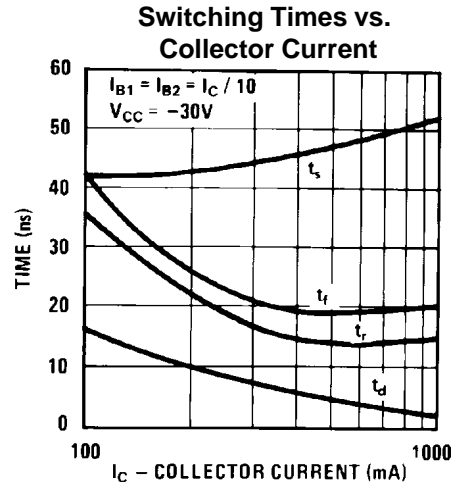
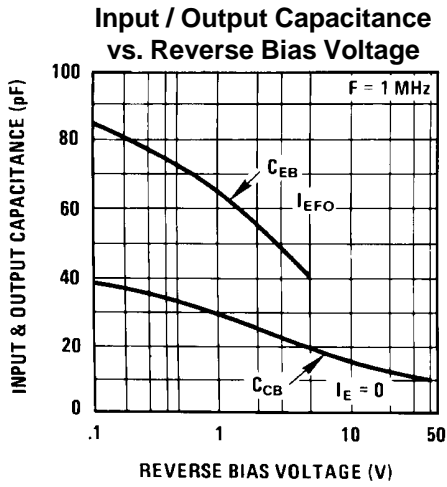

AC Typical Characteristics (continued)

Fall Time vs. Turn On and Turn Off Base Currents

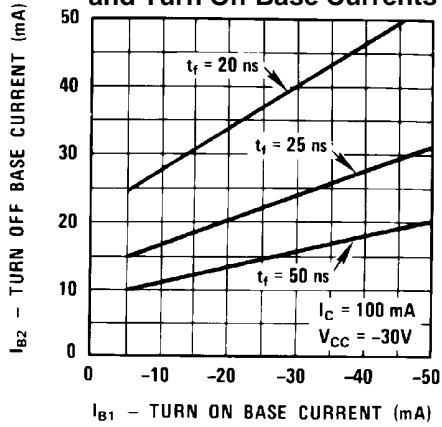

Fall Time vs. Turn On and Turn Off Base Currents

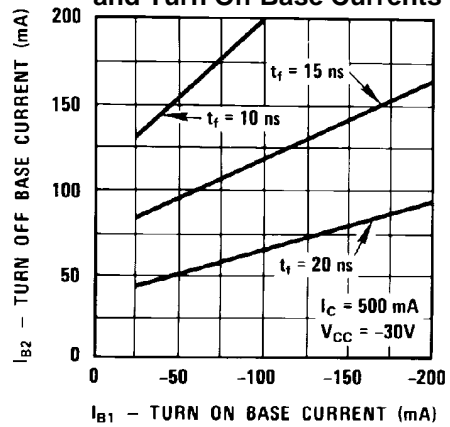

Storage Time vs. Turn On and Turn Off Base Currents

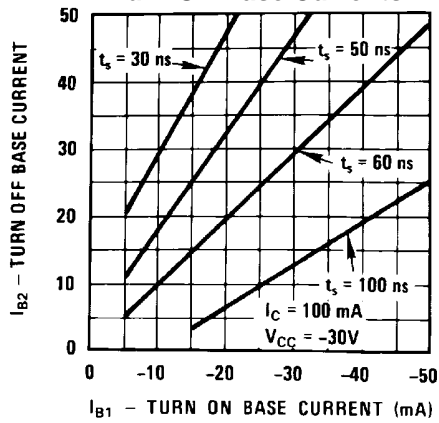

Storage Time vs. Turn On and Turn Off Base Currents

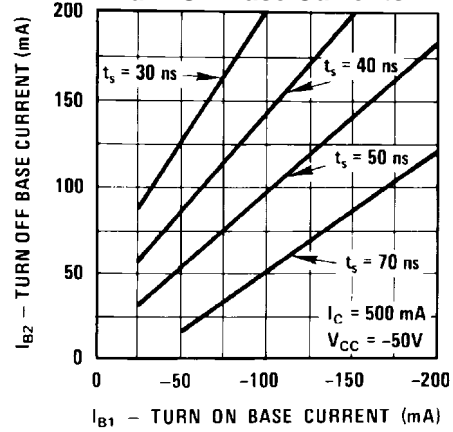

AC Typical Characteristics (continued)

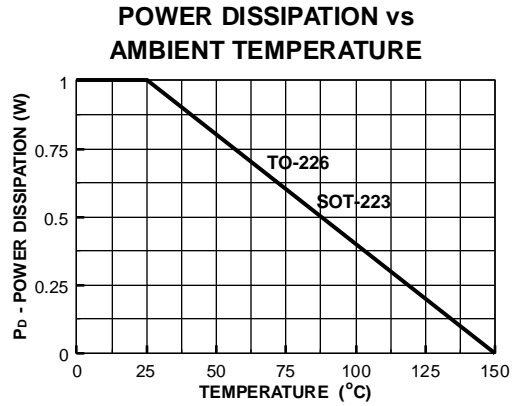
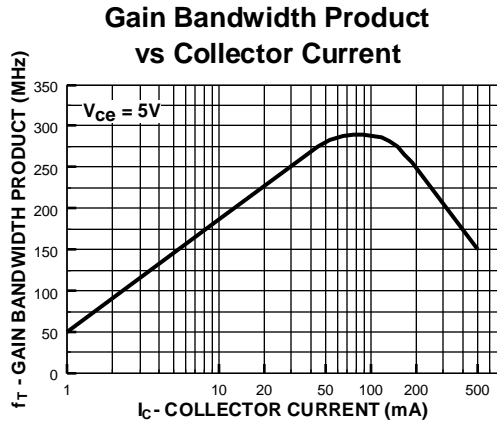

Test Circuits

PW = 200 ns  
Rise Time  $\leq 2.0$  ns  
Duty Cycle = 2%

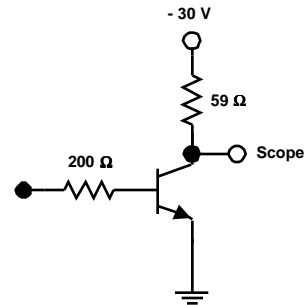
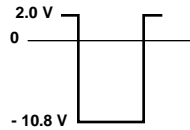

FIGURE 1:  $t_{ON}$  Equivalent Test Circuit

$2.0 < t_1 < 500 \mu s$   
 $t_2 < 5$  ns  
 $t_3 > 1.0 \mu s$   
Duty Cycle = 2%

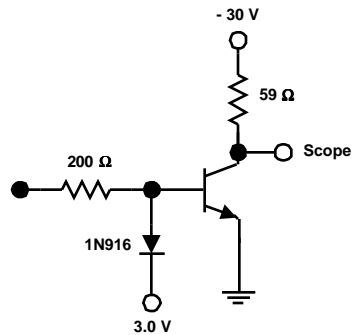
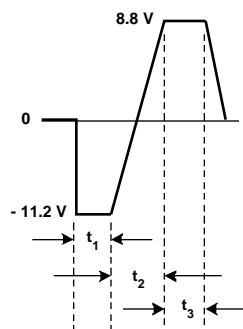

FIGURE 2:  $t_{OFF}$  Equivalent Test Circuit