

Features

- **Pb-Free package is available**
 - RoHS product for packing code suffix "G"
 - Halogen free product for packing code suffix "H"
- Epoxy meets UL 94 V-0 flammability rating
- Moisture Sensitivity Level 1
- Built-in bias resistors enable the configuration of an inverter circuit without connecting external input resistors
- The bias resistors consist of thin-film resistors with complete isolation to allow negative biasing of the input. They also have the advantage of almost completely eliminating parasitic effects.
- Only the on/off conditions need to be set for operation, making device design easy

Absolute maximum ratings @ 25°C

| Symbol | Parameter | Min | Typ | Max | Unit |
|-----------------------|----------------------|-----|--------------|-----|------|
| V_{CC} | Supply voltage | --- | -50 | --- | V |
| V_{IN} | Input voltage | -12 | --- | 5 | V |
| I_O $I_{C(MAX)}$ | Output current | --- | -100 -100 | --- | mA |
| P_d | Power dissipation | --- | 200 | --- | mW |
| T_j | Junction temperature | --- | 150 | --- | °C |
| T_{stg} | Storage temperature | -55 | --- | 150 | °C |

Electrical Characteristics @ 25°C

| Symbol | Parameter | Min | Typ | Max | Unit |
|--------------|--|------|-----|------|------------|
| $V_{I(off)}$ | Input voltage ($V_{CC}=-5V, I_O=-100 \mu A$) | -0.5 | --- | --- | V |
| $V_{I(on)}$ | Input voltage ($V_O=-0.3V, I_O=-5mA$) | --- | --- | -1.1 | V |
| $V_{O(on)}$ | Output voltage ($I_O/I_I=-5mA/-0.25mA$) | --- | --- | -0.3 | V |
| I_I | Input current ($V_I=-5V$) | --- | --- | -3.6 | mA |
| $I_{O(off)}$ | Output current ($V_{CC}=-50V, V_I=0$) | --- | --- | -0.5 | μA |
| G_1 | DC current gain ($V_O=-5V, I_O=-10mA$) | 80 | --- | --- | |
| R_1 | Input resistance | 1.54 | 2.2 | 2.86 | K Ω |
| R_2/R_1 | Resistance ratio | 17 | 21 | 26 | |
| f_T | Transition frequency ($V_O=-10V, I_O=5mA, f=100MHz$) | --- | 250 | --- | MHz |

SOT-323

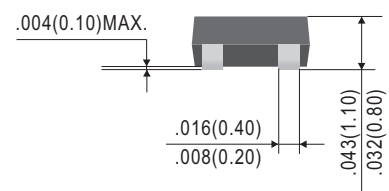
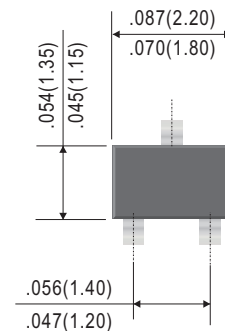
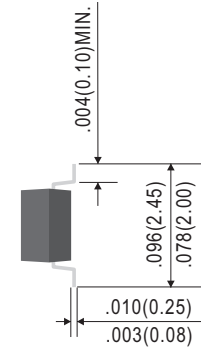

Dimensions in inches and (millimeters)

Equivalent circuit

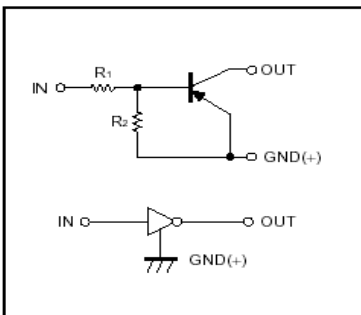

*Marking: 132

Suggested Solder Pad Layout

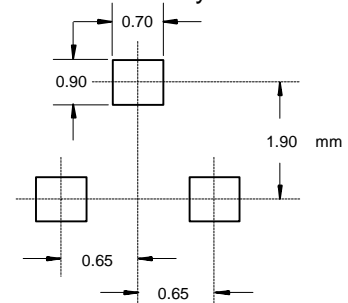

● **Electrical characteristic curves**

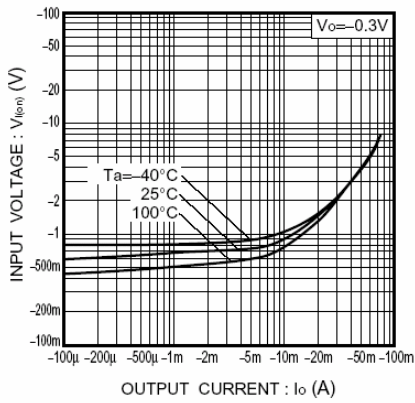

Fig.1 Input voltage vs. output current (ON characteristics)

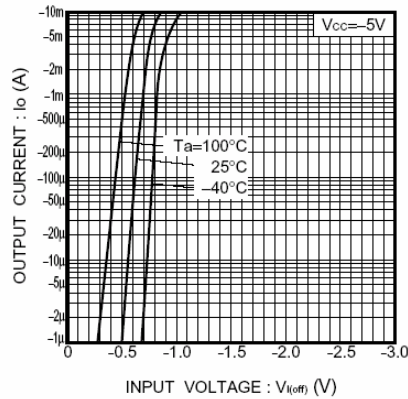

Fig.2 Output current vs. input voltage (OFF characteristics)

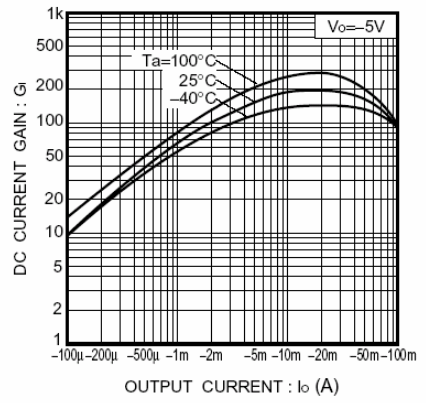

Fig.3 DC current gain vs. output current

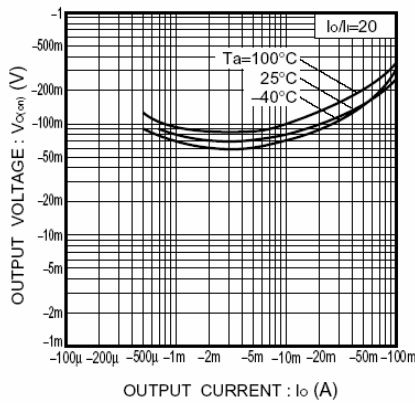

Fig.4 Output voltage vs. output current

Ordering Information:

| Device PN | Packing |
|--|--------------------------|
| DTA123JUA -T ⁽¹⁾ G ⁽²⁾ -WS | Tape & Reel: 3 Kpcs/Reel |

Note: (1) Packing code, Tape & Reel Packing

(2) RoHS product for packing code suffix "G" ; Halogen free product for packing code suffix "H"

Disclaimer

WILLAS reserves the right to make changes without notice to any product specification herein, to make corrections, modifications, enhancements or other changes. WILLAS or anyone on its behalf assumes no responsibility or liability for any errors or inaccuracies. Data sheet specifications and its information contained are intended to provide a product description only. "Typical" parameters which may be included on WILLAS data sheets and/ or specifications can and do vary in different applications and actual performance may vary over time. WILLAS does not assume any liability arising out of the application or use of any product or circuit.

WILLAS products are not designed, intended or authorized for use in medical, life-saving implant or other applications intended for life-sustaining or other related applications where a failure or malfunction of component or circuitry may directly or indirectly cause injury or threaten a life without expressed written approval of WILLAS. Customers using or selling WILLAS components for use in such applications do so at their own risk and shall agree to fully indemnify WILLAS Inc and its subsidiaries harmless against all claims, damages and expenditures.