

SF161CT THRU SF168CT

GLASS PASSIVATED SUPER FAST RECTIFIER
Reverse Voltage – 50 to 800 V
Forward Current – 16 A

Features

- Low forward voltage drop
- Low reverse leakage current
- Superfast switching time for high efficiency
- High current capability
- High surge current capability

Mechanical Data

- Case: Molded plastic, TO-220
- Epoxy: UL 94V-0 rate flame retardant
- Terminals: leads solderable per MIL-STD-202 method 208 guaranteed
- Polarity: As marked
- Mounting Position: Any

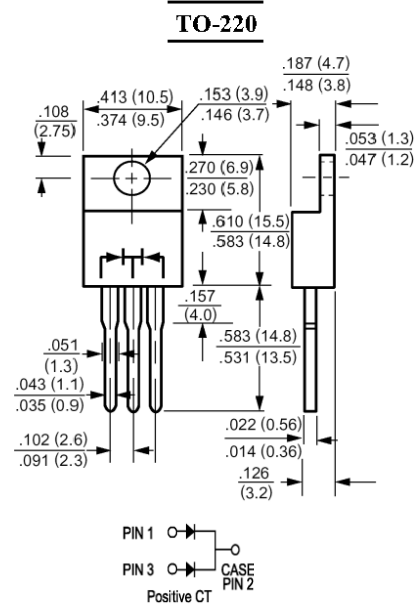

Dimensions in inches and (millimeters)

Absolute Maximum Ratings and Characteristics

Ratings at 25 °C ambient temperature unless otherwise specified. Single phase, half wave, 60 Hz, resistive or inductive load. For capacitive load, derate current by 20%.

Parameter	Symbols	SF161CT	SF162CT	SF163CT	SF164CT	SF165CT	SF166CT	SF167CT	SF168CT	Units
Maximum Recurrent Peak Reverse Voltage	V_{RRM}	50	100	150	200	300	400	500	600	V
Maximum RMS Voltage	V_{RMS}	35	70	105	140	210	280	350	420	V
Maximum DC Blocking Voltage	V_{DC}	50	100	150	200	300	400	500	600	V
Maximum Average Forward Rectified Current at $T_C = 100^\circ\text{C}$	$I_{(AV)}$	16								A
Peak Forward Surge Current, 8.3 ms Single half Sine-wave Superimposed on Rated Load (JEDEC method)	I_{FSM}	125								A
Maximum Forward Voltage at 8 A and 25 °C	V_F	0.95			1.3		1.7			V
Maximum Reverse Current at $T_A = 25^\circ\text{C}$ at Rated DC Blocking Voltage $T_A = 100^\circ\text{C}$	I_R	10 500								μA
Typical Junction Capacitance ¹⁾	C_J	80			60					pF
Maximum Reverse Recovery Time ²⁾	t_{rr}	35			50					ns
Typical Thermal Resistance ³⁾	$R_{\theta JC}$	2.5								$^\circ\text{C}/\text{W}$
Operating and Storage Temperature Range	T_J, T_s	-55 to +150								$^\circ\text{C}$

¹⁾ Measured at 1 MHz and applied reverse voltage of 4 VDC.

²⁾ Reverse recovery test conditions: $I_F = 0.5 \text{ A}$, $I_R = 1 \text{ A}$, $I_{RR} = 0.25 \text{ A}$

³⁾ Thermal resistance from Junction to case per leg mounted on heatsink.

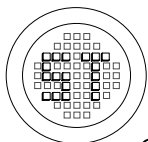

SEMTECH ELECTRONICS LTD.
 (Subsidiary of Semtech International Holdings Limited, a company listed on the Hong Kong Stock Exchange, Stock Code: 724)



SF161CT THRU SF168CT

FIG.1- REVERSE RECOVERY TIME CHARACTERISTIC AND TEST CIRCUIT DIAGRAM

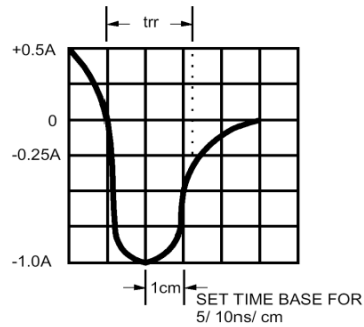
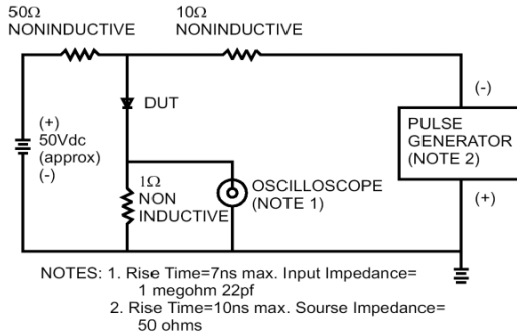

FIG.2- MAXIMUM FORWARD CURRENT DERATING CURVE

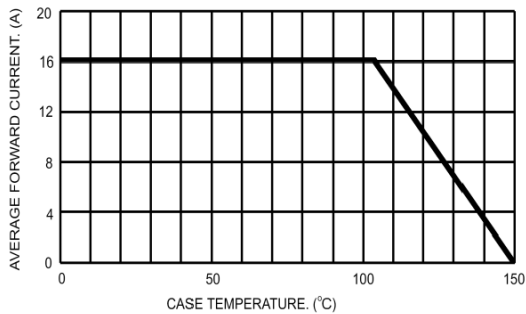

FIG.3- TYPICAL REVERSE CHARACTERISTICS

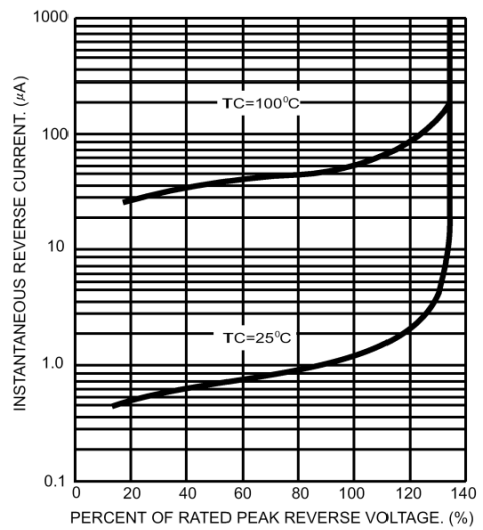

FIG.4- MAXIMUM NON-REPETITIVE FORWARD SURGE CURRENT PER LEG

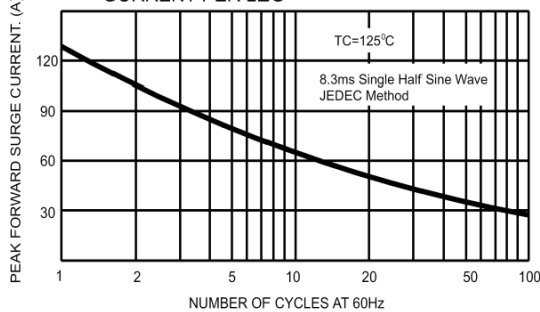

FIG.6- TYPICAL FORWARD CHARACTERISTICS PER LEG

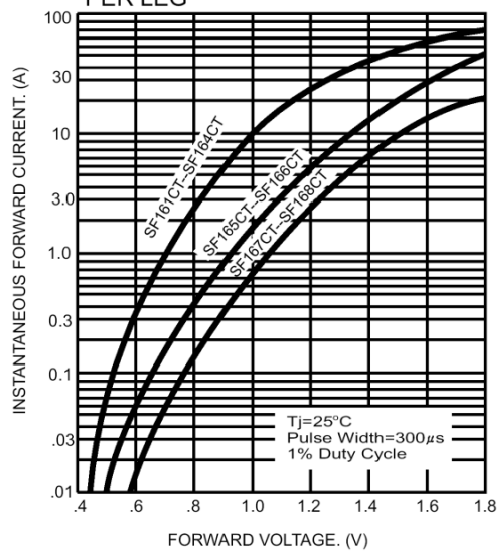
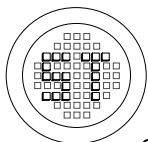
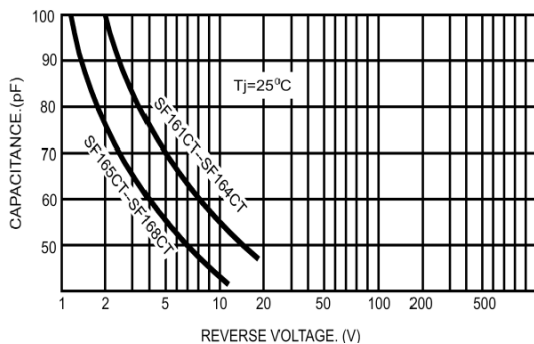

FIG.5- TYPICAL JUNCTION CAPACITANCE PER LEG



SEMTECH ELECTRONICS LTD.

(Subsidiary of Semtech International Holdings Limited, a company listed on the Hong Kong Stock Exchange, Stock Code: 724)



ISO/TS 16949 : 2002
Certificate No. 05103

ISO 14001:2004
Certificate No. 7116

ISO 9001:2000
Certificate No. 0506098