

### Dual IGBTMOD™ Compact IGBT Series Module 400 Amperes/1200 Volts

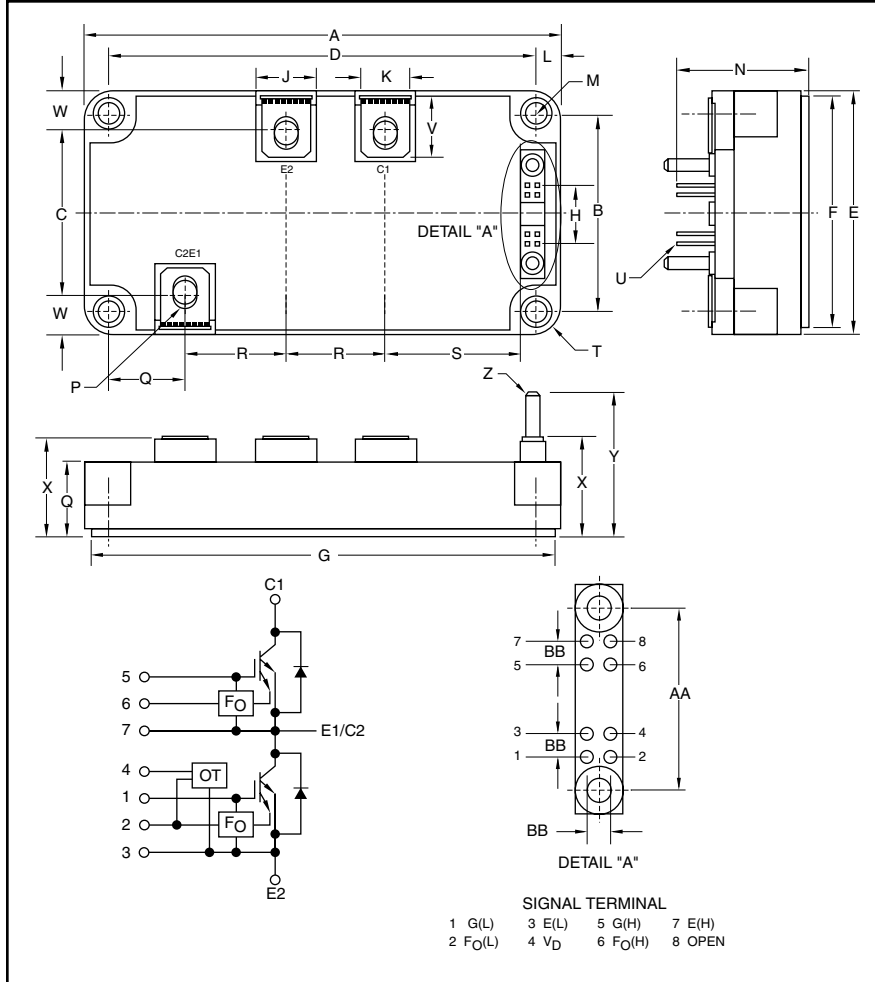

#### Description:

Powerex Dual IGBTMOD™ Compact IGBT Series Modules are designed for use in switching applications. Each module consists of two IGBT Transistors in a half-bridge configuration, with each transistor having a reverse-connected super-fast recovery free-wheel diode. All components and interconnects are isolated from the heat sinking baseplate, offering simplified system assembly and thermal management.

#### Features:

- Over-Current and Over-Temperature Protection
- Low V<sub>CE(sat)</sub>
- Isolated Baseplate for Easy Heat Sinking

#### Applications:

- AC Motor Control
- Motion/Servo Control
- UPS
- Welding Power Supplies
- Laser Power Supplies

#### Ordering Information:

Example: Select the complete part number from the table below -i.e. MG400Q2YS60A is a 1200V (V<sub>CES</sub>), 400 Ampere Dual IGBTMOD™ Compact IGBT Series Module.

Type	Current Rating Amperes	V <sub>CES</sub> Volts (x 20)
MG	400	60

#### Outline Drawing and Circuit Diagram

Dimensions	Inches	Millimeters
A	4.80±0.04	122.0±1.0
B	1.97±0.01	50.0±0.3
C	1.61±0.03	41.0±0.8
D	4.33±0.01	110.0±0.3
E	2.44±0.04	62.0±1.0
F	2.32±0.02	59.0±0.5
G	4.69±0.02	119.0±0.5
H	0.60	15.24
J	0.63	16.0
K	0.51	13.0
L	0.24	6.0
M	0.22 Dia.	5.5 Dia.
N	1.42±0.03	36.0±0.8

Dimensions	Inches	Millimeters
P	M6	M6
Q	0.79±0.03	20.0±0.8
R	1.02±0.03	26.0±0.8
S	1.44±0.03	36.7±0.8
T	0.24 Rad.	6.0 Rad.
U	0.02	0.64
V	0.60	15.3
W	0.41±0.03	10.5±0.8
X	1.02 -0.01/+0.04	26.0-0.3/+1.0
Y	1.48 -0.02/+0.04	37.5-0.5/+1.0
Z	0.01 Dia.	3.0 Dia.
AA	1.00±0.023	25.4±0.6
BB	0.10	2.54



Powerex, Inc., 200 E. Hillis Street, Youngwood, Pennsylvania 15697-1800 (724) 925-7272

**MG400Q2YS60A**  
**Dual IGBTMOD™**  
**Compact IGBT Series Module**  
 400 Amperes/1200 Volts

**Absolute Maximum Ratings,  $T_j = 25^\circ\text{C}$  unless otherwise specified**

Characteristics	Symbol	MG400Q2YS60A	Units
Power Device Junction Temperature	$T_j$	-20 to 150	$^\circ\text{C}$
Storage Temperature	$T_{\text{stg}}$	-40 to 125	$^\circ\text{C}$
Operating Temperature Range	$T_{\text{ope}}$	-20 ~ 100	$^\circ\text{C}$
Mounting Torque, M5 Mounting Screws	—	31	in-lb
Mounting Torque, M6 Main Terminal Screws	—	40	in-lb
Module Weight (Typical)	—	375	Grams
Isolation Voltage, AC 1 minute, 60Hz Sinusoidal	$V_{\text{ISO}}$	2500	Volts

**IGBT Inverter Sector**

Collector-Emitter Voltage	$V_{\text{CES}}$	1200	Volts
Gate-Emitter Voltage	$V_{\text{GES}}$	$\pm 20$	Volts
Collector Current ( $T_C = 25^\circ\text{C}$ )	$I_C$	400	Amperes
Peak Collector Current ( $T_C = 25^\circ\text{C}$ )	$I_{\text{CP}}$	800	Amperes
Emitter Current ( $T_C = 25^\circ\text{C}$ )	$I_E$	400	Amperes
Peak Emitter Current ( $T_C = 25^\circ\text{C}$ )	$I_{\text{EM}}$	800	Amperes
Collector Dissipation ( $T_C = 25^\circ\text{C}$ )	$P_C$	3750	Watts

**IGBT Control Sector**

Control Voltage (OT)	$V_D$	20	Volts
Fault Input Voltage	$V_{\text{FO}}$	20	Volts
Fault Input Current	$I_{\text{FO}}$	20	mA

**Electrical and Mechanical Characteristics,  $T_j = 25^\circ\text{C}$  unless otherwise specified**

Characteristics	Symbol	Test Conditions	Min.	Typ.	Max.	Units
Gate Leakage Current	$I_{\text{GES}}$	$V_{\text{GE}} = \pm 20\text{V}, V_{\text{CE}} = 0\text{V}$	—	—	-4 / +3	mA
		$V_{\text{GE}} = 10\text{V}, V_{\text{CE}} = 0\text{V}$	—	—	100	nA
Collector-Emitter Cutoff Current	$I_{\text{CES}}$	$V_{\text{CE}} = 1200\text{V}, V_{\text{GE}} = 0\text{V}$	—	—	1.0	mA
Gate-Emitter Cutoff Voltage	$V_{\text{GE(off)}}$	$V_{\text{CE}} = 5\text{V}, I_C = 400\text{mA}$	6.0	7.0	8.0	Volts
Collector-Emitter Saturation Voltage	$V_{\text{CE(sat)}}$	$V_{\text{GE}} = 15\text{V}, I_C = 400\text{A}, T_j = 25^\circ\text{C}$	—	2.4	2.8	Volts
		$V_{\text{GE}} = 15\text{V}, I_C = 400\text{A}, T_j = 125^\circ\text{C}$	—	—	3.2	Volts
Input Capacitance	$C_{\text{ies}}$	$V_{\text{CE}} = 10\text{V}, V_{\text{GE}} = 0\text{V}, f = 1\text{MHz}$	—	31,000	—	pF
Inductive Load	$t_{\text{d(on)}}$		0.1	—	1.0	$\mu\text{s}$
Switching Times	$t_{\text{off}}$	$V_{\text{CC}} = 600\text{V}, I_C = 400\text{A}, V_{\text{GE}} = \pm 15\text{V}, R_G = 5.1\Omega$	—	—	2.0	$\mu\text{s}$
			—	—	0.5	$\mu\text{s}$
Reverse Recovery Time	$t_{\text{rr}}$		—	—	0.5	$\mu\text{s}$
Emitter-Collector Voltage	$V_{\text{EC}}$	$I_E = 400\text{A}$	—	2.4	2.8	Volts



Powerex, Inc., 200 E. Hillis Street, Youngwood, Pennsylvania 15697-1800 (724) 925-7272

**MG400Q2YS60A**  
**Dual IGBTMOD™**  
**Compact IGBT Series Module**  
**400 Amperes/1200 Volts**

**Electrical and Mechanical Characteristics,  $T_j = 25^\circ\text{C}$  unless otherwise specified**

Characteristics	Symbol	Test Conditions	Min.	Typ.	Max.	Units
<b>Control Sector</b>						
Fault Output Current	$O_C$	$V_{GE} = 15\text{V}$	480	—	—	A
Over-Temperature	$O_T$	—	100	—	125	$^\circ\text{C}$
Fault Output Delay Time	$t_d(\text{Fo})$	$V_{CC} = 600\text{V}, V_{GE} = \pm 15\text{V}$	—	—	8	$\mu\text{s}$

**Thermal Characteristics**

Characteristic	Symbol	Condition	Min.	Typ.	Max.	Units
Junction to Case Thermal Resistance	$R_{th(j-c)Q}$	IGBT (Per 1/2 Module)	—	—	0.033	$^\circ\text{C/Watt}$
	$R_{th(j-c)D}$	FWDi (Per 1/2 Module)	—	—	0.068	$^\circ\text{C/Watt}$
Contact Thermal Resistance	$R_{th(c-f)}$	—	—	0.013	—	$^\circ\text{C/Watt}$

**Recommended Conditions for Use**

Characteristic	Symbol	Condition	Value	Units
Supply Voltage	$V_{CC}$	Applied across C1-E2 Terminals	$\leq 750$	Volts
Gate Voltage	$V_{GE}$	—	14.8 ~ 17	Volts
Gate Resistance	$R_G$	—	$\geq 10.0$	$\Omega$
Switching Frequency	$f_C$	—	0 ~ 20	kHz

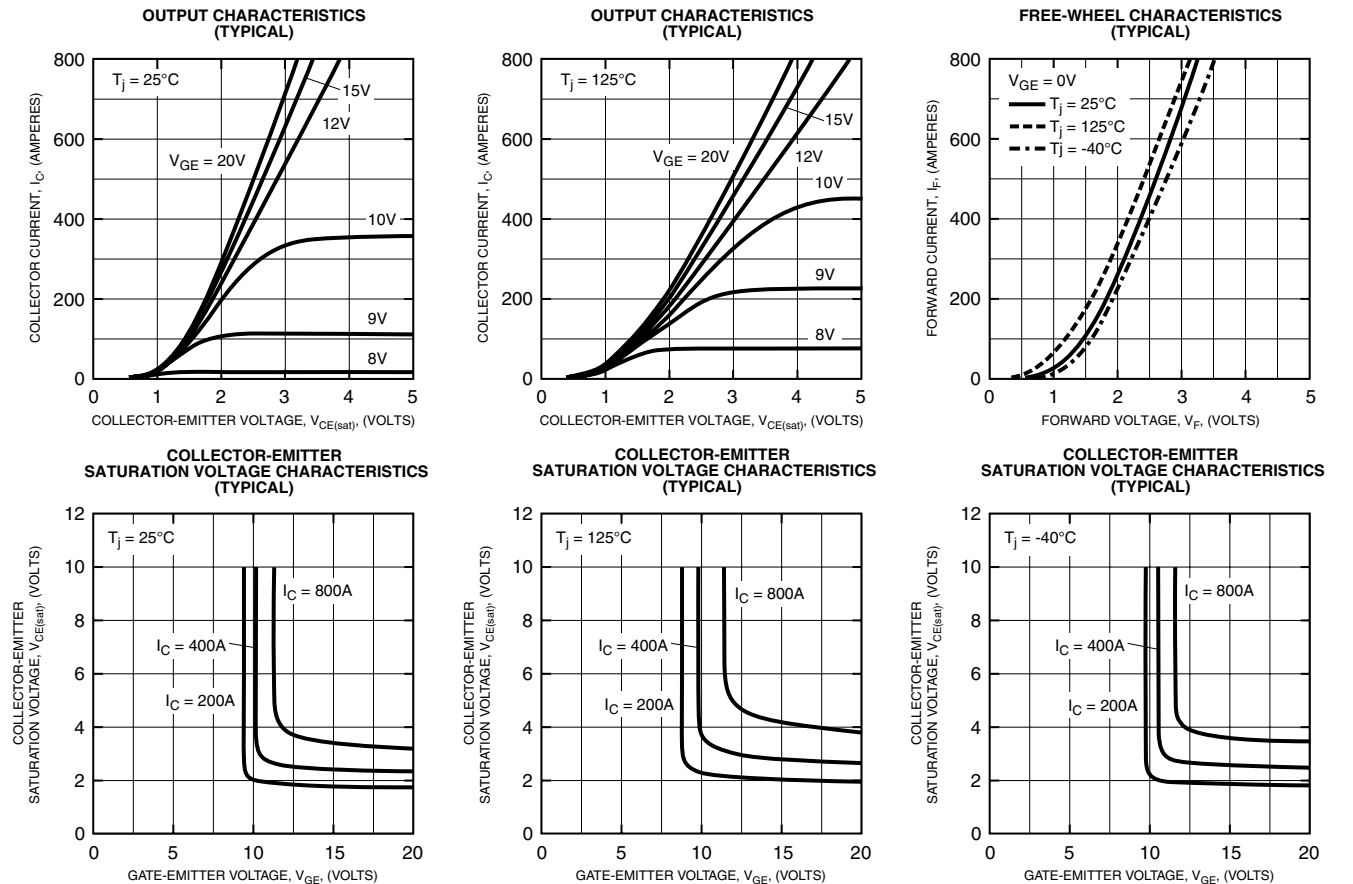



Powerex, Inc., 200 E. Hillis Street, Youngwood, Pennsylvania 15697-1800 (724) 925-7272

**MG400Q2YS60A**  
**Dual IGBTMOD™**  
**Compact IGBT Series Module**  
**400 Amperes/1200 Volts**

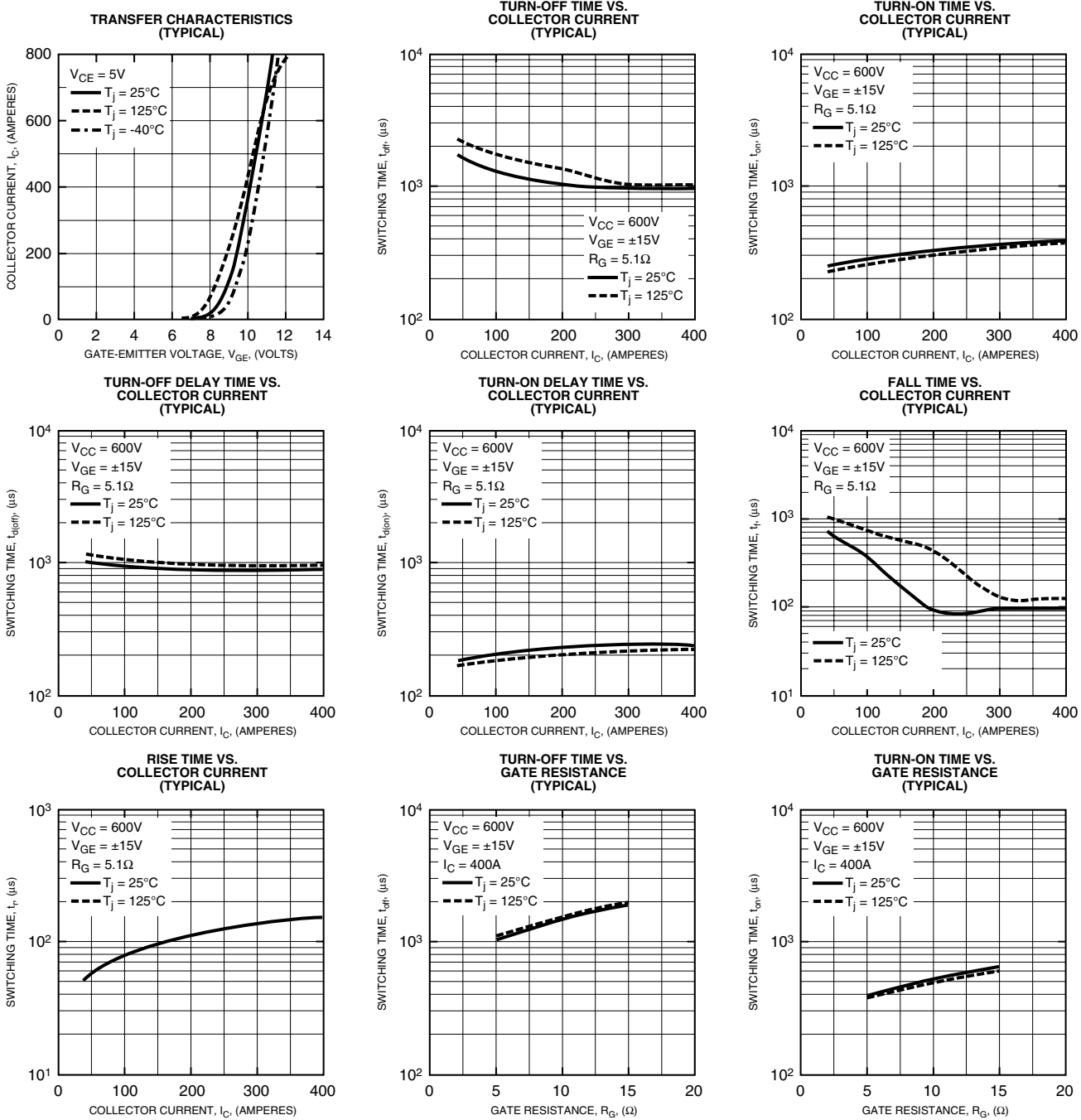

**MG400Q2YS60A**  
**Dual IGBTMOD™**  
**Compact IGBT Series Module**  
 400 Amperes/1200 Volts

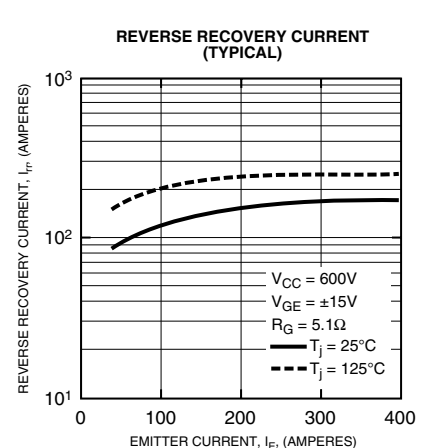
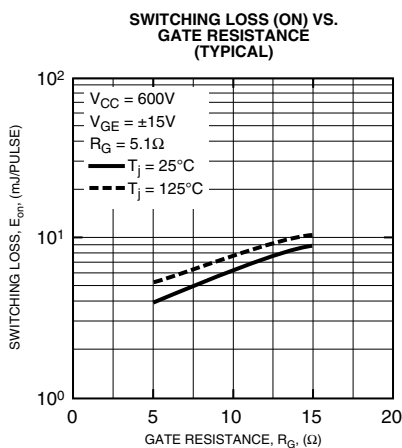
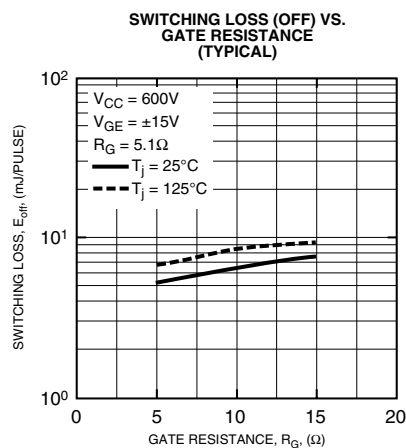
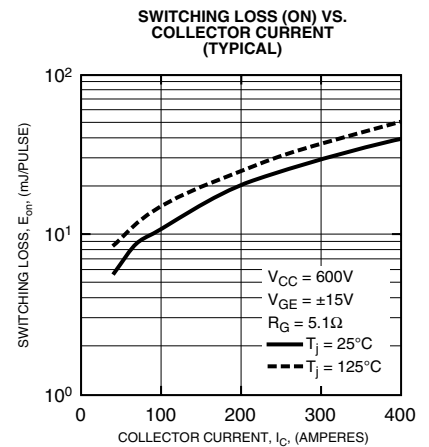
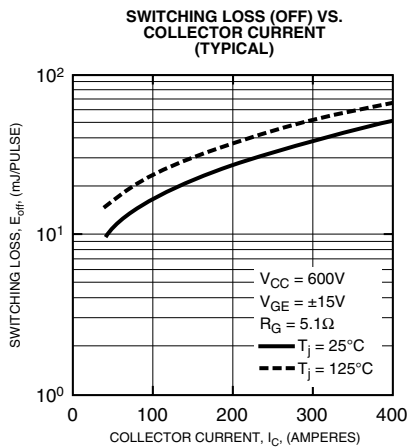
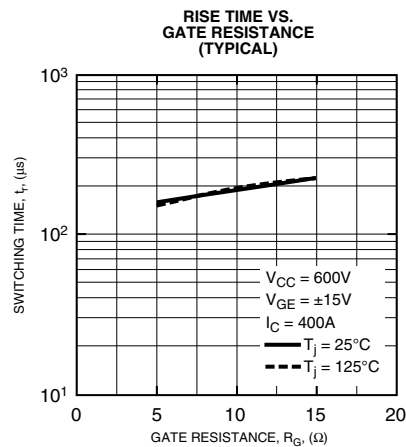
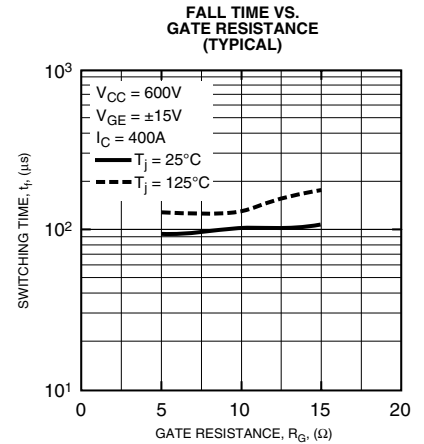
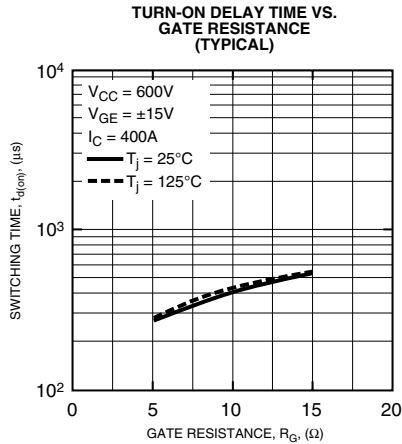
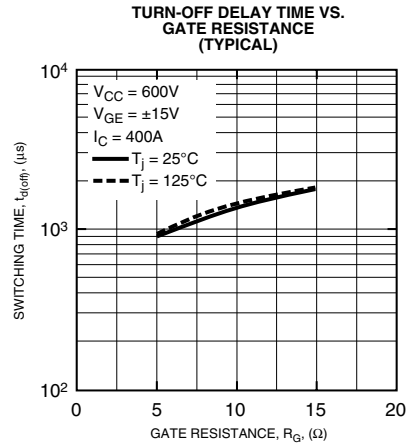



Powerex, Inc., 200 E. Hillis Street, Youngwood, Pennsylvania 15697-1800 (724) 925-7272

**MG400Q2YS60A**  
**Dual IGBTMOD™**  
**Compact IGBT Series Module**  
**400 Amperes/1200 Volts**

