

# LF 1608 Series

Multilayer Chip Low-Pass Filters

## Features

- ❖ Monolithic structure replacing one inductor and three capacitors.
- ❖ RoHS compliant

## Applications

- ❖ 0.5-6GHz wireless communication systems, including DECT / PACS / PHS / GSM / DCS / PCS phones, WLAN card, Bluetooth modules, etc.



## Specifications

Part Number	Freq. Range (MHz)	Insertion Loss @ BW (dB)	VSWR @ BW	Frequency (MHz)	Attenuation (dB)
<b>LF1608-LR63KAA_</b>	470~ 787	0.65 max. @25°C 0.71 max. @-40~85°C	1.5 max.	1429~1501	26 min.
				1554~1574	35 min.
				1580~1607	30 min.
				1920~1980	20 min.

Q'ty/Reel (pcs) : 4,000  
 Operating Temperature Range : -40 ~ +85 °C  
 Storage Temperature Range : -40 ~ +85 °C  
 Storage Period : 12 months max.\*  
 \*12 months in vacuum sealed bag and 1 week after opened. Please keep unused parts in vacuum sealed bags.  
 Solder Paste : SAC 305 type is recommended.  
 Power Capacity : 2W max.

## Part Number

LF   1608   -   L   R63   KAA   □   /LF  
 ①   ②   ③   ④   ⑤   ⑥   ⑦

① Type	LF : Low Pass Filter	② Dimensions ( L x W )	1.6 x 0.8 mm
③ Material Code	L	④ Frequency Range	R63=630MHz
⑤ Specification Code	KAA	⑥ Packaging	T: Tape & Reel B: Bulk
⑦ Soldering	/LF=lead-free		

## Terminal Configuration

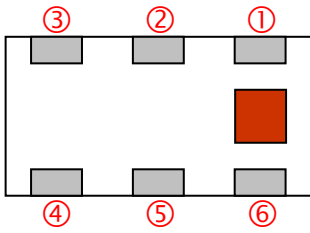

No.	Terminal Name	No.	Terminal Name
①	GND	④	OUT
②	NC	⑤	GND
③	GND	⑥	IN

## Dimensions and Recommended PC Board Pattern

Unit : mm

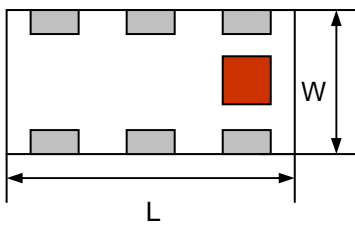

< Top View >

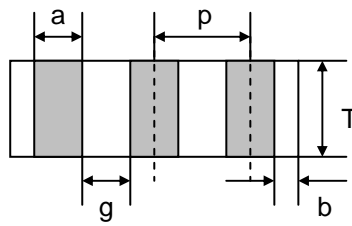

< Side View >

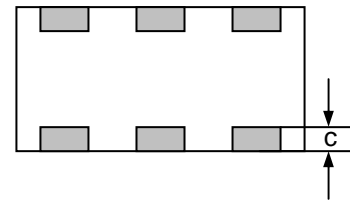

< Bottom View >

Mark	L	W	T	a	b	c	g	p
Dimensions	1.6 ±	0.8 ±	0.6 ±	0.2 ±	0.2+0.1	0.15 ±	0.3 ±	0.50 ±
	0.1	0.1	0.1	0.1	-0.15	0.1	0.1	0.05

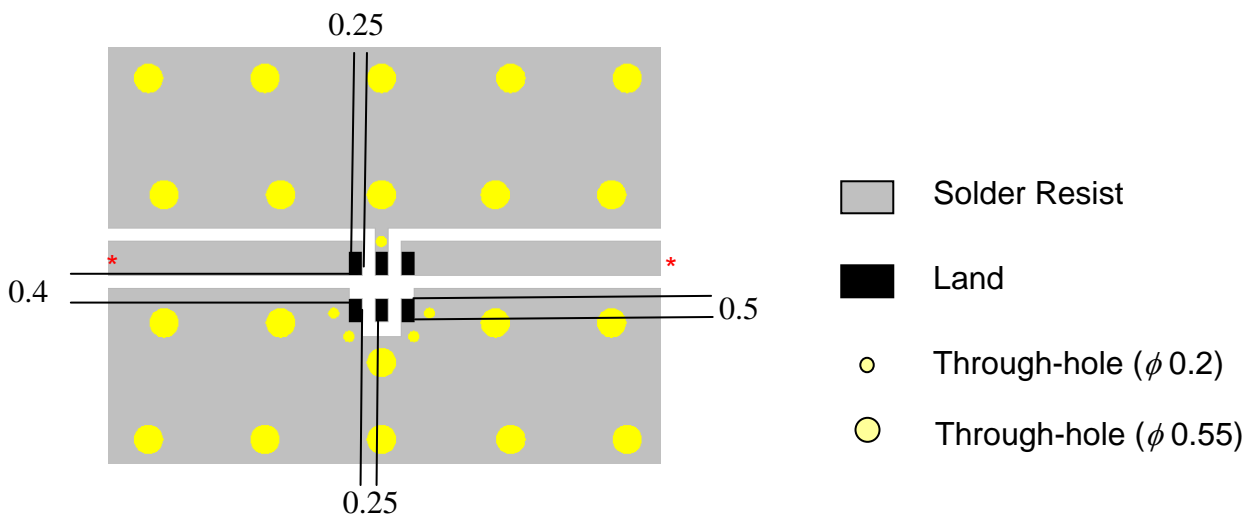

\* Line width should be designed to match 50 Ω characteristic impedance, depending on PCB material and thickness.

## Measuring Diagram

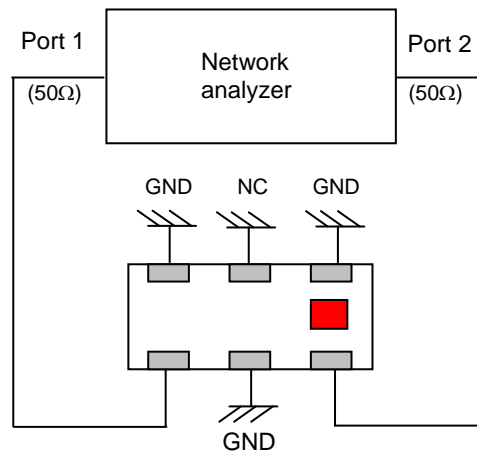

## Typical Electrical Characteristics (T=25°C)

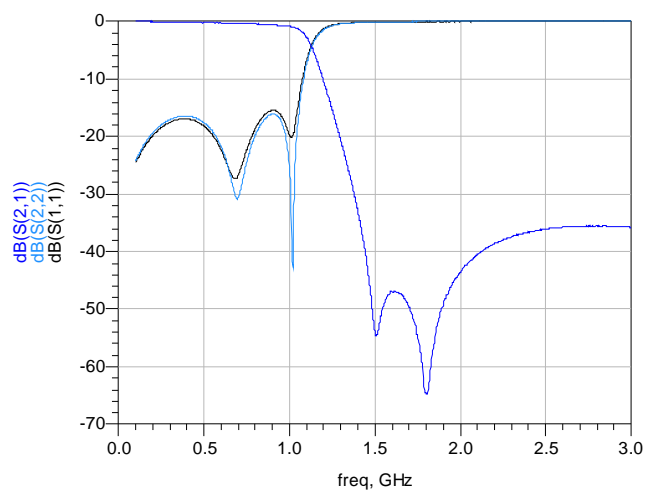

## Notes

- ❖ The contents of this data sheet are subject to change without notice. Please confirm the specifications and delivery conditions when placing your order.

## Taping Specifications

### ❖Tape Dimensions (Unit: mm) & Quantity

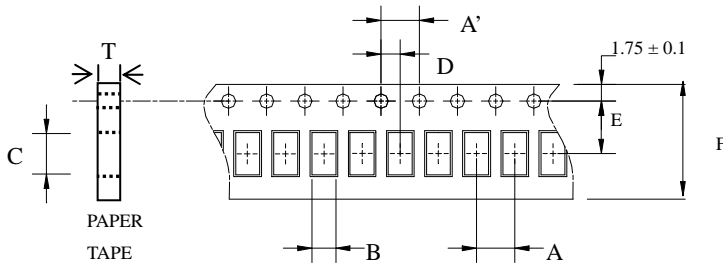

Type	A	A'	B	C	D	E	F	T	Quantity/reel	Tape material
1608	4.0±	4.0±	1.10±	1.92±	2.0±	3.5±	8.0±	0.75±	4,000pcs	Paper
	0.1	0.1	0.1	0.1	0.1	0.1	0.1	0.05		

### ❖Reel Dimensions (Unit: mm)

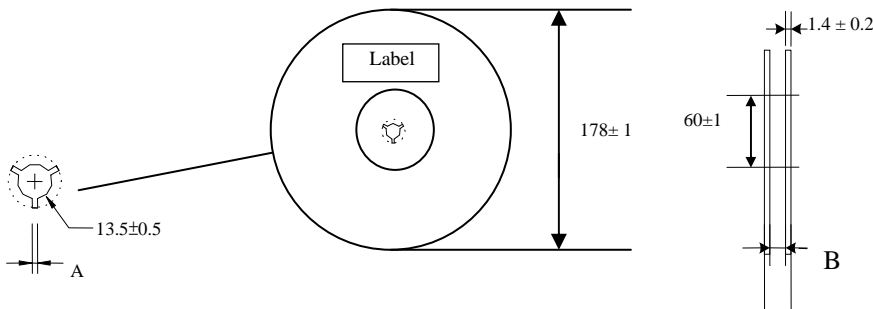

Label: Customer's Name,  
ACX P/N, Q'ty, Date,  
ACX Corp.

Type	A	B
1608	2.3±0.5	9.0±0.3

### ❖Leader and Trailer Tape

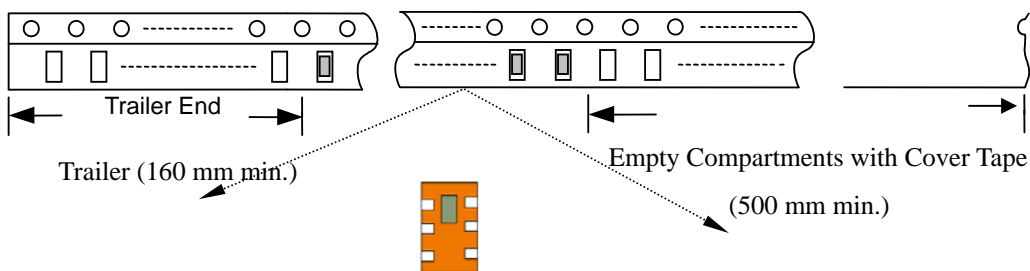

❖ **Peel-off Force**

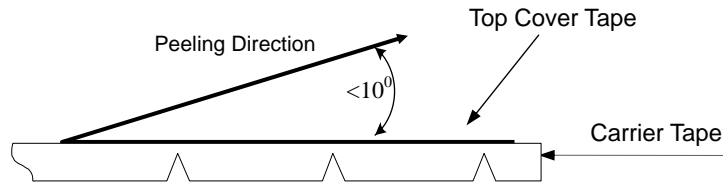

Peel-off force should be in the range of 0.1 – 0.6 N at a peel-off speed of  $300 \pm 10$  mm/min .

❖ **Storage Conditions**

- (1) Temperature:  $5 \sim 35^{\circ}\text{C}$ , relative humidity (RH): 45~75%.
- (2) Non-corrosive environment.

**Notes**

- ❖ The contents of this data sheet are subject to change without notice. Please confirm the specifications and delivery conditions when placing your order.

## Mechanical & Environmental Characteristics

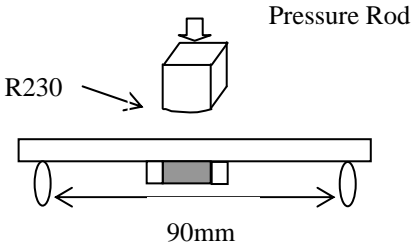
Item	Requirements	Procedure
Solderability	<ol style="list-style-type: none"> <li>No apparent damage</li> <li>More than 75% of the terminal electrode shall be covered with new solder.</li> </ol>	<ol style="list-style-type: none"> <li>Preheat: <math>120 \pm 5^{\circ}\text{C}</math></li> <li>Solder: <math>245 \pm 5^{\circ}\text{C}</math> for <math>5 \pm 1</math> sec</li> </ol>
Soldering strength (Termination Adhesion)	<ol style="list-style-type: none"> <li>1kg minimum</li> </ol>	<ol style="list-style-type: none"> <li>Solder specimen onto test jig.</li> <li>Apply push force at 0.5mm/s until electrode pads are peeled off or ceramic are broken. Pushing force is applied to longitude direction.</li> </ol>
Deflection (Substrate Bending)	<ol style="list-style-type: none"> <li>No apparent damage</li> <li>Fulfill the electrical specification</li> </ol>	<ol style="list-style-type: none"> <li>Solder specimen onto test jig (FR4, 0.8mm) using the recommend soldering profile.</li> <li>Apply a bending force of 2mm deflection</li> </ol> 
Heat/Humidity Resistance	<ol style="list-style-type: none"> <li>No apparent damage</li> <li>Fulfill the electrical specification after test</li> </ol>	<ol style="list-style-type: none"> <li>Temperature: <math>85 \pm 2^{\circ}\text{C}</math></li> <li>Humidity: 90% ~ 95% RH</li> <li>Duration: <math>1000 \pm 48</math>hrs</li> <li>Recovery: 1-2hrs</li> </ol>
Thermal shock (Temperature Cycle)	<ol style="list-style-type: none"> <li>No apparent damage</li> <li>Fulfill the electrical specification after test</li> </ol>	<ol style="list-style-type: none"> <li>One cycle/step 1 : <math>125 \pm 5^{\circ}\text{C}</math> for 30 min step 2 : <math>-40 \pm 5^{\circ}\text{C}</math> for 30 min</li> <li>No of cycles : 100</li> <li>Recovery: 1-2 hrs</li> </ol>
Low Temperature Resistance	<ol style="list-style-type: none"> <li>No apparent damage</li> <li>Fulfill the electrical specification after test</li> </ol>	<ol style="list-style-type: none"> <li>Temperature: <math>-40 \pm 5^{\circ}\text{C}</math></li> <li>Duration: <math>500 \pm 24</math>hrs</li> <li>Recovery: 1-2hrs</li> </ol>

## Soldering Conditions

### ❖ Typical Soldering Profile for Lead-free Process

Reflow Soldering :

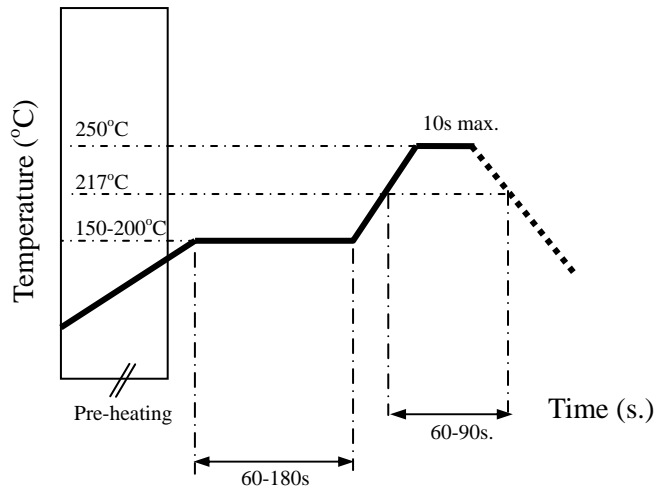

## Notes

❖ The contents of this data sheet are subject to change without notice. Please confirm the specifications and delivery conditions when placing your order.

### **Advanced Ceramic X Corp.**

16 Tzu Chiang Road, Hsinchu Industrial District Hsinchu Hsien 303, Taiwan

TEL:886-3-5987008 FAX:886-3-5987001

E-mail: [acx@acxc.com.tw](mailto:acx@acxc.com.tw)

<http://www.acxc.com.tw>