

# AN6555, AN6556, AN6556S

## Low Noise Dual Operational Amplifiers

### Overview

The AN6555, the AN6556, and the AN6556S are low noise, high slew rate dual operational amplifiers with phase compensation circuits built-in.

They are suitable for applications to various electronic circuits such as active filters and audio preamplifiers.

### Features

- Phase compensation circuit
- High voltage gain:  $G_v=100$  dB typ.
- Low noise: input referred noise voltage  $V_{ni}=1.5\mu$  Vrms typ.
- High slew rate:  $SR=2V/\mu$  s typ.
- Output short-circuit protection

### Block Diagram

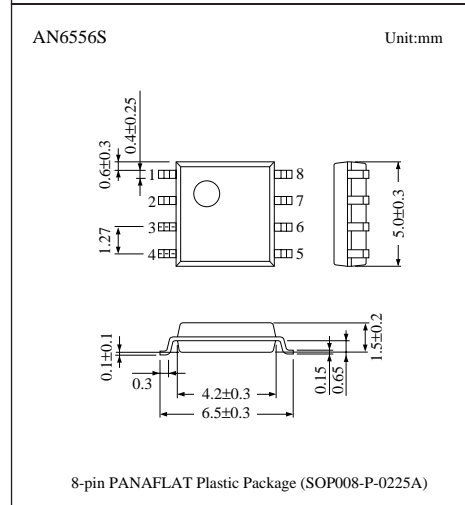
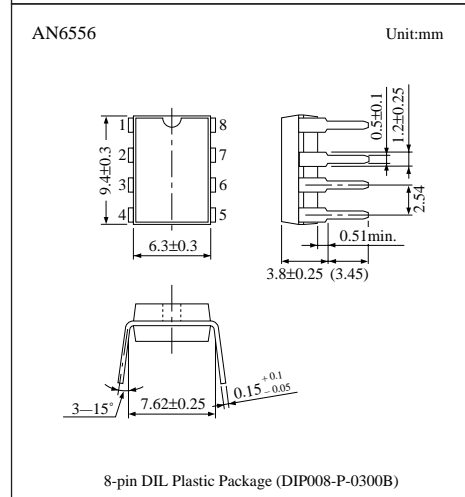
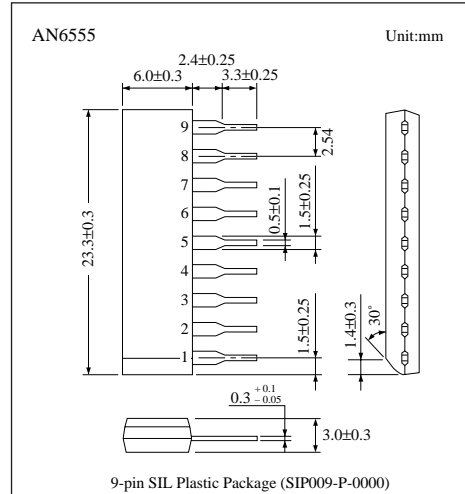
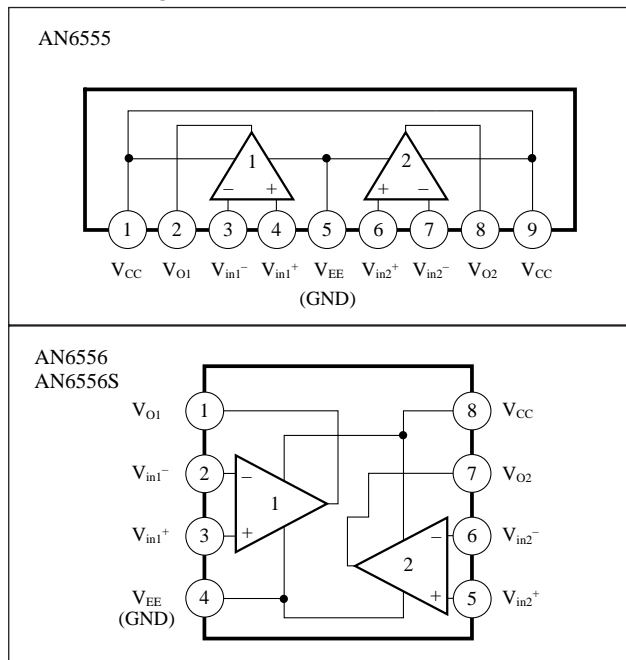

## ■ Pin Descriptions

〈AN6555〉

Pin No.	Pin name
1	V <sub>CC</sub>
2	Ch.1 output
3	Ch.1 inverting input
4	Ch.1 non inverting input
5	V <sub>EE</sub> (GND)
6	Ch.2 non inverting input
7	Ch.2 inverting input
8	Ch.2 output
9	V <sub>CC</sub>

〈AN6556, AN6556S〉

Pin No.	Pin name
1	Ch.1 output
2	Ch.1 inverting input
3	Ch.1 non inverting input
4	V <sub>EE</sub> (GND)
5	Ch.2 non inverting input
6	Ch.2 inverting input
7	Ch.2 output
8	V <sub>CC</sub>

## ■ Absolute Maximum Ratings (Ta=25°C)

Parameter		Symbol	Rating	Unit
Voltage	Supply voltage	V <sub>CC</sub>	±18	V
	Differential input voltage	V <sub>ID</sub>	±30	V
	Common-mode input voltage	V <sub>ICM</sub>	±15	V
Power dissipation	AN6555, AN6556	P <sub>D</sub>	500	mW
	AN6556S		360	
Operating ambient temperature		T <sub>opr</sub>	-20 to +75	°C
Storage temperature	AN6555, AN6556	T <sub>stg</sub>	-55 to +150	°C
	AN6556S		-55 to +125	

## ■ Electrical Characteristics (V<sub>CC</sub>=15V, V<sub>EE</sub>=-15V, Ta=25°C)

Parameter	Symbol	Condition	min	typ	max	Unit
Input offset voltage	V <sub>I (offset)</sub>	R <sub>S</sub> ≤ 10kΩ	—	0.5	6	mV
Input offset current	I <sub>IO</sub>		—	5	200	nA
Input bias current	I <sub>Bias</sub>		—	—	500	nA
Voltage gain	G <sub>V</sub>	R <sub>L</sub> ≥ 2kΩ, V <sub>O</sub> = ±10V	86	100	—	dB
Maximum output voltage	V <sub>O (max.)</sub>	R <sub>L</sub> ≥ 10kΩ	±12	±14	—	V
		R <sub>L</sub> ≥ 2kΩ	±10	±13	—	V
Common-mode input voltage width	V <sub>CM</sub>		±12	±14	—	V
Common-mode rejection ratio	CMR		70	90	—	dB
Supply voltage rejection ratio	SVR		—	30	150	μV/V
Power consumption	P <sub>C</sub>	R <sub>L</sub> = ∞	—	90	170	mW
Slew rate	SR	R <sub>L</sub> ≥ 2kΩ	—	2	—	V/μs
Equivalent input noise voltage	V <sub>ni</sub>	R <sub>S</sub> = 1kΩ, DIN/AUDIO	—	1.5	—	μV <sub>rms</sub>

## ■ Characteristics Curve

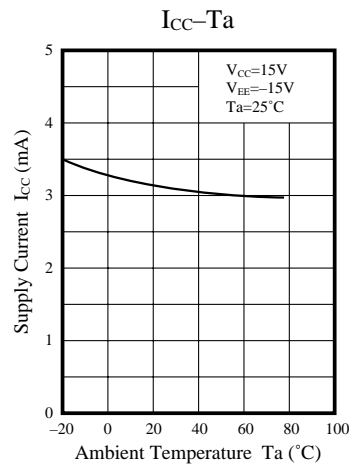
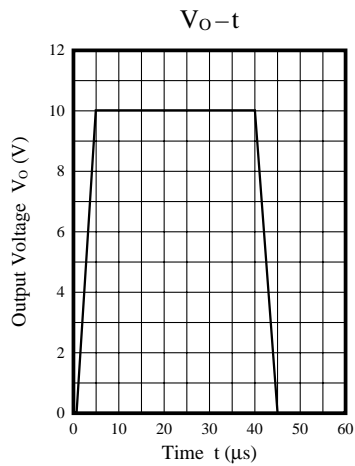
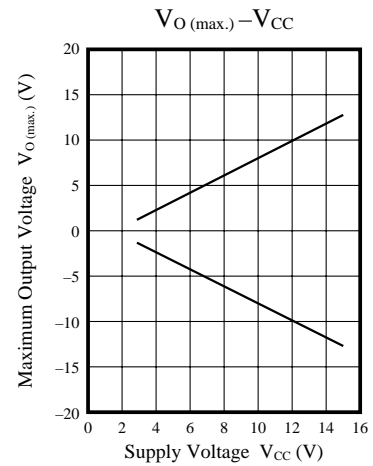
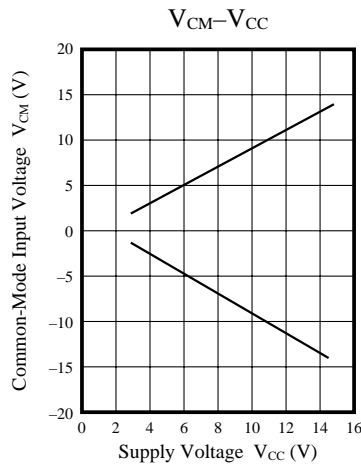
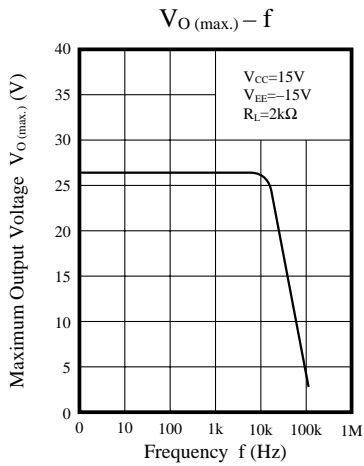
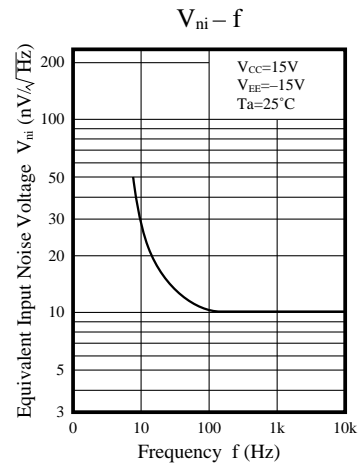
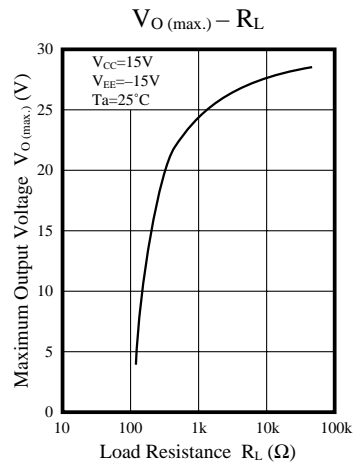
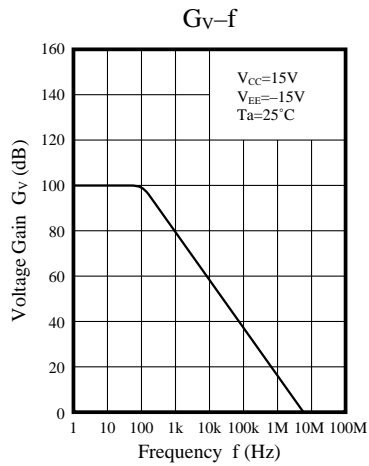

■ Application Circuit

