

SBD Type : C30T04Q

OUTLINE DRAWING

FEATURES

- *SQUARE-PAK TO-263AB(SMD)
- Packaged in 24mm Tape and Reel
- *Dual Diodes – Cathode Common
- *Low Forward Voltage Drop
- *High Surge Capability
- *T_j=150 °C operation

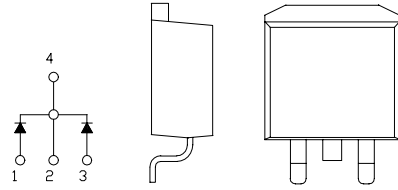

Maximum Ratings

Approx Net Weight: 1.4g

Rating	Symbol	C30T04Q			Unit
Repetitive Peak Reverse Voltage	V _{RRM}	40			V
Average Rectified Output Current	I _O	30	T _c =104°C	50 Hz Full Sine Wave Resistive Load	A
RMS Forward Current	I _{F(RMS)}	33.3			A
Surge Forward Current	I _{FSM}	250	50Hz Full Sine Wave ,1cycle Non-repetitive		A
Operating JunctionTemperature Range	T _{jw}	-40 to +150			°C
Storage Temperature Range	T _{stg}	-40 to +150			°C

Electrical • Thermal Characteristics

Characteristics	Symbol	Conditions	Min.	Typ.	Max.	Unit
Peak Reverse Current	I _{RM}	T _j = 25°C, V _{RM} = V _{RRM} per arm	-	-	15	mA
Peak Forward Voltage	V _{FM}	T _j = 25°C, I _{FM} = 15 A per arm	-	-	0.55	V
Thermal Resistance	R _{th(j-c)}	Junction to Case	-	-	1.5	°C /W

C_T_ OUTLINE DRAWING (Dimensions in mm)

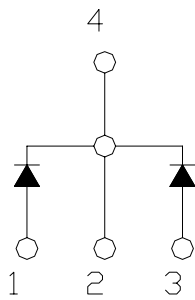
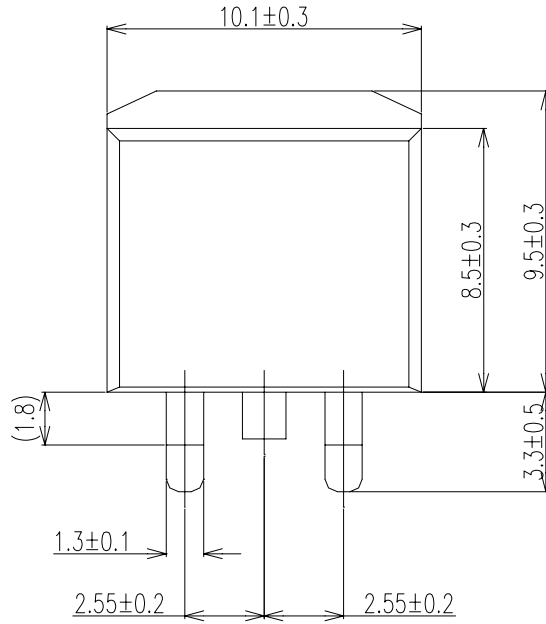
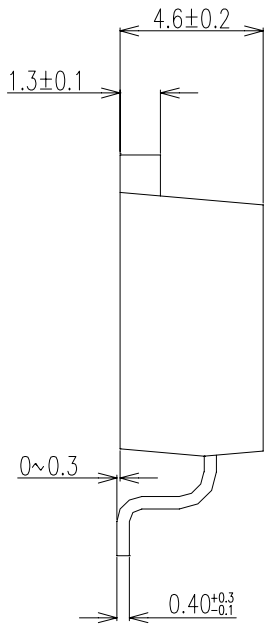

SOLDERING PAD

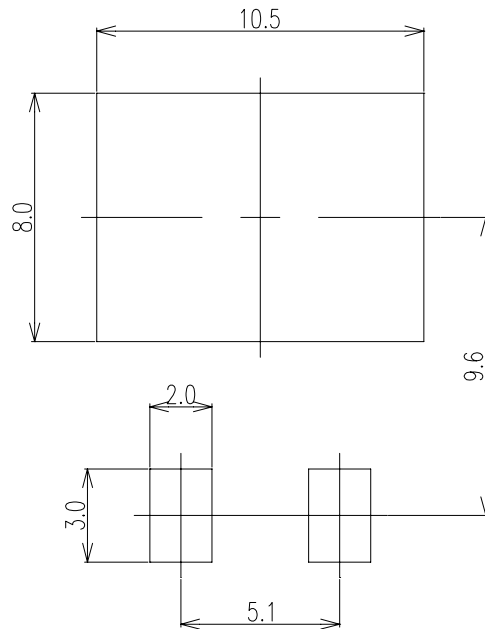

FORWARD CURRENT VS. VOLTAGE

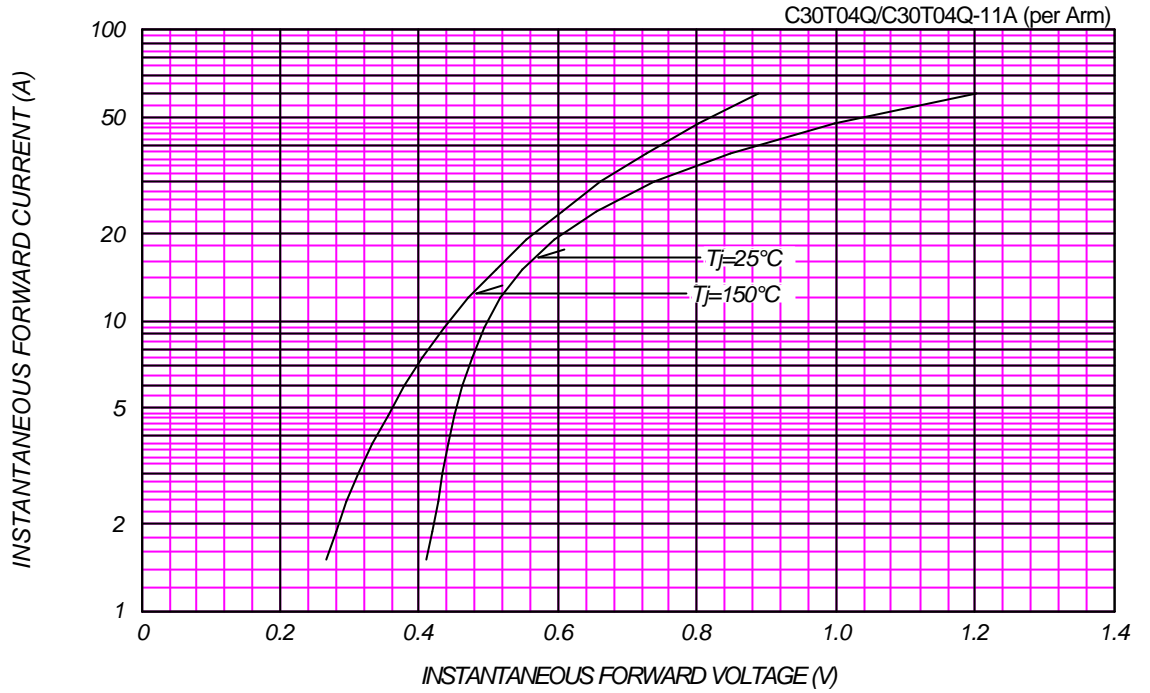

AVERAGE FORWARD POWER DISSIPATION

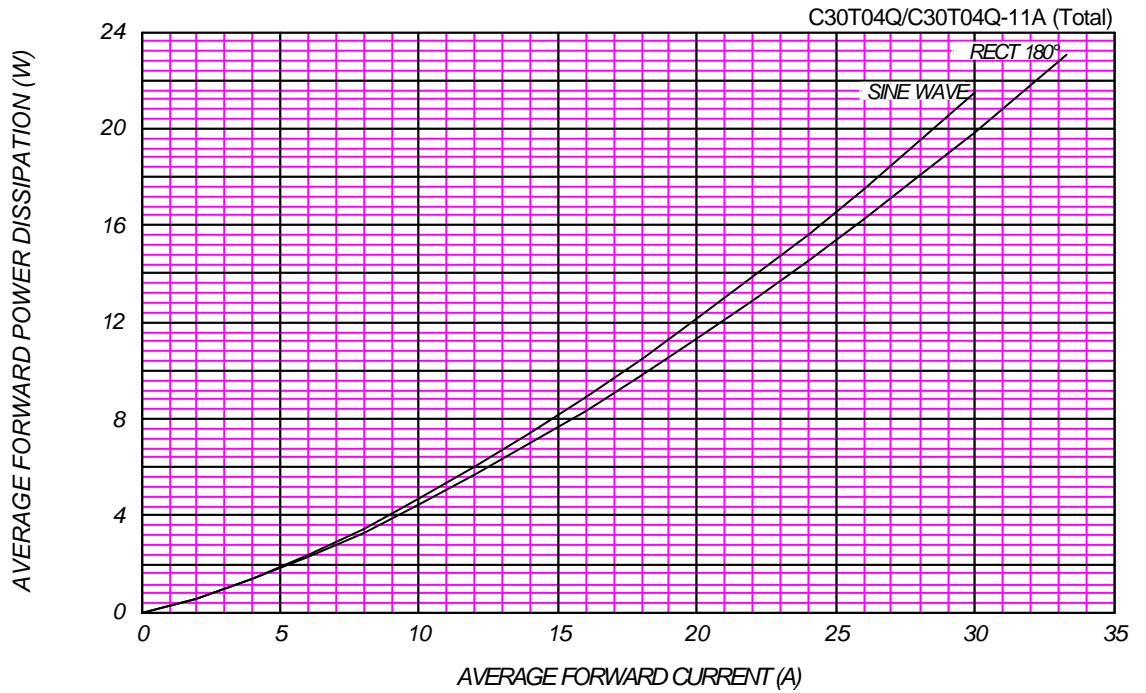

PEAK REVERSE CURRENT VS. PEAK REVERSE VOLTAGE

T_j = 150 °C

C30T04Q/C30T04Q-11A (per Arm)

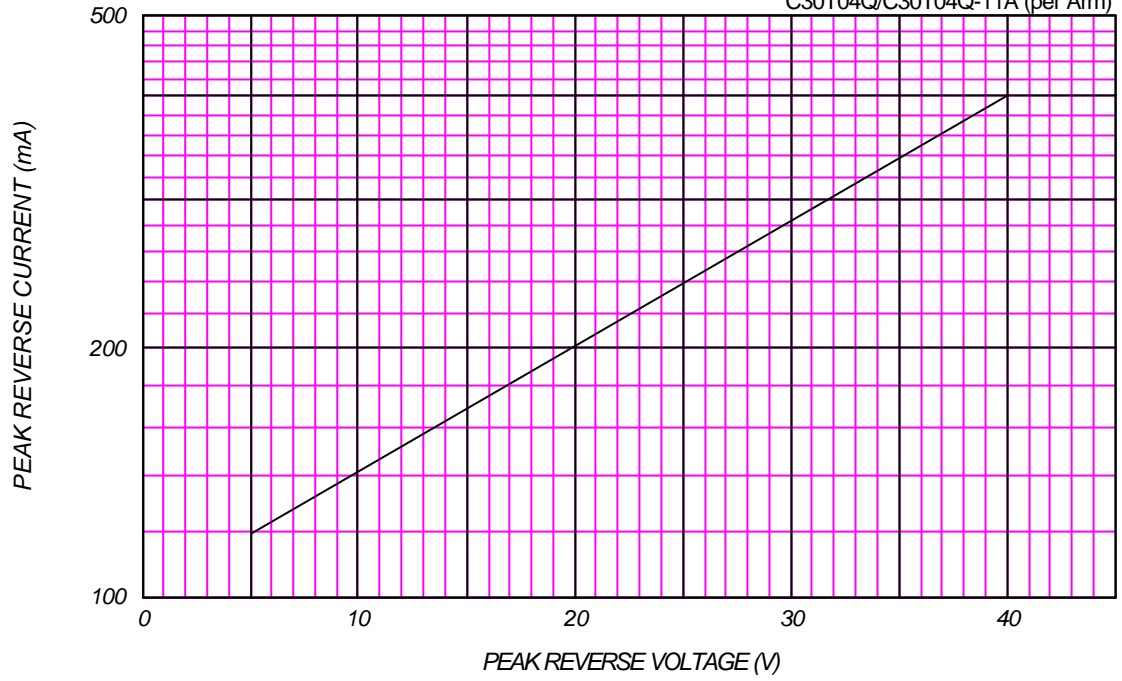

AVERAGE REVERSE POWER DISSIPATION

C30T04Q/C30T04Q-11A (Total)

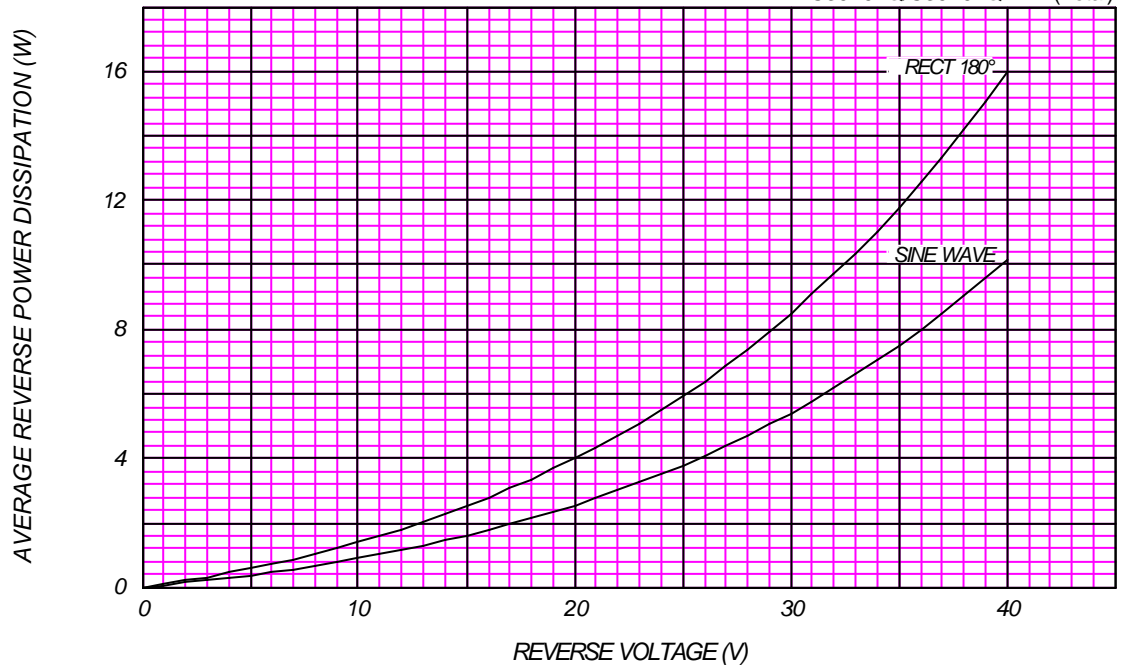



AVERAGE FORWARD CURRENT VS. CASE TEMPERATURE

$V_{RM}=40V$

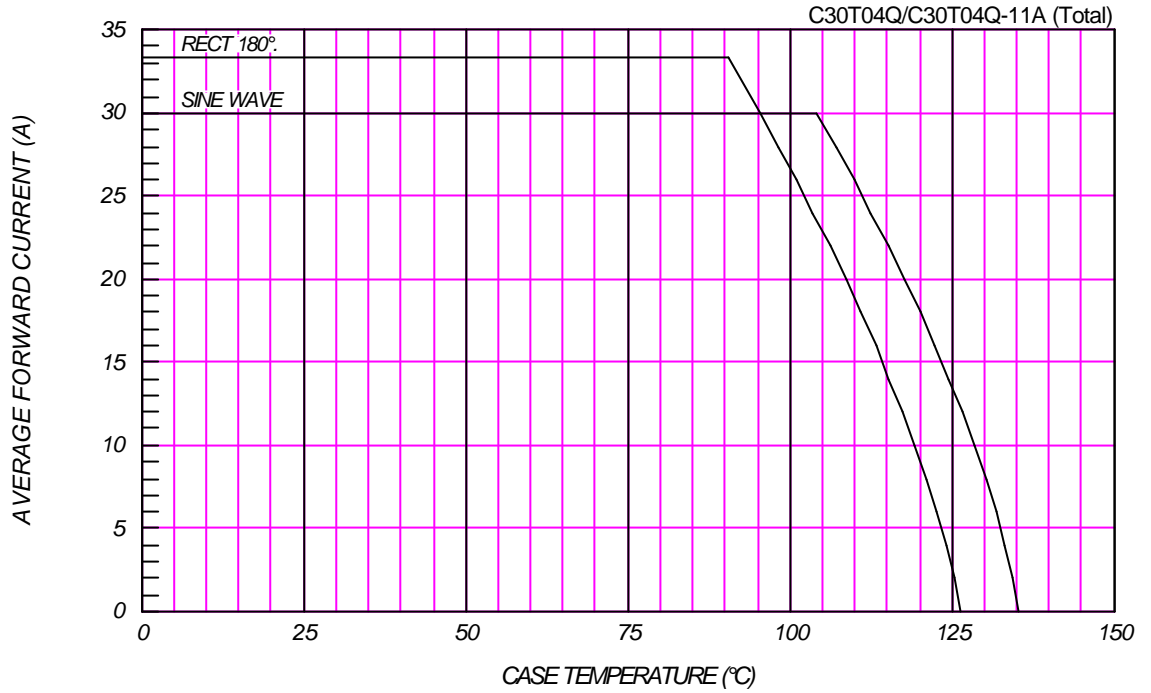

SURGE CURRENT RATINGS

f=50Hz, Sine Wave, Non-Repetitive, No Load

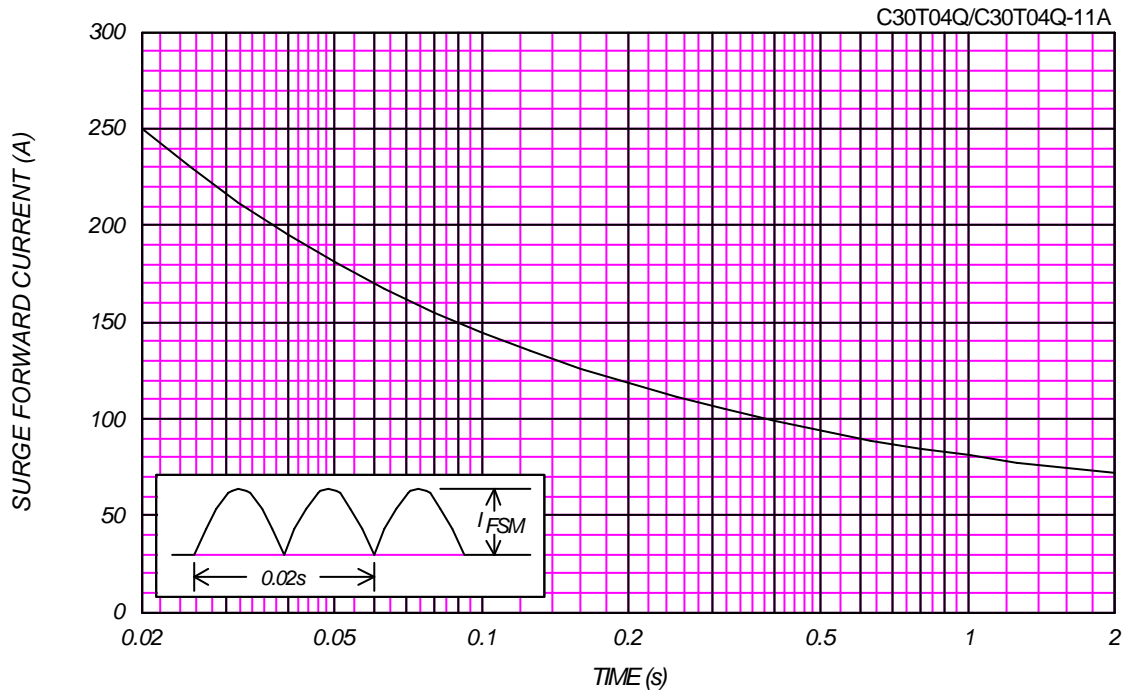

JUNCTION CAPACITANCE VS. REVERSE VOLTAGE

$T_j=25^\circ\text{C}$, $V_m=20\text{mV}_{\text{RMS}}$, $f=100\text{kHz}$, Typical Value

C30T04Q/C30T04Q-11A (per Arm)

