

Feature

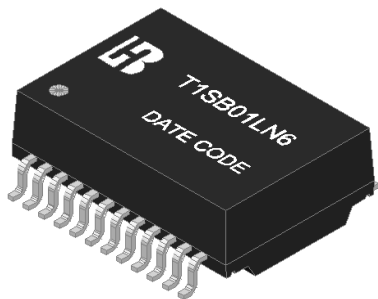

- Complying with IEEE 802.3an standard.
- PASS K21 surge 6KV (common mode&differential mode) .
- Complying with ROHS & Halogen Free requirements.
- Operating temperature range: -40°C to +90°C .
- Storage temperature range: -40°C to +90°C .

Electrical Specifications @ 25°C							
Part Number	Turns Ratio (±5%)		OCL (uH Min) @100KHz/0.1V	L.L (uH Max)	C _{w/w} (pF Max)	DCR (Ω Max)	HI-POT
	TX	RX					
T1SB01LN6	1CT:1CT	1CT:1CT	100	0.5	28	1.0	AC4000V/1mA
Continue							
Part Number	Insertion Loss (dB Max)			Return Loss (dB Min)@ Load 100Ω			
	1-100MHz	100-400MHz	500MHz	1 ≤ f ≤ 40 MHz	40 < f ≤ 400 MHz	400 < f ≤ 500 MHz	
T1SB01LN6	-1.0	-1.5	-2.0	-18	- (18-10 log ₁₀ (f/40))	- (8-30 log ₁₀ (f/400))	
Continue							
Part Number	Cross talk (dB Min)		DCMR (dB Min)				
	1-100 MHz	100-500 MHz	1-250 MHz	250-500 MHz			
T1SB01LN6	-40	-30	-30	-22			

Schematic

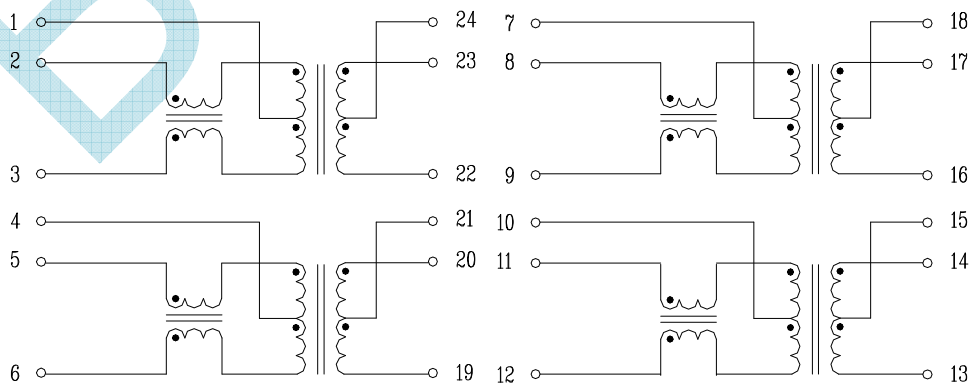

Mechanical

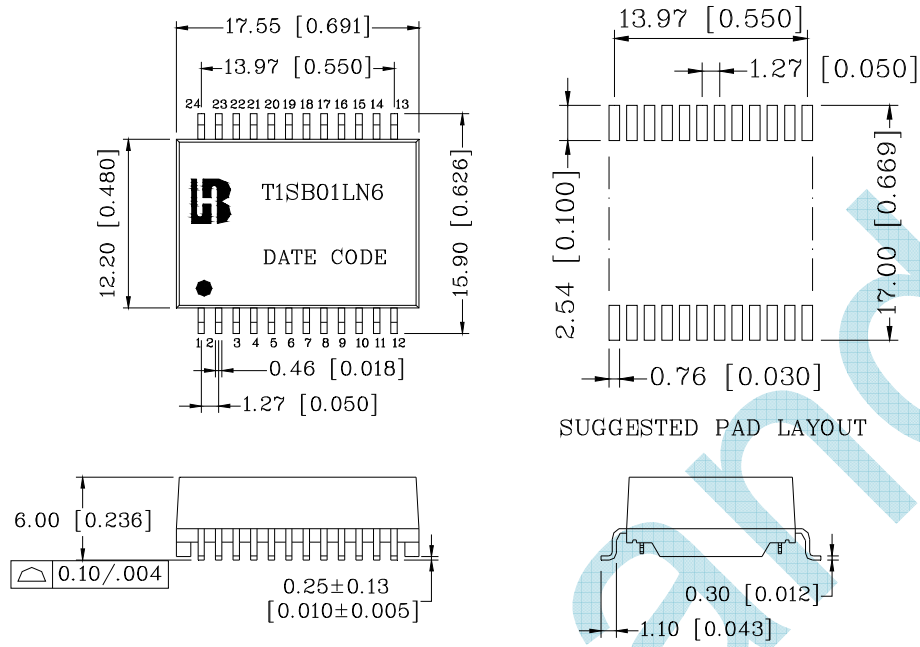

Units: mm[Inches] Tolerances: xx.xx±0.25[0.010]
0.xx±0.05[0.002]

REEL PACKAGE

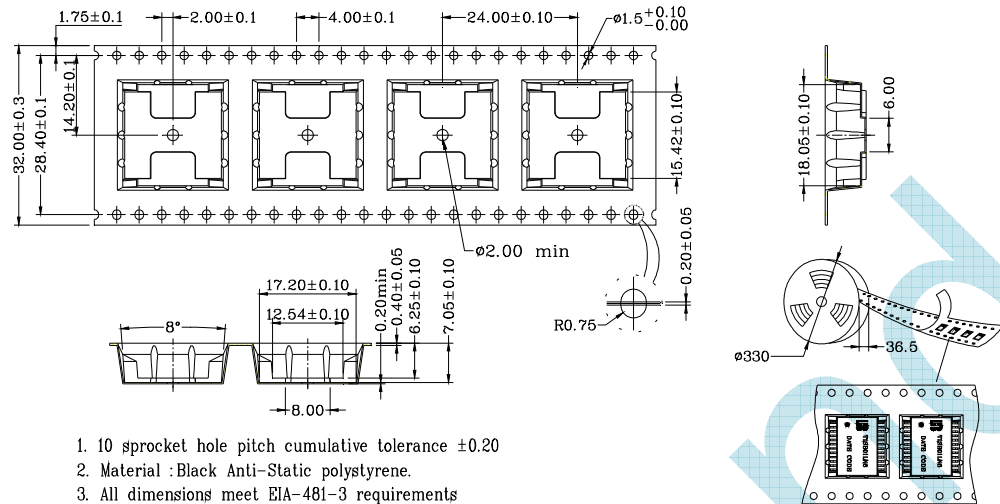

1. 10 sprocket hole pitch cumulative tolerance ±0.20
2. Material : Black Anti-Static polystyrene.
3. All dimensions meet EIA-481-3 requirements
4. Thickness : 0.40±0.05 mm
5. Component load per 13" reel : 350 pcs
6. Carrier camber is within 1 mm in 250 mm
7. Packing length per 22 reel : 29 Meters
8. Comply with Bothhand's <BHKP-WI-44-005> requirements

CARTON PACKAGE

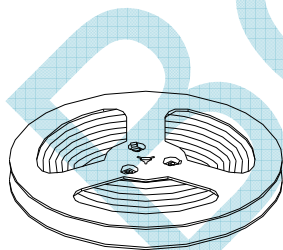

REEL

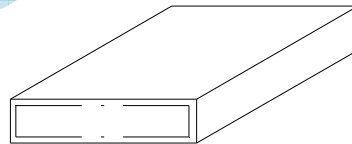

INNER BOX: 347x347x82

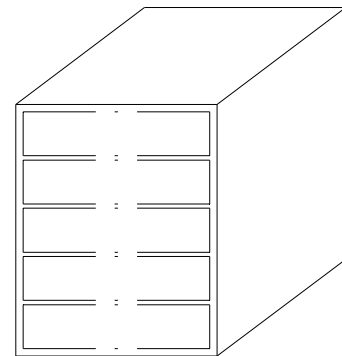

OUTER CARTON: 375x375x470

1. 1 REEL=350PCS
2. 1 INNER BOX=1 REEL=350PCS
3. 1 OUTER CARTON=5 INNER BOXES=1750PCS