

Surface mount transient voltage suppressor power 400 watts

FEATURES

- For surface mounted applications in order to optimize board space.
- Low profile package
- Glass passivated junction
- Low inductance
- Plastic package has Underwriters Laboratory Flammability

SMAF

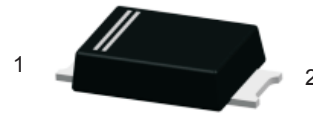

CIRCUIT DIAGRAM

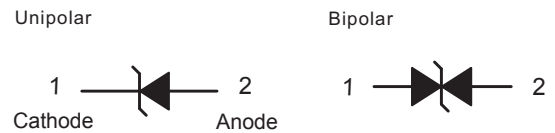

MECHANICAL DATA

- Case: SMAF
- Terminals: Solderable per MIL-STD-750, Method 2026
- Approx. Weight: 27mg 0.00095oz

MAXIMUM RATINGS (Ta=25°C unless otherwise noted)

Parameter	Symbol	Value	Unit
Peak Pulse Power Dissipation on 10/1000us waveform	P_{PPM}	400	W
Peak Forward Surge Current (Note 2, Fig 4)	I_{FSM}	60	A
Peak Pulse Current on 10/1000 us waveform (Note 1, Fig 2)	I_{PPM}	see Table 1	A
Typical Junction capacitance at VR=4V, f=1MHz	C_J	390	pF
ESD Voltage per IEC6100-4-2	V_{ESD1} V_{ESD2}	± 8 ± 15	kV
Typical Thermal Resistance Junction to Ambient(Note 2)	R_{θ}	120	°C/W
Operating Junction Temperature and Storage Temperature Range	T_J, T_{stg}	-55 ~ +175	°C

NOTES:

1. Non-repetitive current pulse, per Fig.3 and derated above $T_A = 25^\circ\text{C}$ per Fig. 2.
2. Mounted on FR-4 PCB single-sided copper, mini pad.
3. Peak Forward Surge Current : 8.3ms single half sine-wave Superimposed on rated load (JEDEC method).
4. Peak pulse power waveform is 10/1000µS.

ELECTRICAL CHARACTERISTICS Ta=25 °C unless otherwise specified

Type		Reverse Stand-off Voltage	Breakdown Voltage		Test Current	Reverse Leakage	Max. Clamp Voltage	Peak Pulse Current	Package	
			V _{BR} @ I _T						SMAF	
			V _{RRM}	Min	Max	I _T	I _R @ V _{RRM}	V _C @ I _{PP}	I _{PP}	Device Marking Ccode
UNI	BI	V	V	V	mA	µA	V	A	UNI	BI
SMAFJ5.0A	SMAFJ5.0CA	5	6.4	7	10	800	9.2	43.5	AE	WE
SMAFJ6.0A	SMAFJ6.0CA	6	6.67	7.37	10	800	10.3	38.8	AG	WG
SMAFJ6.5A	SMAFJ6.5CA	6.5	7.22	7.98	10	500	11.2	35.7	AK	WK
SMAFJ7.0A	SMAFJ7.0CA	7	7.78	8.6	10	200	12.0	33.3	AM	WM
SMAFJ7.5A	SMAFJ7.5CA	7.5	8.33	9.21	1	100	12.9	31.0	AP	WP
SMAFJ8.0A	SMAFJ8.0CA	8	8.89	9.83	1	50	13.6	29.4	AR	WR
SMAFJ8.5A	SMAFJ8.5CA	8.5	9.44	10.4	1	20	14.4	27.8	AT	WT
SMAFJ9.0A	SMAFJ9.0CA	9	10	11.1	1	10	15.4	26.0	AV	WV
SMAFJ10A	SMAFJ10CA	10	11.1	12.3	1	5	17.0	23.5	AX	WX
SMAFJ11A	SMAFJ11CA	11	12.2	13.5	1	1	18.2	22.0	AZ	WZ
SMAFJ12A	SMAFJ12CA	12	13.3	14.7	1	1	19.9	20.1	BE	XE
SMAFJ13A	SMAFJ13CA	13	14.4	15.9	1	1	21.5	18.6	BG	XG
SMAFJ14A	SMAFJ14CA	14	15.6	17.2	1	1	23.2	17.2	BK	XK
SMAFJ15A	SMAFJ15CA	15	16.7	18.5	1	1	24.4	16.4	BM	XM
SMAFJ16A	SMAFJ16CA	16	17.8	19.7	1	1	26.0	15.4	BP	XP
SMAFJ17A	SMAFJ17CA	17	18.9	20.9	1	1	27.6	14.5	BR	XR
SMAFJ18A	SMAFJ18CA	18	20	22.1	1	1	29.2	13.7	BT	XT
SMAFJ20A	SMAFJ20CA	20	22.2	24.5	1	1	32.4	12.3	BV	XV
SMAFJ22A	SMAFJ22CA	22	24.4	26.9	1	1	35.5	11.3	BX	XX
SMAFJ24A	SMAFJ24CA	24	26.7	29.5	1	1	38.9	10.3	BZ	XZ
SMAFJ26A	SMAFJ26CA	26	28.9	31.9	1	1	42.1	9.5	CE	YE
SMAFJ28A	SMAFJ28CA	28	31.1	34.4	1	1	45.4	8.8	CG	YG
SMAFJ30A	SMAFJ30CA	30	33.3	36.8	1	1	48.4	8.3	CK	YK
SMAFJ33A	SMAFJ33CA	33	36.7	40.6	1	1	53.3	7.5	CM	YM
SMAFJ36A	SMAFJ36CA	36	40	44.2	1	1	58.1	6.9	CP	YP
SMAFJ40A	SMAFJ40CA	40	44.4	49.1	1	1	64.5	6.2	CR	YR
SMAFJ43A	SMAFJ43CA	43	47.8	52.8	1	1	69.4	5.8	CT	YT
SMAFJ45A	SMAFJ45CA	45	50	55.3	1	1	72.7	5.5	CV	YV
SMAFJ48A	SMAFJ48CA	48	53.3	58.9	1	1	77.4	5.2	CX	YX
SMAFJ51A	SMAFJ51CA	51	56.7	62.7	1	1	82.4	4.9	CZ	YZ
SMAFJ54A	SMAFJ54CA	54	60	66.3	1	1	87.1	4.6	RE	ZE
SMAFJ58A	SMAFJ58CA	58	64.4	71.2	1	1	93.6	4.3	RG	ZG
SMAFJ60A	SMAFJ60CA	60	66.7	73.7	1	1	96.8	4.1	RK	ZK
SMAFJ64A	SMAFJ64CA	64	71.1	78.6	1	1	103.0	3.9	RM	ZM
SMAFJ70A	SMAFJ70CA	70	77.8	86	1	1	113.0	3.5	RP	ZP
SMAFJ75A	SMAFJ75CA	75	83.3	92.1	1	1	121.0	3.3	RR	ZR
SMAFJ78A	SMAFJ78CA	78	86.7	95.8	1	1	126.0	3.2	RT	ZT
SMAFJ85A	SMAFJ85CA	85	94.4	104	1	1	137.0	2.9	RV	ZV
SMAFJ90A	SMAFJ90CA	90	100	111	1	1	146.0	2.7	RX	ZX
SMAFJ100A	SMAFJ100CA	100	111	123	1	1	162.0	2.5	RZ	ZZ
SMAFJ110A	SMAFJ110CA	110	122	135	1	1	177.0	2.3	SE	VE
SMAFJ120A	SMAFJ120CA	120	133	147	1	1	193.0	2.1	SG	VG
SMAFJ130A	SMAFJ130CA	130	144	159	1	1	209.0	1.9	SK	VK
SMAFJ150A	SMAFJ150CA	150	167	185	1	1	243.0	1.6	SM	VM
SMAFJ160A	SMAFJ160CA	160	178	197	1	1	259.0	1.5	SP	VP
SMAFJ170A	SMAFJ170CA	170	189	209	1	1	275.0	1.5	SR	VR
SMAFJ180A	SMAFJ180CA	180	201	222	1	1	292.0	1.4	ST	VT
SMAFJ200A	SMAFJ200CA	200	224	247	1	1	324.0	1.2	SV	VV
SMAFJ220A	SMAFJ220CA	220	246	272	1	1	356.0	1.1	SX	VX
SMAFJ250A	SMAFJ250CA	250	279	309	1	1	405.0	1.0	SZ	VZ
SMAFJ300A	SMAFJ300CA	300	335	371	1	1	486.0	0.8	TE	UE

ELECTRICAL CHARACTERISTICS Ta=25 °C unless otherwise specified (cont.)

Type		Reverse Stand-off Voltage	Breakdown Voltage		Test Current	Reverse Leakage	Max. Clamp Voltage	Peak Pulse Current	Package	
			V _{BR} @ I _T						SMAF	
		V _{RRM}	Min	Max	I _T	I _R @ V _{RRM}	V _C @ I _{PP}	I _{PP}	Device Marking Ccode	
UNI	BI	V	V	V	mA	µA	V	A	UNI	BI
SMAFJ350A	SMAFJ350CA	350	391	432	1	1	567.0	0.7	TG	UG
SMAFJ400A	SMAFJ400CA	400	447	494	1	1	648.0	0.6	TK	UK
SMAFJ440A	SMAFJ440CA	440	492	543	1	1	713.0	0.6	TM	UM

TYPICAL CHARACTERISTICS

Fig.1 Peak Pulse Power Rating Curve

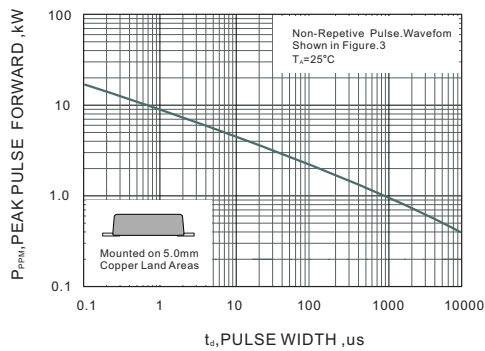

Fig.2 Forward Current Derating Curve

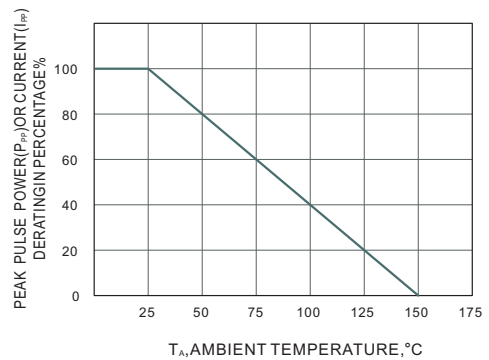

Fig.3 Pulse Waveform

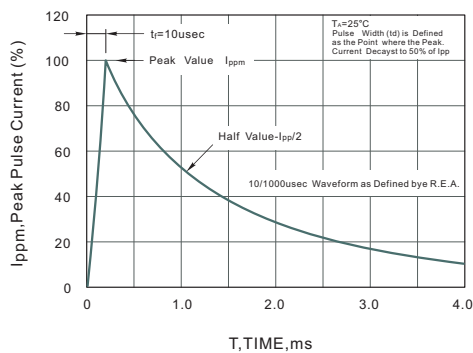
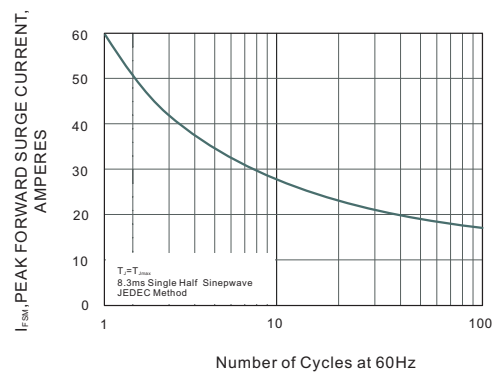
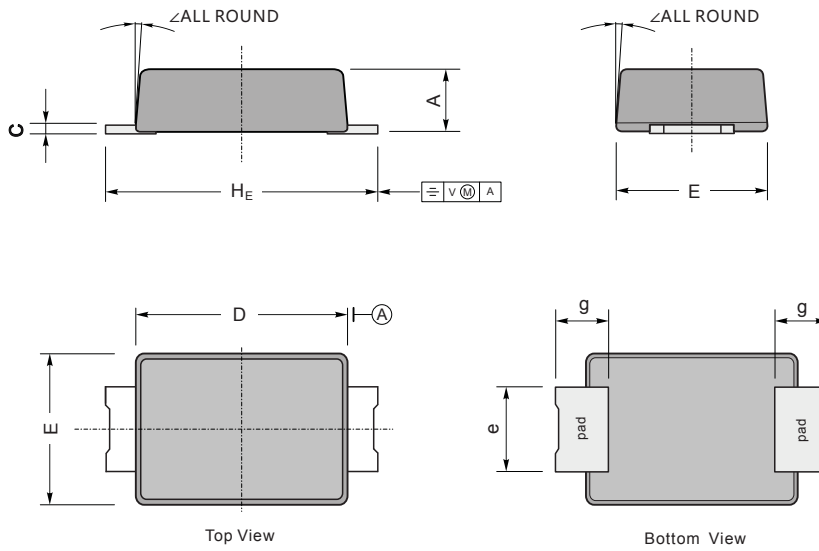

Fig.4 Maximum Non-Repetitive Peak Forward Surge Current



SMAF PACKAGE OUTLINE DRAWING



SYM	MILLIMETERS		INCHES	
	MIN	MAX	MIN	MAX
A	0.90	1.20	0.035	0.047
C	0.12	0.20	0.005	0.008
D	3.30	3.70	0.130	0.146
E	2.40	2.70	0.094	0.106
e	1.30	1.60	0.051	0.063
g	0.80	1.20	0.031	0.047
H_E	4.40	4.90	0.173	0.193
\angle	7°		7°	