

**Triacs
logic level**

BT134 series D

GENERAL DESCRIPTION

Glass passivated, sensitive gate triacs in a plastic envelope, intended for use in general purpose bidirectional switching and phase control applications. These devices are intended to be interfaced directly to microcontrollers, logic integrated circuits and other low power gate trigger circuits.

QUICK REFERENCE DATA

| SYMBOL | PARAMETER | MAX. | MAX. | UNIT |
|--------------|--------------------------------------|--------------------|--------------------|------|
| V_{DRM} | Repetitive peak off-state voltages | 500D 500 | 600D 600 | V |
| $I_{T(RMS)}$ | RMS on-state current | 4 | 4 | A |
| I_{TSM} | Non-repetitive peak on-state current | 25 | 25 | A |

PINNING - SOT82

| PIN | DESCRIPTION |
|-----|-----------------|
| 1 | main terminal 1 |
| 2 | main terminal 2 |
| 3 | gate |
| tab | main terminal 2 |

PIN CONFIGURATION

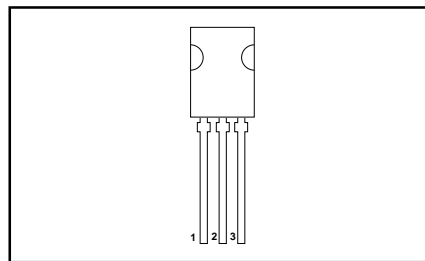

SYMBOL

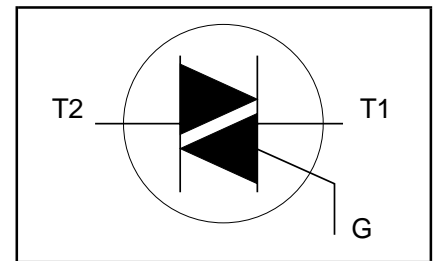

LIMITING VALUES

Limiting values in accordance with the Absolute Maximum System (IEC 134).

| SYMBOL | PARAMETER | CONDITIONS | MIN. | MAX. | | UNIT |
|--------------|--|--|------|--------------------------|--------------------------|------------------|
| | | | | -500 500 ¹ | -600 600 ¹ | |
| V_{DRM} | Repetitive peak off-state voltages | | - | -500 500 ¹ | -600 600 ¹ | V |
| $I_{T(RMS)}$ | RMS on-state current | full sine wave; $T_{mb} \leq 107^\circ\text{C}$ | - | 4 | | A |
| I_{TSM} | Non-repetitive peak on-state current | full sine wave; $T_j = 25^\circ\text{C}$ prior to surge $t = 20\text{ ms}$ | - | 25 | | A |
| | | $t = 16.7\text{ ms}$ | - | 27 | | A |
| | | $t = 10\text{ ms}$ | - | 3.1 | | A ² s |
| I^2t | I^2t for fusing | | - | | | |
| di_T/dt | Repetitive rate of rise of on-state current after triggering | $I_{TM} = 6\text{ A}$; $I_G = 0.2\text{ A}$; $di_G/dt = 0.2\text{ A}/\mu\text{s}$ | | | | |
| | | T2+ G+ | - | 50 | | A/ μs |
| | | T2+ G- | - | 50 | | A/ μs |
| | | T2- G- | - | 50 | | A/ μs |
| | | T2- G+ | - | 10 | | A/ μs |
| I_{GM} | Peak gate current | | - | 2 | | A |
| V_{GM} | Peak gate voltage | | - | 5 | | V |
| P_{GM} | Peak gate power | | - | 5 | | W |
| $P_{G(AV)}$ | Average gate power | over any 20 ms period | - | 0.5 | | W |
| T_{stg} | Storage temperature | | -40 | 150 | | $^\circ\text{C}$ |
| T_j | Operating junction temperature | | - | 125 | | $^\circ\text{C}$ |

¹ Although not recommended, off-state voltages up to 800V may be applied without damage, but the triac may switch to the on-state. The rate of rise of current should not exceed 3 A/ μs .

Triacs

logic level

BT134 series D

THERMAL RESISTANCES

| SYMBOL | PARAMETER | CONDITIONS | MIN. | TYP. | MAX. | UNIT |
|----------------|---|-------------|------|------|------|------|
| $R_{th\ j-mb}$ | Thermal resistance junction to mounting base | full cycle | - | - | 3.0 | K/W |
| | | half cycle | - | - | 3.7 | K/W |
| $R_{th\ j-a}$ | Thermal resistance junction to ambient | in free air | - | 100 | - | K/W |

STATIC CHARACTERISTICS

$T_j = 25\text{ }^\circ\text{C}$ unless otherwise stated

| SYMBOL | PARAMETER | CONDITIONS | MIN. | TYP. | MAX. | UNIT |
|----------|---------------------------|---|------|------|------|------|
| I_{GT} | Gate trigger current | $V_D = 12\text{ V}; I_T = 0.1\text{ A}$ | | | | |
| | | T2+ G+ | - | 2.0 | 5 | mA |
| | | T2+ G- | - | 2.5 | 5 | mA |
| | | T2- G- | - | 2.5 | 5 | mA |
| | | T2- G+ | - | 5.0 | 10 | mA |
| I_L | Latching current | $V_D = 12\text{ V}; I_{GT} = 0.1\text{ A}$ | | | | |
| | | T2+ G+ | - | 1.6 | 10 | mA |
| | | T2+ G- | - | 4.5 | 15 | mA |
| | | T2- G- | - | 1.2 | 10 | mA |
| | | T2- G+ | - | 2.2 | 15 | mA |
| I_H | Holding current | $V_D = 12\text{ V}; I_{GT} = 0.1\text{ A}$ | - | 1.2 | 10 | mA |
| V_T | On-state voltage | $I_T = 5\text{ A}$ | - | 1.4 | 1.70 | V |
| V_{GT} | Gate trigger voltage | $V_D = 12\text{ V}; I_T = 0.1\text{ A}$ | - | 0.7 | 1.5 | V |
| | | $V_D = 400\text{ V}; I_T = 0.1\text{ A}; T_j = 125\text{ }^\circ\text{C}$ | 0.25 | 0.4 | - | V |
| I_D | Off-state leakage current | $V_D = V_{DRM(max)}; T_j = 125\text{ }^\circ\text{C}$ | - | 0.1 | 0.5 | mA |

DYNAMIC CHARACTERISTICS

$T_j = 25\text{ }^\circ\text{C}$ unless otherwise stated

| SYMBOL | PARAMETER | CONDITIONS | MIN. | TYP. | MAX. | UNIT |
|-----------|---|---|------|------|------|------------------|
| dV_D/dt | Critical rate of rise of off-state voltage | $V_{DM} = 67\% V_{DRM(max)}; T_j = 125\text{ }^\circ\text{C};$ exponential waveform; $R_{GK} = 1\text{ k}\Omega$ | - | 5 | - | V/ μs |
| t_{gt} | Gate controlled turn-on time | $I_{TM} = 6\text{ A}; V_D = V_{DRM(max)}; I_G = 0.1\text{ A};$ $di_G/dt = 5\text{ A}/\mu\text{s}$ | - | 2 | - | μs |

Triacs
logic level

BT134 series D



Fig.1. Maximum on-state dissipation, P_{tot} , versus rms on-state current, $I_{T(RMS)}$, where $\alpha =$ conduction angle.

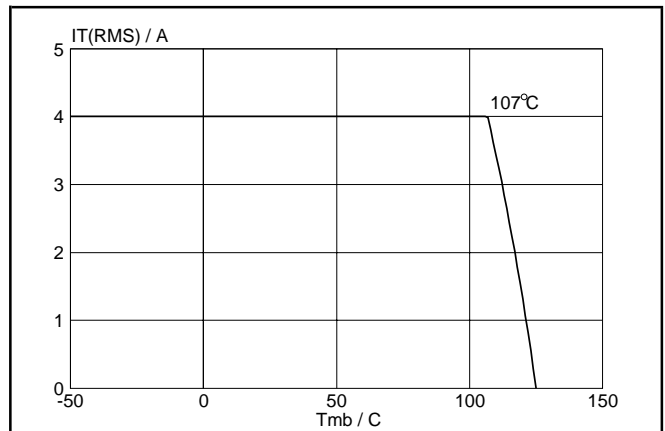

Fig.4. Maximum permissible rms current $I_{T(RMS)}$, versus mounting base temperature T_{mb} .



Fig.2. Maximum permissible non-repetitive peak on-state current I_{TSM} , versus pulse width t_p , for sinusoidal currents, $t_p \leq 20\text{ms}$.



Fig.5. Maximum permissible repetitive rms on-state current $I_{T(RMS)}$, versus surge duration, for sinusoidal currents, $f = 50\text{ Hz}$; $T_{mb} \leq 107^\circ\text{C}$.

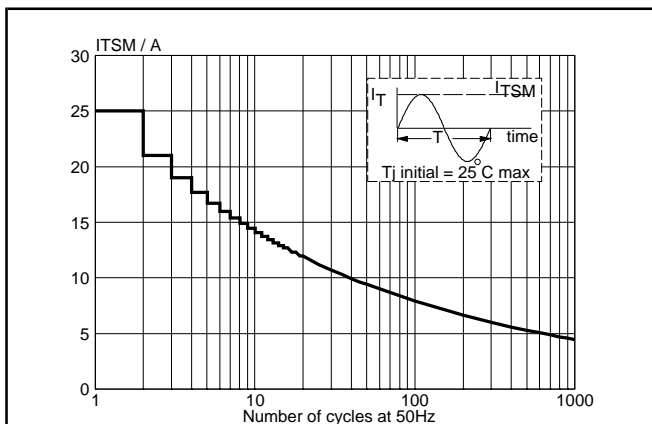

Fig.3. Maximum permissible non-repetitive peak on-state current I_{TSM} , versus number of cycles, for sinusoidal currents, $f = 50\text{ Hz}$.

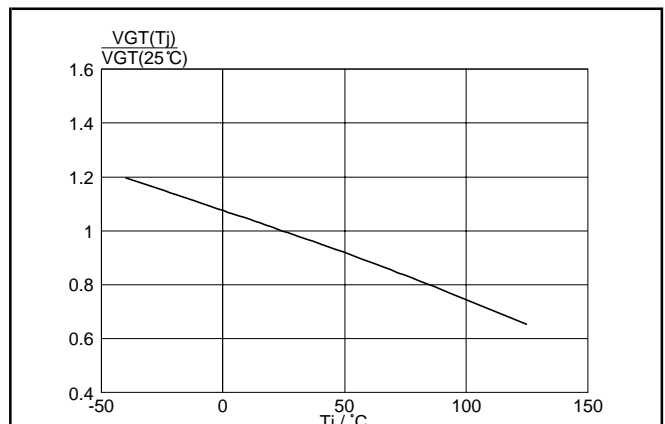
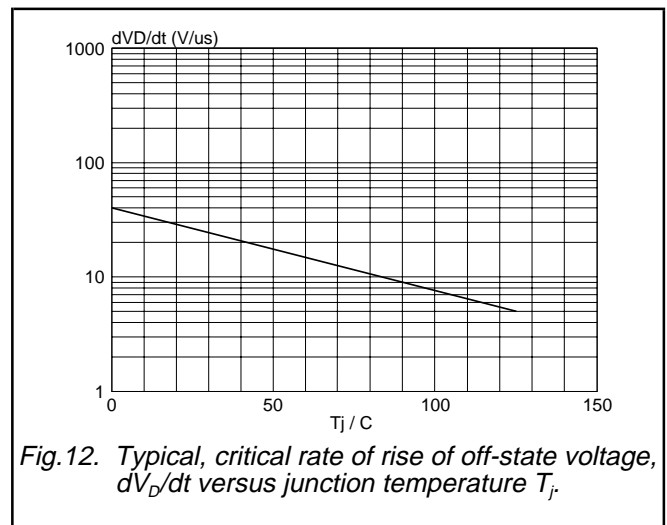
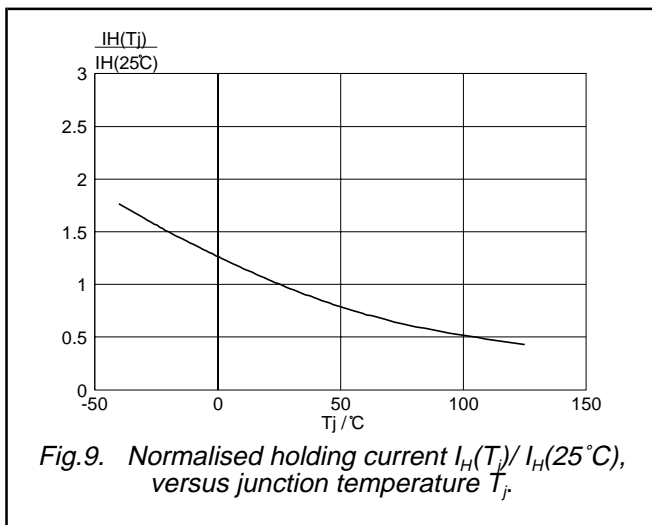
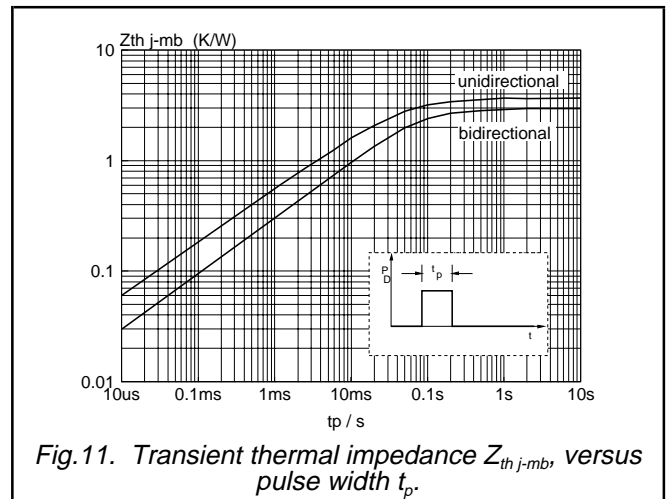
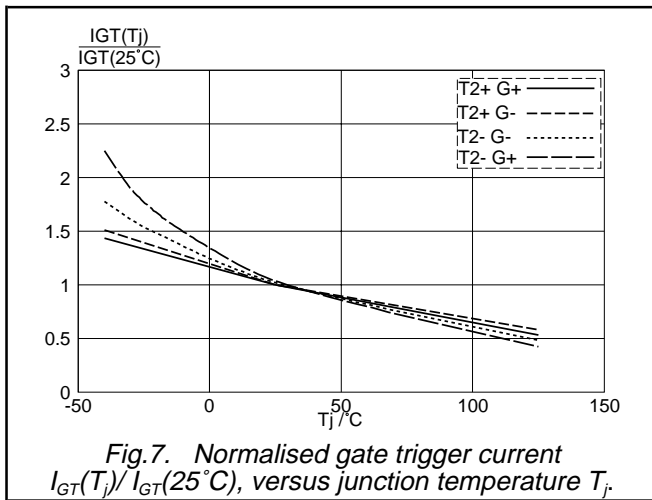

Fig.6. Normalised gate trigger voltage $V_{GT}(T_j) / V_{GT}(25^\circ\text{C})$, versus junction temperature T_j .

Triacs
logic level

BT134 series D



Triacs
logic level

BT134 series D

MECHANICAL DATA

Dimensions in mm

Net Mass: 0.8 g

mounting
base

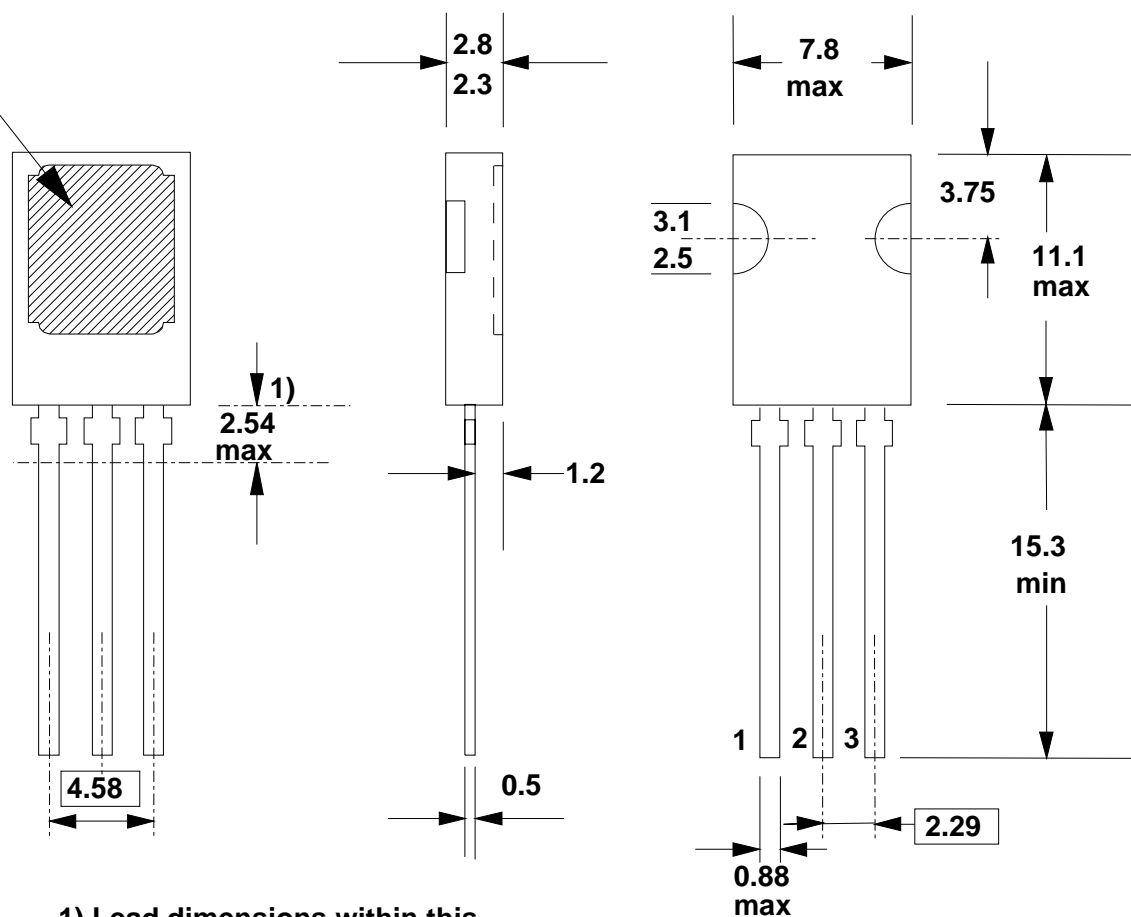

1) Lead dimensions within this zone uncontrolled.

Fig.13. SOT82; pin 2 connected to mounting base.

Notes

1. Refer to mounting instructions for SOT82 envelopes.
2. Epoxy meets UL94 V0 at 1/8".

Triacs logic level

BT134 series D

DEFINITIONS

| | |
|--|---|
| Data sheet status | |
| Objective specification | This data sheet contains target or goal specifications for product development. |
| Preliminary specification | This data sheet contains preliminary data; supplementary data may be published later. |
| Product specification | This data sheet contains final product specifications. |
| Limiting values | |
| Limiting values are given in accordance with the Absolute Maximum Rating System (IEC 134). Stress above one or more of the limiting values may cause permanent damage to the device. These are stress ratings only and operation of the device at these or at any other conditions above those given in the Characteristics sections of this specification is not implied. Exposure to limiting values for extended periods may affect device reliability. | |
| Application information | |
| Where application information is given, it is advisory and does not form part of the specification. | |
| © Philips Electronics N.V. 1997 | |
| All rights are reserved. Reproduction in whole or in part is prohibited without the prior written consent of the copyright owner. | |
| The information presented in this document does not form part of any quotation or contract, it is believed to be accurate and reliable and may be changed without notice. No liability will be accepted by the publisher for any consequence of its use. Publication thereof does not convey nor imply any license under patent or other industrial or intellectual property rights. | |

LIFE SUPPORT APPLICATIONS

These products are not designed for use in life support appliances, devices or systems where malfunction of these products can be reasonably expected to result in personal injury. Philips customers using or selling these products for use in such applications do so at their own risk and agree to fully indemnify Philips for any damages resulting from such improper use or sale.