

- 310.0 to 319.5 MHz Filter
- Optimized for use with the TRC105 Transceiver
- Balanced 150 ohm IC Interface
- Complies with Directive 2002/95/EC (RoHS)

RoHS
Compliant

RF3603D

316.4 MHz
SAW Filter

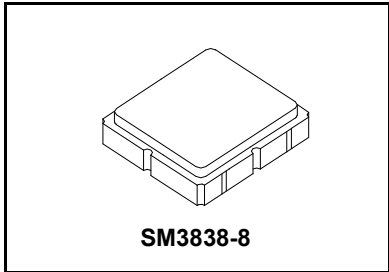

Absolute Maximum Ratings

Rating	Value	Units
Input Power Level	+15	dBm
DC Voltage	±5	V
Operating Temperature Range	-40 to +85	°C
Storage Temperature Range in Tape and Reel	-40 to +85	°C
Maximum Soldering Profile, 5 cycles/ 10 seconds maximum	265	°C

Electrical Characteristics

Characteristic	Sym	Notes	Min	Typ	Max	Units
Center Frequency	f_C			316.4		MHz
1 dB Bandwidth	BW_1			13		MHz
Maximum Insertion Loss, 310.0 to 319.5 MHz	IL_{MAX}			1.8	2.2	dB
Amplitude Ripple, p-p, 310.0 to 319.5 MHz					1.0	
Rejection Referenced to Insertion Loss at 315.0 MHz:						
DC to 300 MHz			37	39		
336 to 366 MHz			18	22		
366 to 966 MHz			43	47		
966 to 1266 MHz			43	48		
1266 to 2000 MHz			28	32		
Source Impedance	Z_S			50		Ω
Balanced Load Impedance	Z_L			150		Ω

Case Style	SM3838-8 3.8 x 3.8 mm Nominal Footprint		
Lid Symbolization (Y=year, WW=week, S=shift) dot=pin 1 indicator	886, <u>YWWS</u>		
Standard Reel Quantity	Reel Size 7 Inch	500 Pieces/Reel	
	Reel Size 13 Inch	3000 Pieces/Reel	

Electrical Connections

Connection	Terminals
Single-ended Port	6
Balanced Port	1, 3
Case Ground	4, 5, 7, 8
No Connection	2

CAUTION: Electrostatic Sensitive Device. Observe precautions for handling.
NOTES:

1. The design, manufacturing process, and specifications of this device are subject to change.
2. US or International patents may apply.
3. RoHS compliant from the first date of manufacture.

RF3603D-TRC105 Application Circuit

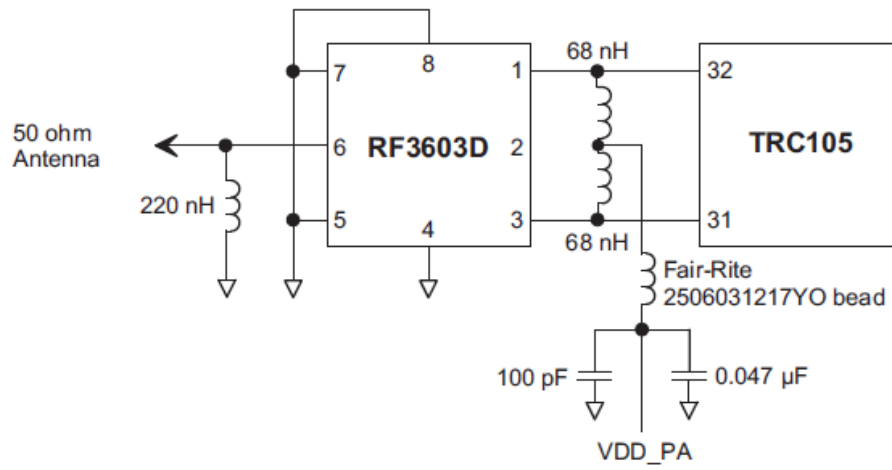

Reference Circuit Diagram Only
Note: TRC105 has been obsoleted

RF3603D 50 Ohm Tuning Network

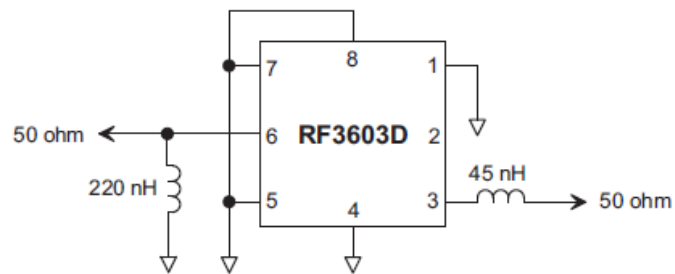

RF3603D Broadband Response, 200 to 2000 MHz

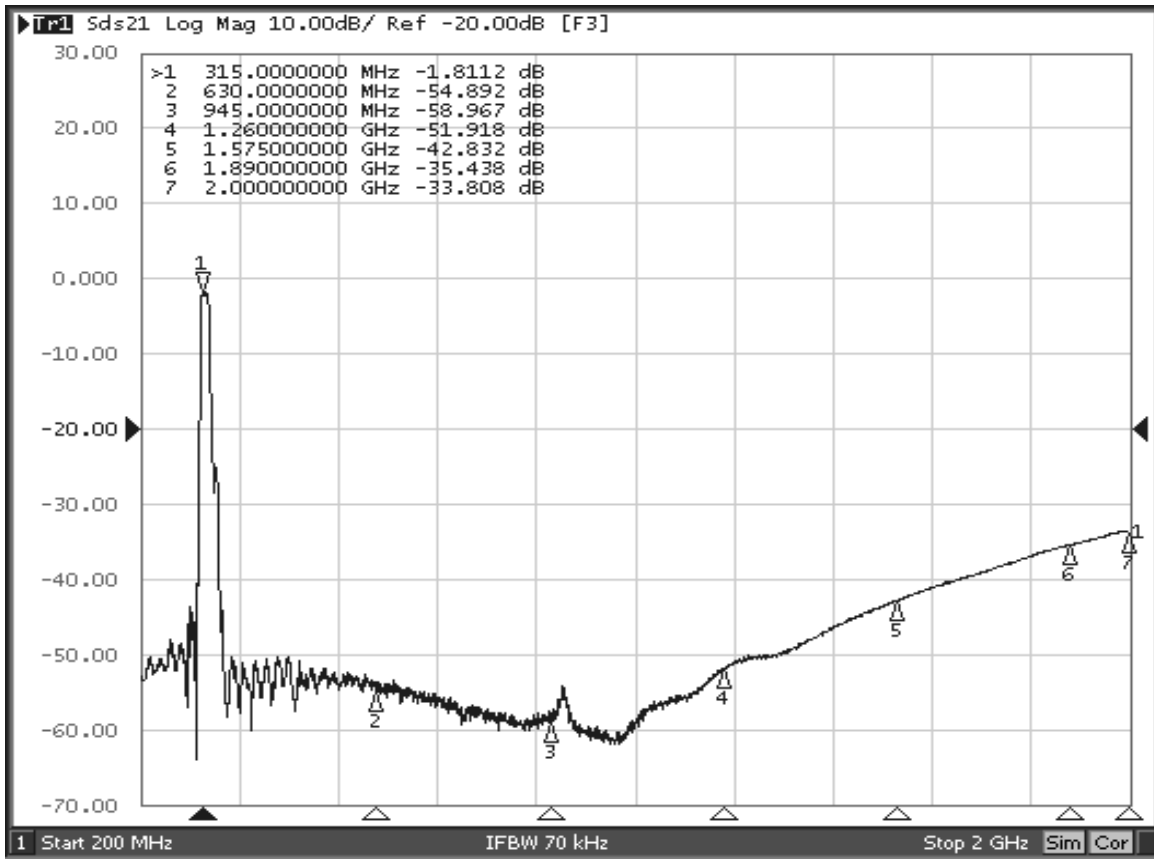

RF3603D Response, 216.4 to 416.4 MHz

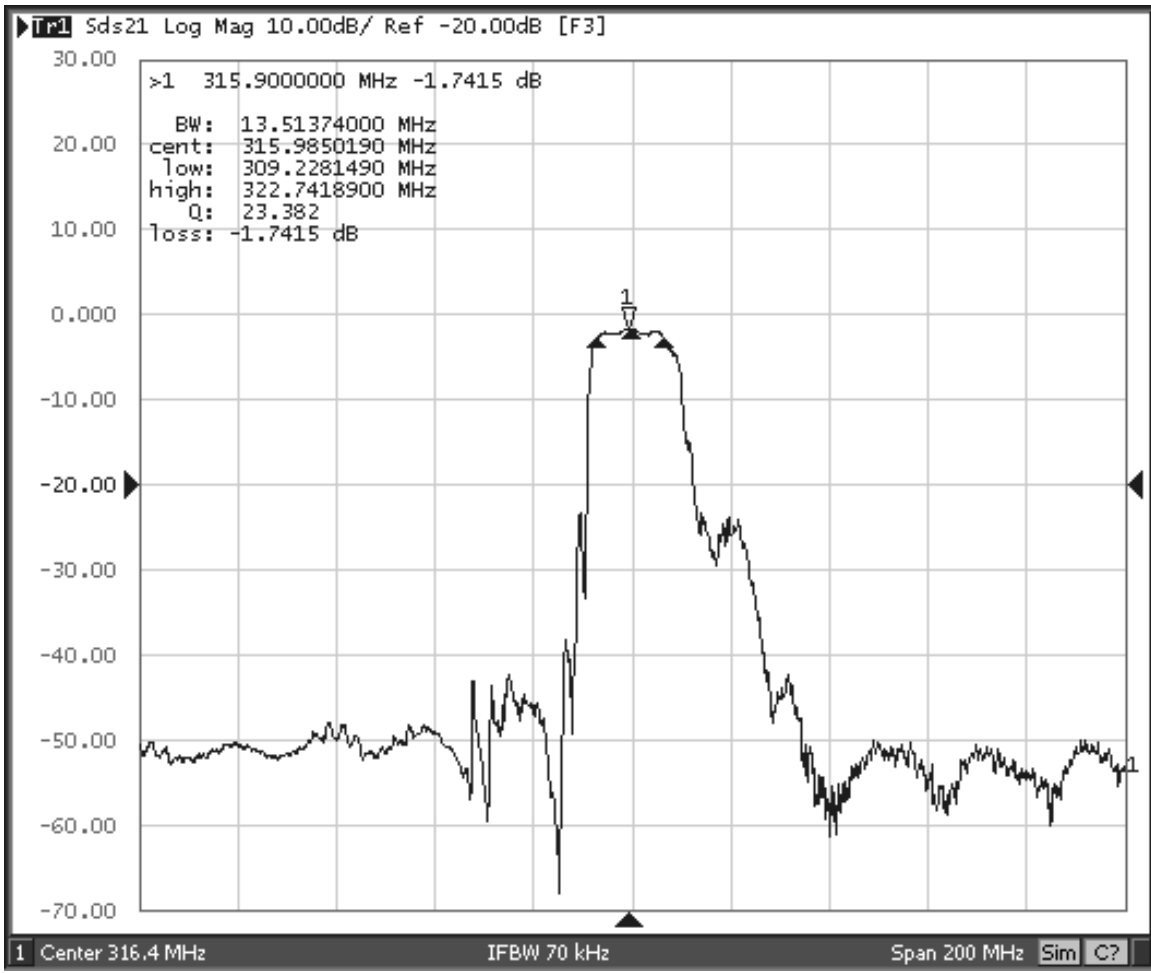

RF3603D Response, 266.4 to 366.4 MHz

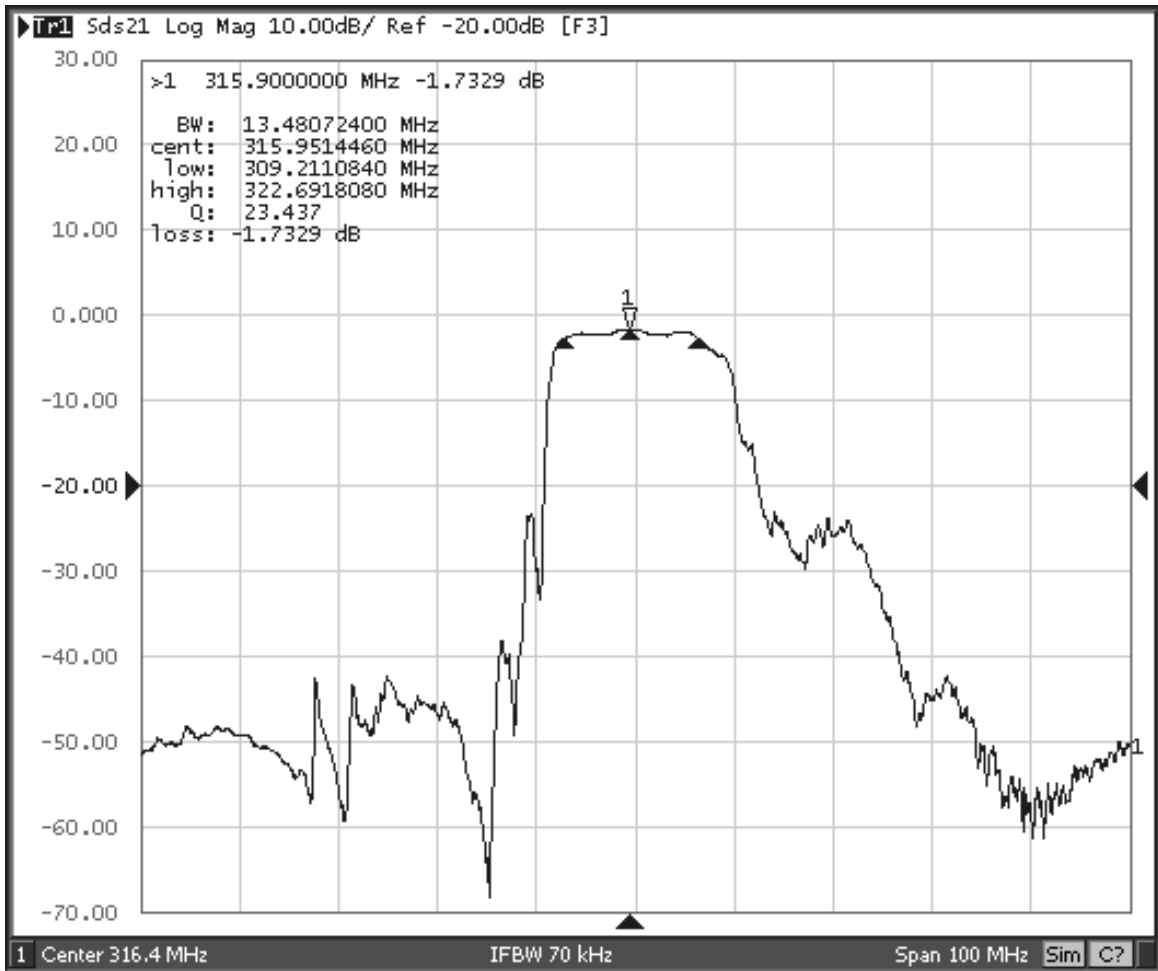

RF3603D Passband Response

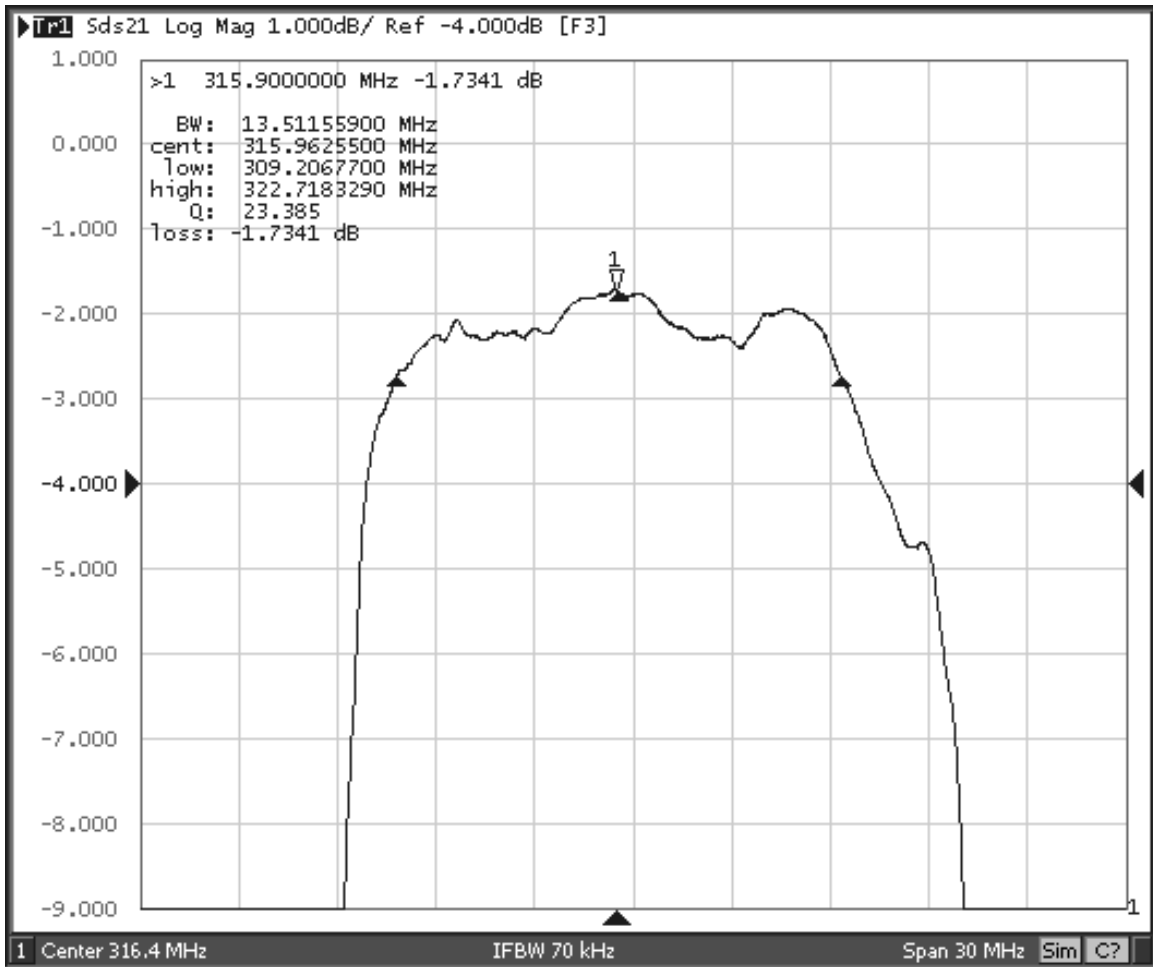

RF3603D Input Impedance Plot

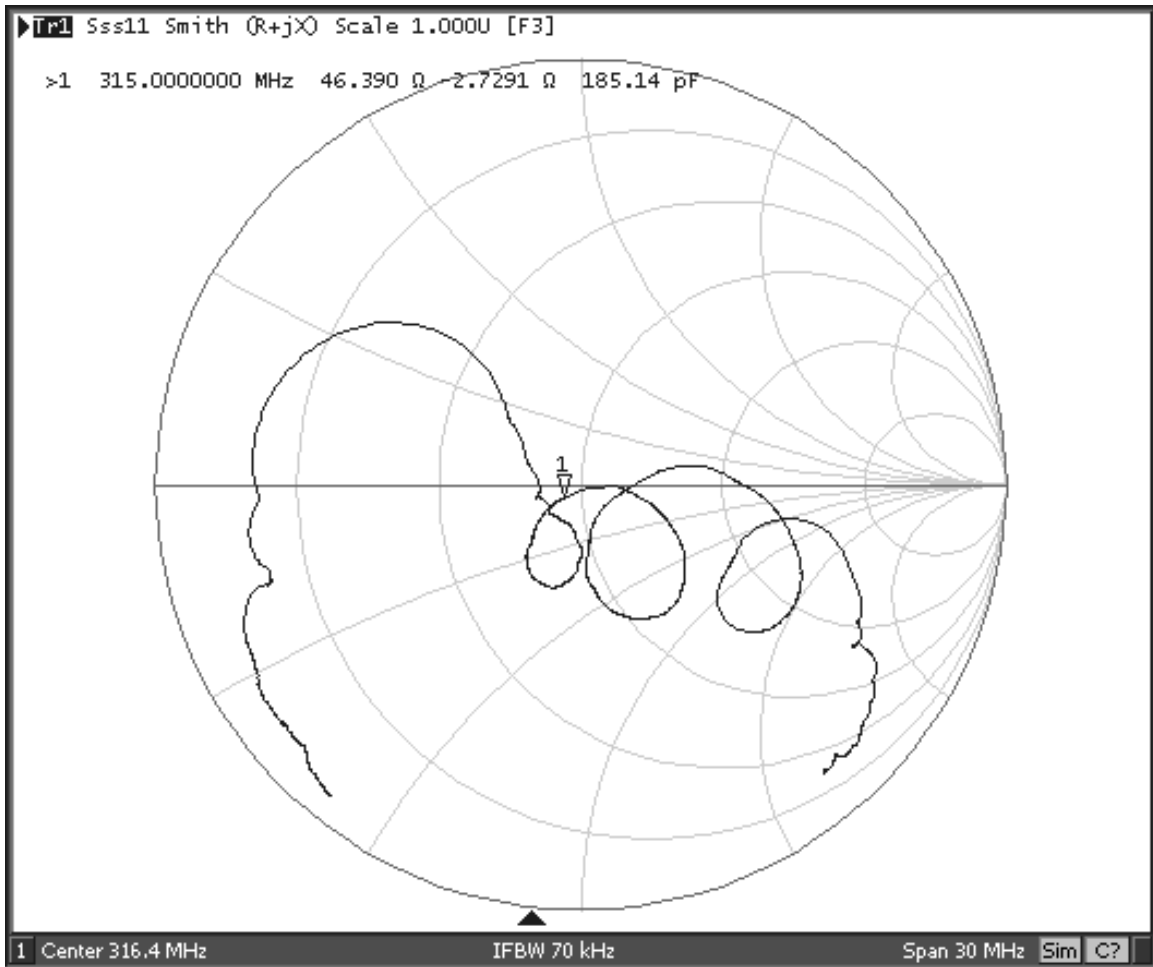

RF3603D Balanced Output Impedance Plot

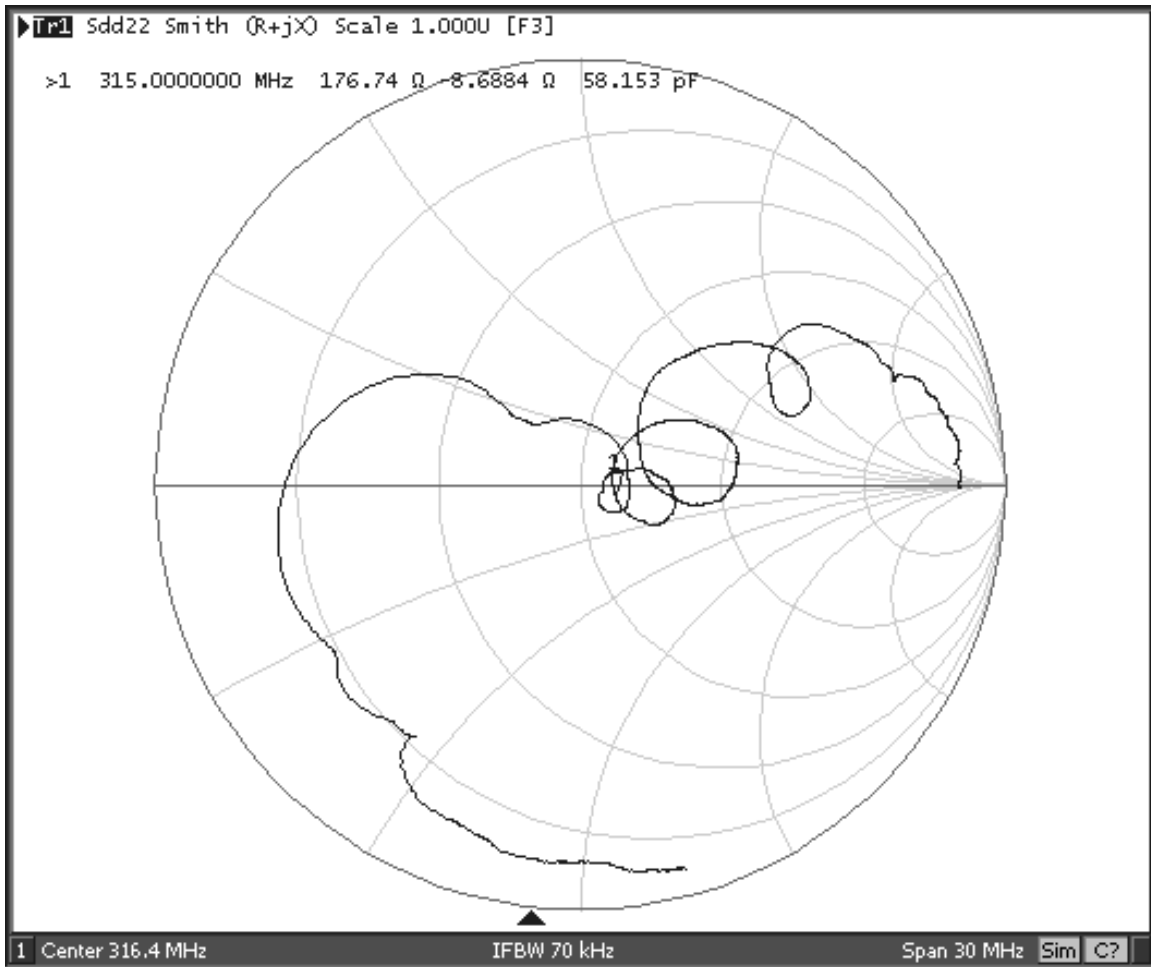

8-Terminal Ceramic Surface-Mount Case 3.8 X 3.8 mm Nominal Footprint

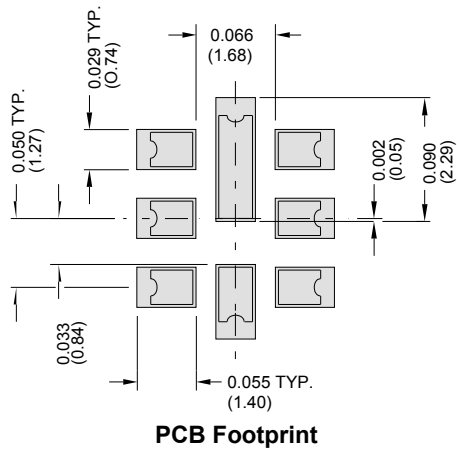

Case Dimensions						
Dimension	mm			Inches		
	Min	Nom	Max	Min	Nom	Max
A	3.6	3.8	4.0	0.142	0.150	0.157
B	3.6	3.8	4.0	0.142	0.150	0.157
C	0.90	1.00	1.1	0.035	0.040	0.043
D	0.80	0.90	1.0	0.031	0.035	0.040
E	0.90	1.00	1.10	0.035	0.040	0.043
F	0.50	0.60	0.70	0.020	0.024	0.028
G	2.39	2.54	2.69	0.090	0.100	0.110
H	1.40	1.75	2.05	0.055	0.069	0.080

Materials	
Solder Pad Plating	0.3 to 1.0 μm Gold over 1.27 to 8.89 μm Nickel
Lid Plating	2.0 to 3.0 μm Nickel
Body	Al_2O_3 Ceramic
Pb Free	

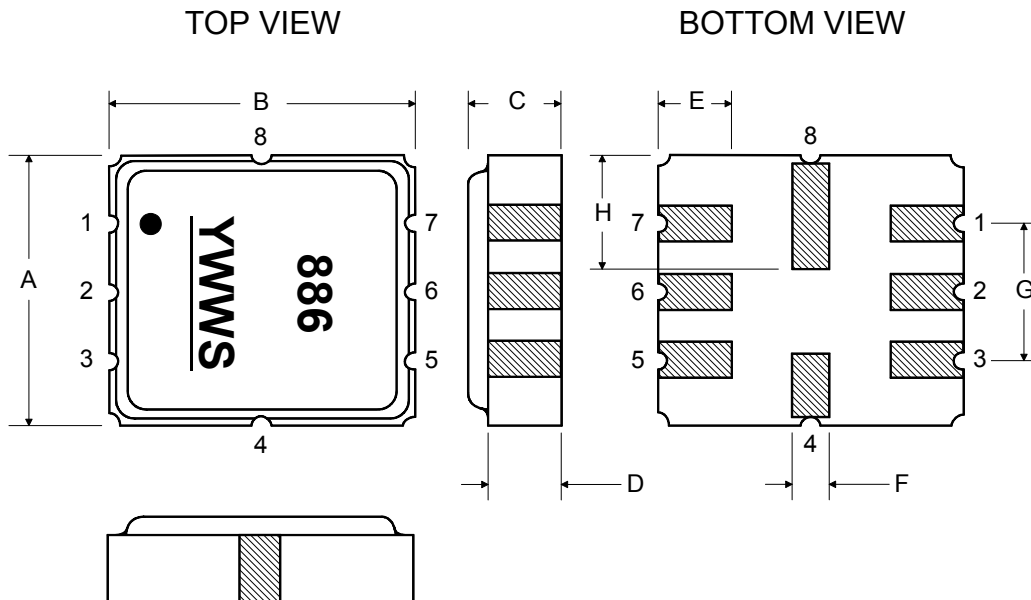

Recommended Reflow Profile

1. Preheating shall be fixed at 150~180°C for 60~90 seconds.
2. Ascending time to preheating temperature 150°C shall be 30 seconds min.
3. Heating shall be fixed at 220°C for 50~80 seconds and at 260°C +0/-5°C peak (10 seconds).
4. Time: 5 times maximum.

