

## IGBT MODULE ( L series)

### ■ Features

- High Speed Switching
- Low Saturation Voltage
- Voltage Drive

### ■ Applications

- Inverter for Motor Drive
- AC and DC Servo Drive Amplifier
- Uninterruptible Power Supply
- Industrial Machines, such as Welding Machines

### ■ Maximum Ratings and Characteristics

#### ● Absolute Maximum Ratings

Items	Symbols	Ratings	Units
Collector-Emitter Voltage	V <sub>CEs</sub>	600	V
Gate-Emitter Voltage	V <sub>GES</sub>	±20	V
Collector Current	Continuous	I <sub>C</sub>	200
	1ms	I <sub>C pulse</sub>	400
	Continuous	-I <sub>C</sub>	200
	1ms	-I <sub>C pulse</sub>	400
Max. Power Dissipation	P <sub>C</sub>	800	W
Operating Temperature	T <sub>j</sub>	+150	°C
Storage Temperature	T <sub>stg</sub>	-40 to +125	°C
Net. Weight		340	g
Isolation Voltage	AC. 1min.	V <sub>isol</sub>	2500
Screw Torque	Mounting *1	35	kg*cm
	Terminals *1	35	

\*1 Recommendable Value 25 to 35kg\*cm (M5)

#### ● Electrical Characteristics (T<sub>j</sub>=25°C)

Items	Symbols	Test Conditions	Min.	Typ.	Max.	Units
Zero Gate Voltage Collector Current	I <sub>CEs</sub>	V <sub>GE</sub> =0V V <sub>CE</sub> =600V T <sub>j</sub> =25°C			2.0	mA
Gate-Emitter Leakage Current	I <sub>GES</sub>	V <sub>CE</sub> =0V V <sub>GE</sub> =±20V			200	nA
Gate-Emitter Threshold Voltage	V <sub>GE(th)</sub>	V <sub>CE</sub> =20V I <sub>C</sub> =200mA	3.0		6.0	V
Collector-Emitter Saturation Voltage	V <sub>CE(sat)</sub>	V <sub>GE</sub> =15V I <sub>C</sub> =200A		2.7	3.5	V
Input Capacitance	C <sub>ies</sub>	V <sub>GE</sub> =0V		19000		pF
Output Capacitance	C <sub>oes</sub>	V <sub>CE</sub> =10V		-		
Reverse Transfer Capacitance	C <sub>res</sub>	f=1MHz		-		
Turn-on Time *2	t <sub>on</sub>	V <sub>CC</sub> =300V		0.6	0.8	μs
	t <sub>r</sub>	I <sub>C</sub> =200A		0.4	0.6	
Turn-off Time *3	t <sub>off</sub>	V <sub>GE</sub> =±15V		0.7	1.0	
	t <sub>f</sub>	R <sub>G</sub> =9.1Ω		0.2	0.35	
Diode Forward On-Voltage	V <sub>F</sub>	I <sub>F</sub> =200A V <sub>GE</sub> =0V			2.5	V
Reverse Recovery Time	t <sub>rr</sub>	I <sub>F</sub> =200A -di/dt=600A/μs V <sub>GE</sub> =-10V			300	ns

\*2 Resistive load

\*3 Inductive load

#### ● Thermal Characteristics

Items	Symbols	Test Conditions	Min.	Typ.	Max.	Units
Thermal Resistance	R <sub>th(j-c)</sub>	IGBT			0.156	°C/W
	R <sub>th(j-c)</sub>	Diode			0.30	
	R <sub>th(c-f)</sub>	With Thermal compound		0.025		

### ■ Outline Drawings

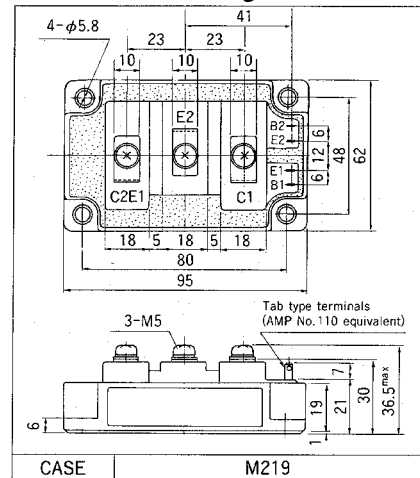

### ■ Equivallent Circuit Schematic

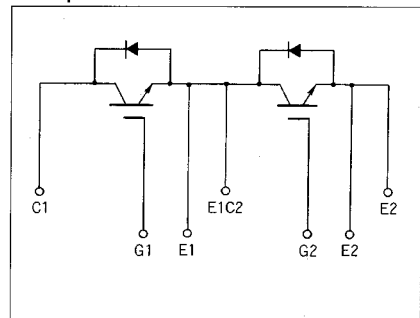

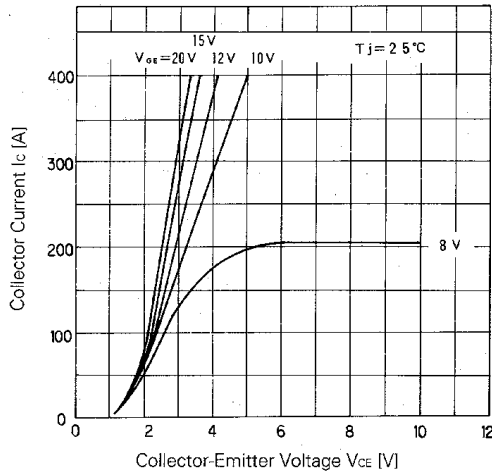

Collector Current vs. Collector-Emitter Voltage

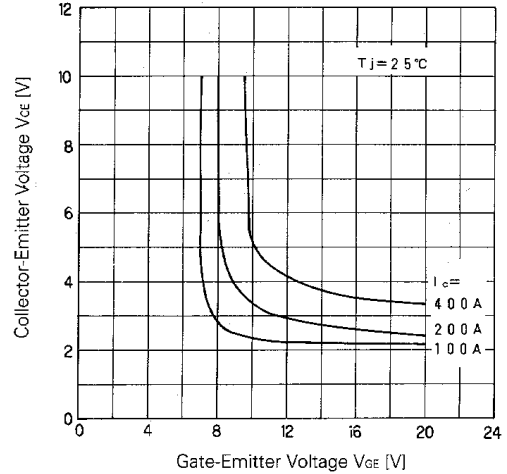

Collector-Emitter Voltage vs. Gate-Emitter Voltage

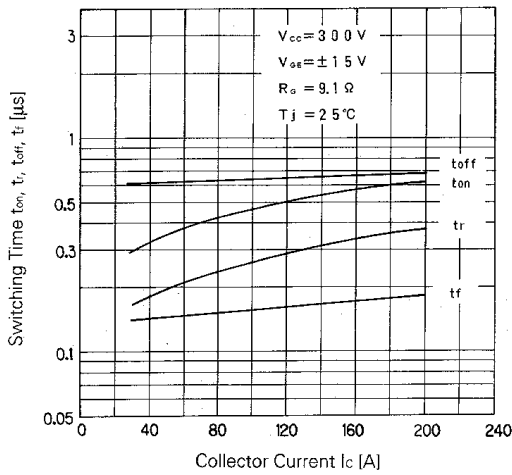

Switching Time

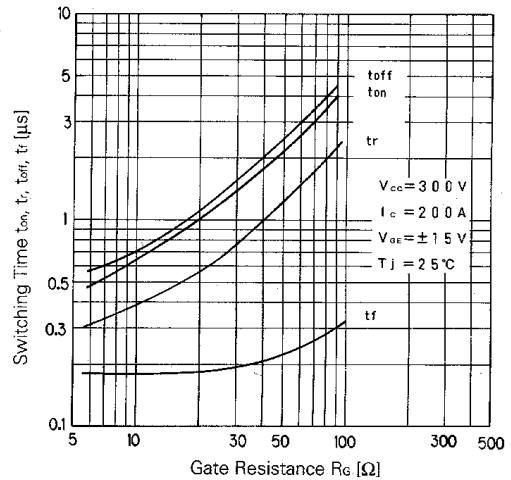

Switching Time-Gate Resistance

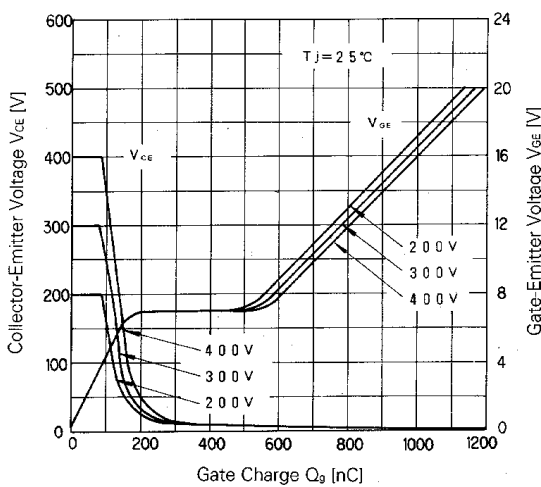

Dynamic Input Characteristic

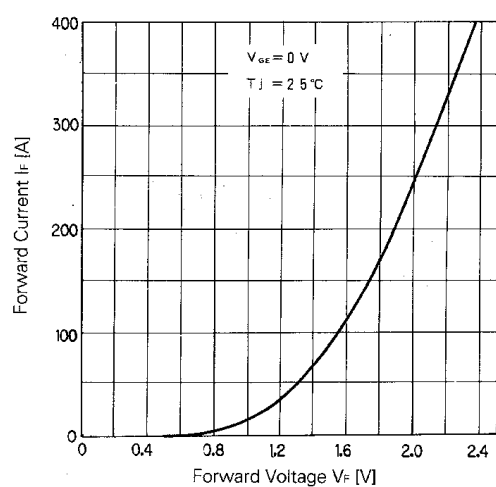

Forward Voltage of Free Wheel Diode

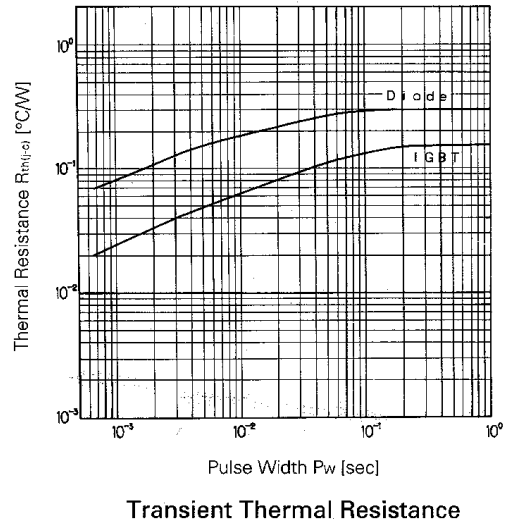
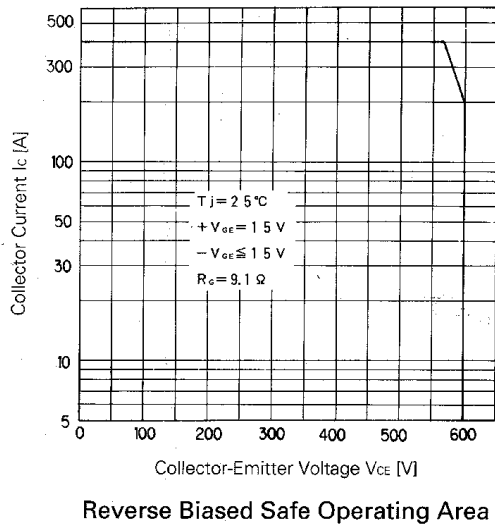
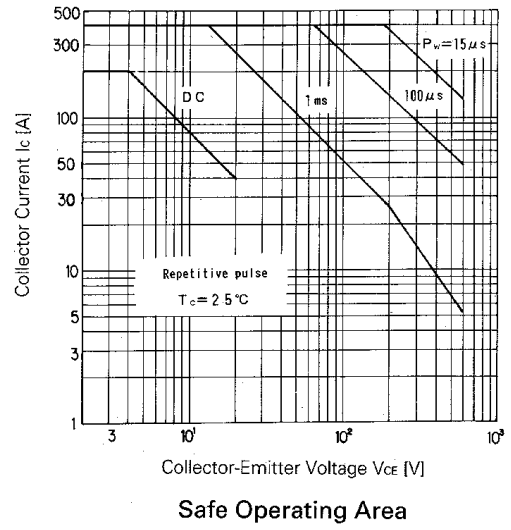
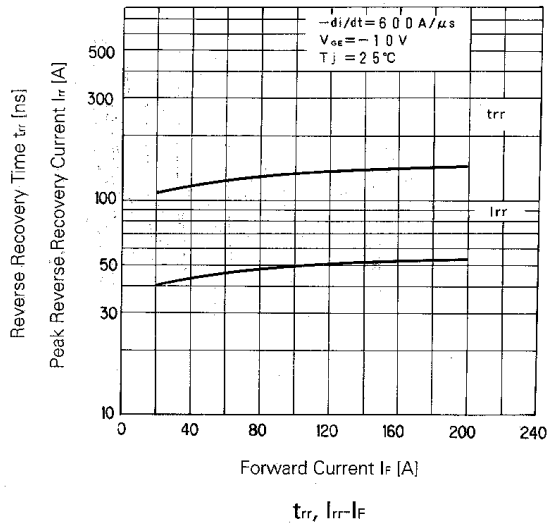

For more information, contact:

**Collmer Semiconductor, Inc.**

P.O. Box 702708

Dallas, TX 75370

972-733-1700

972-381-9991 Fax

<http://www.collmer.com>