

GaAs InGaP HBT MMIC DRIVER AMPLIFIER, 0.7 - 4.0 GHz

Typical Applications

Ideal Broadband Gain Stage for:

- 2.2 - 2.7 GHz MMDS
- 3.5 GHz Wireless Local Loop
- Low Profile Portable Wireless Devices
- WLAN Systems

Functional Diagram

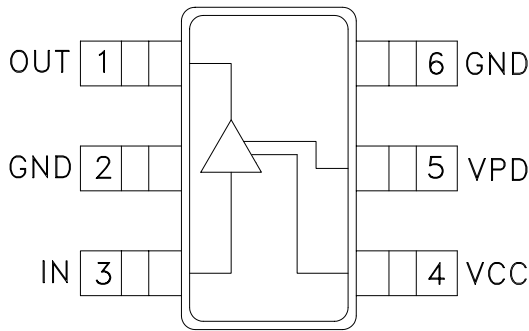

Features

- P1dB Output Power: +18 dBm
- Output IP3: +29 dBm
- Gain: 12 dB
- Single Supply: 5V
- Ultra Small Package: SOT26

General Description

The HMC314 is a GaAs InGaP Heterojunction Bipolar Transistor (HBT) MMIC amplifier that operates from a single positive supply. This amplifier also incorporates a power down feature. When the “Vpd” pin is held low, the amplifier will shut down. The surface mount SOT26 amplifier can be used as a broadband gain stage for wideband applications. The amplifier provides 12 dB of gain and +22 dBm of saturated power while operating from a single positive +5v supply. The HMC314 is packaged in an ultra small SOT26 package at a height of only 1.45mm.

Electrical Specifications, $T_A = +25^\circ C$

Parameter	Vs = +5V, Rbias = 10 Ohm			Units
	Min.	Typ.	Max.	
Frequency Range	0.7 - 4.0			GHz
Gain	7	12	16	dB
Gain Variation Over Temperature		0.015	0.025	dB/°C
Input Return Loss	6	12		dB
Output Return Loss	2	6		dB
Reverse Isolation	22	30		dB
Output Power for 1 dB Compression (P1dB) @ 1 GHz	15	18		dBm
Saturated Output Power (Psat) @ 1 GHz	19	22		dBm
Output Third Order Intercept (IP3) @ 1 GHz	26	29		dBm
Switching Speed		60		ns
Supply Current (Icc)		150		mA
Control Voltage (Vpd)		0/5		Volts
Control Current (Ipd)		.001/12		mA

GaAs InGaP HBT MMIC DRIVER AMPLIFIER, 0.7 - 4.0 GHz

Gain & Return Loss

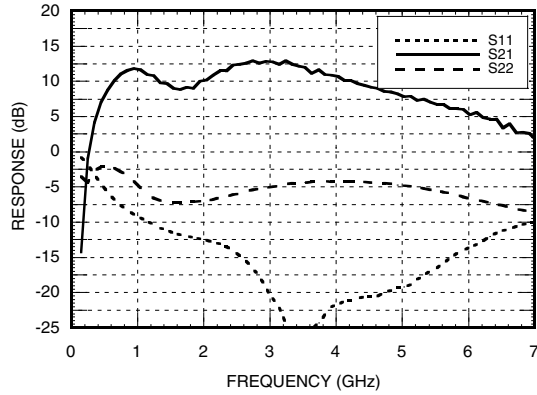

Gain vs. Temperature

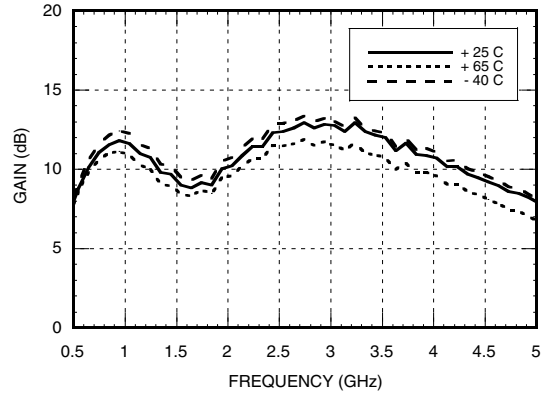

Input Return Loss vs. Temperature

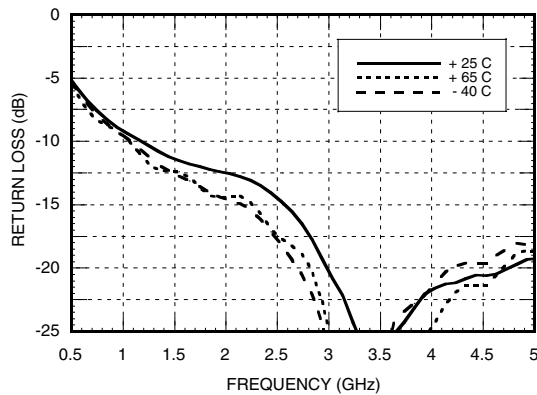

Output Return Loss vs. Temperature

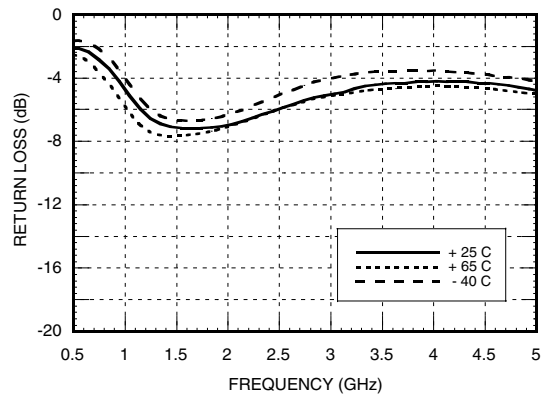

Reverse Isolation vs. Temperature

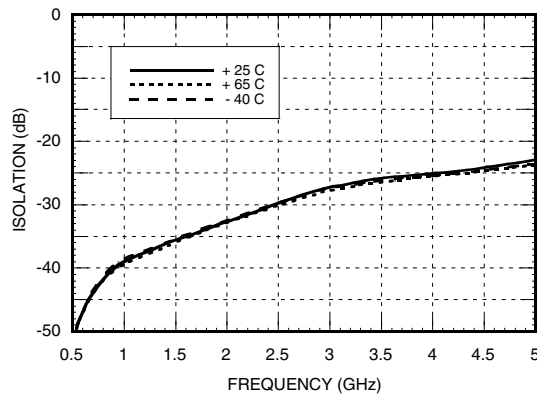

GaAs InGaP HBT MMIC DRIVER AMPLIFIER, 0.7 - 4.0 GHz

8

AMPLIFIERS - SMT

P1dB vs. Temperature

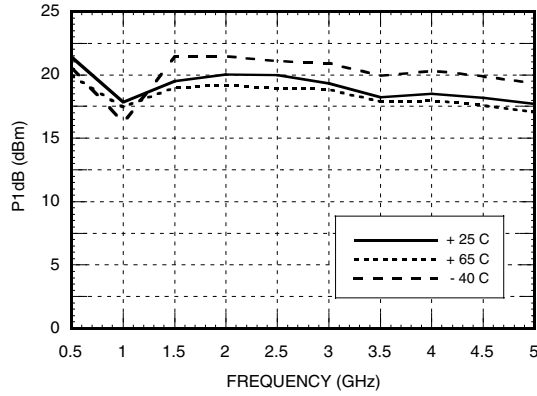

Psat vs. Temperature

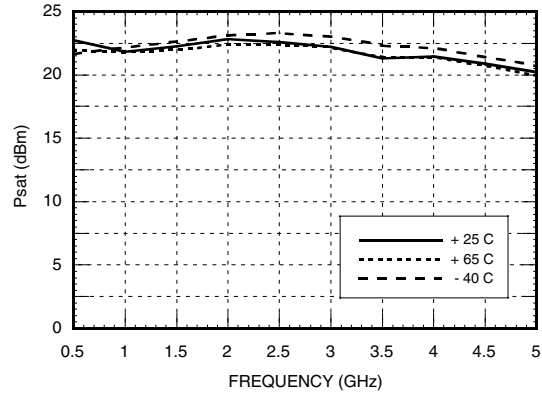

Power Compression @ 1 GHz

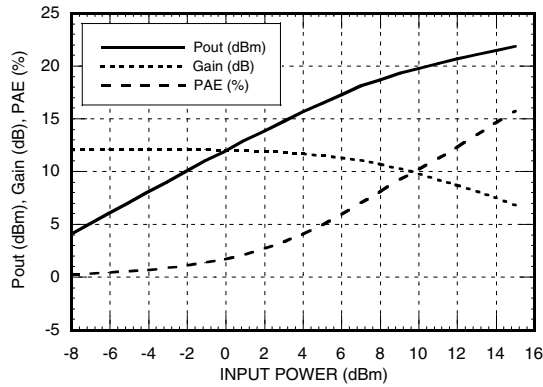

Power Compression @ 3 GHz

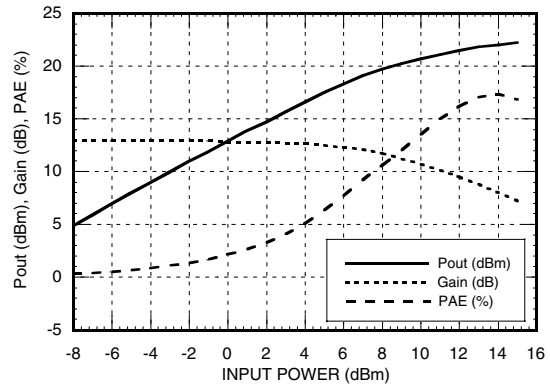

Output IP3 vs. Temperature

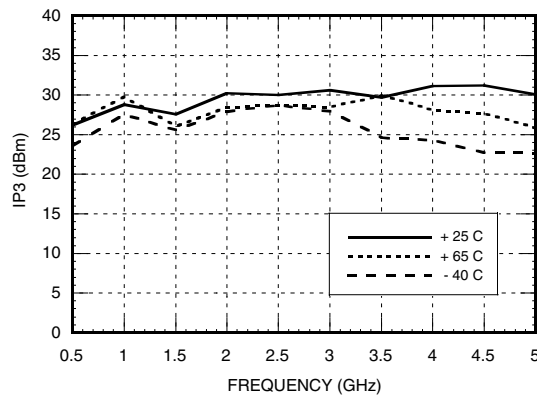

GaAs InGaP HBT MMIC DRIVER AMPLIFIER, 0.7 - 4.0 GHz

Absolute Maximum Ratings

Collector Bias Voltage (Vcc)	+5.0 Vdc
Control Voltage Range (Vpd)	-0.2 to 3.5 Vdc
RF Input Power (RFIn)(Vs = +5.0 Vdc)	+20 dBm
Junction Temperature	150 °C
Continuous P _{diss} (T = 65 °C) (derate 6.57 mW/°C above 65 °C)	0.558 W
Thermal Resistance (junction to lead)	152 °C/W
Storage Temperature	-65 to +150 °C
Operating Temperature	-40 to +65 °C



Truth Table

Vs	Vctl	Is	Ictl	State
5V	5V	150 mA	12 mA	On
5V	0V	<1 μA	<1 μA	Power Down

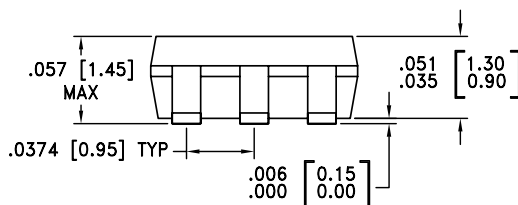
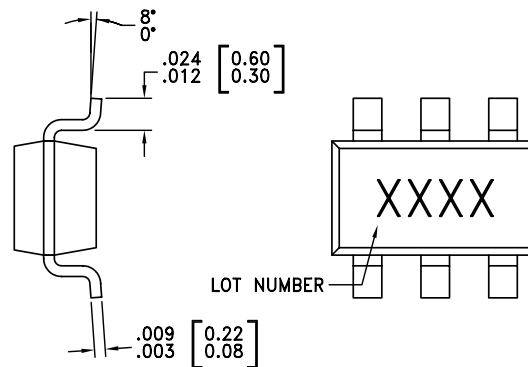
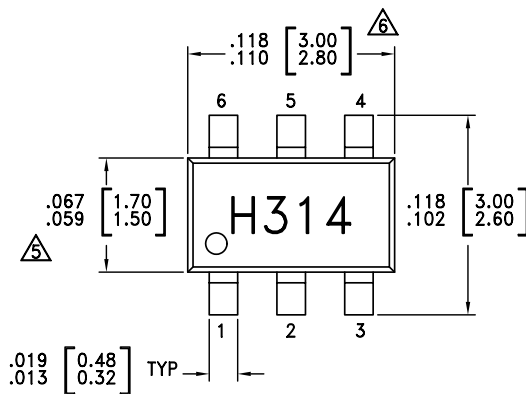
Outline Drawing



NOTES:

- PACKAGE BODY MATERIAL: LOW STRESS INJECTION MOLDED PLASTIC SILICA AND SILICON IMPREGNATED.
- LEADFRAME MATERIAL: COPPER ALLOY
- LEADFRAME PLATING: Sn/Pb SOLDER
- DIMENSIONS ARE IN INCHES [MILLIMETERS].
-  DIMENSION DOES NOT INCLUDE MOLDFLASH OF 0.15mm PER SIDE.
-  DIMENSION DOES NOT INCLUDE MOLDFLASH OF 0.25mm PER SIDE.
- ALL GROUND LEADS MUST BE SOLDERED TO PCB RF GROUND.

GaAs InGaP HBT MMIC DRIVER AMPLIFIER, 0.7 - 4.0 GHz

Application Circuit

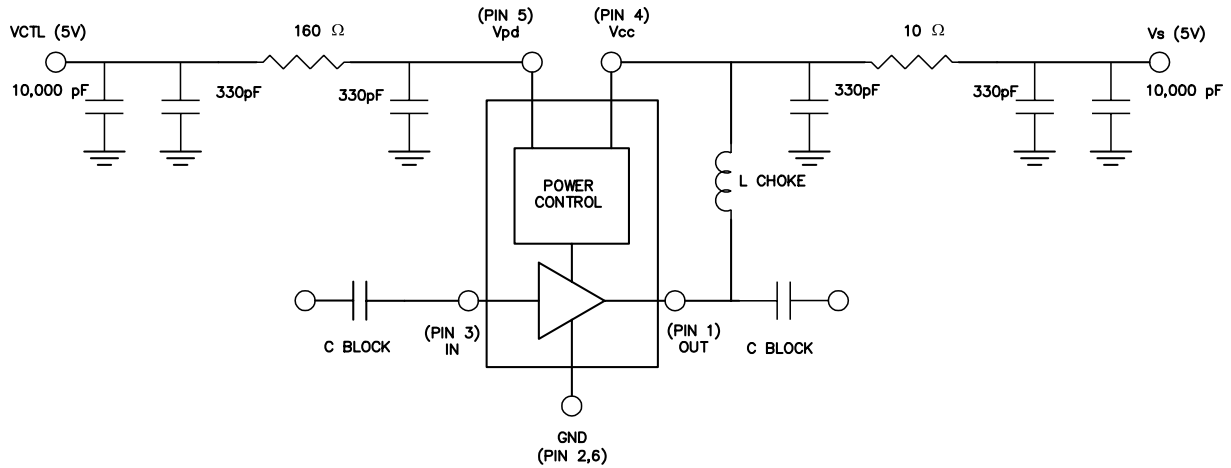

Note:

1. Requires a 10 Ohm resistor (R_{bias}) in series with the Vcc line and a 160 Ohm resistor in series with the Vpd line.
2. Requires Blocking Capacitors on Pins 1 & 3.
3. Requires bypass capacitors on Vcc and Vpd line as shown.

GaAs InGaP HBT MMIC DRIVER AMPLIFIER, 0.7 - 4.0 GHz

Evaluation PCB

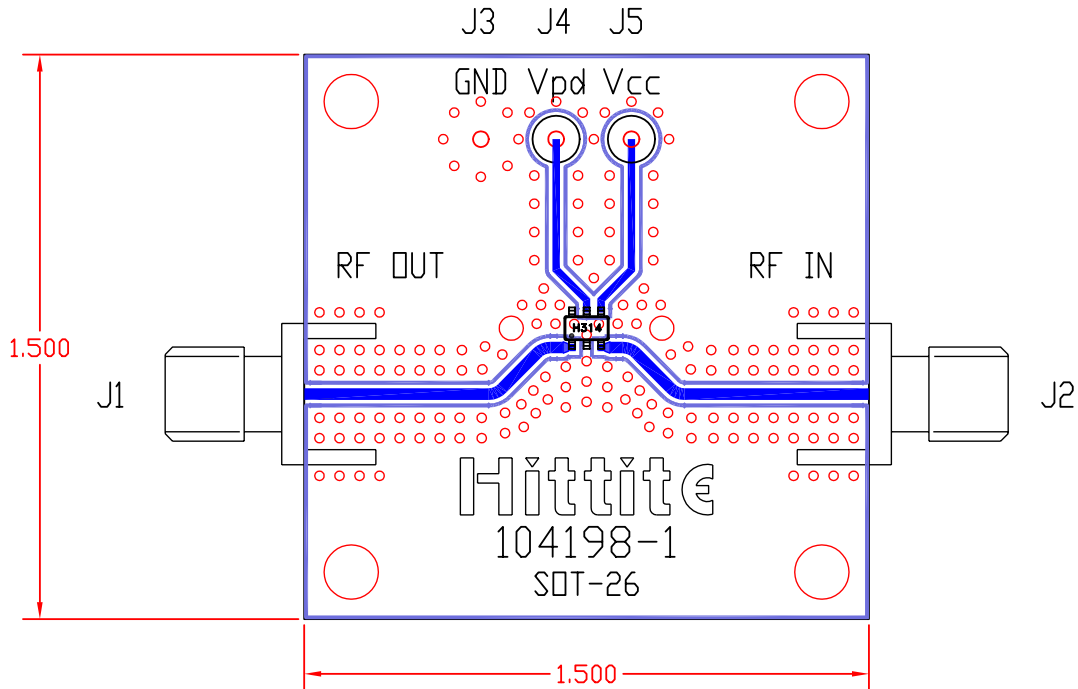

List of Material

Item	Description
J1, J2	PC Mount SMA Connector
J3, J4, J5	DC Pins
U1	HMC314
PCB*	104198 Evaluation PCB 1.5" x 1.5"
*Circuit Board Material: Roger 4350	

The circuit board used in the final application should use RF circuit design techniques. Signal lines should have 50 ohm impedance while the package ground leads should be connected directly to the ground plane similar to that shown. A sufficient number of via holes should be used to connect the top and bottom ground planes. The evaluation circuit board shown is available from Hittite upon request.

This datasheet has been download from:

www.datasheetcatalog.com

Datasheets for electronics components.