

MITSUBISHI IGBT MODULES

CM50DY-28H

MEDIUM POWER SWITCHING USE
INSULATED TYPE

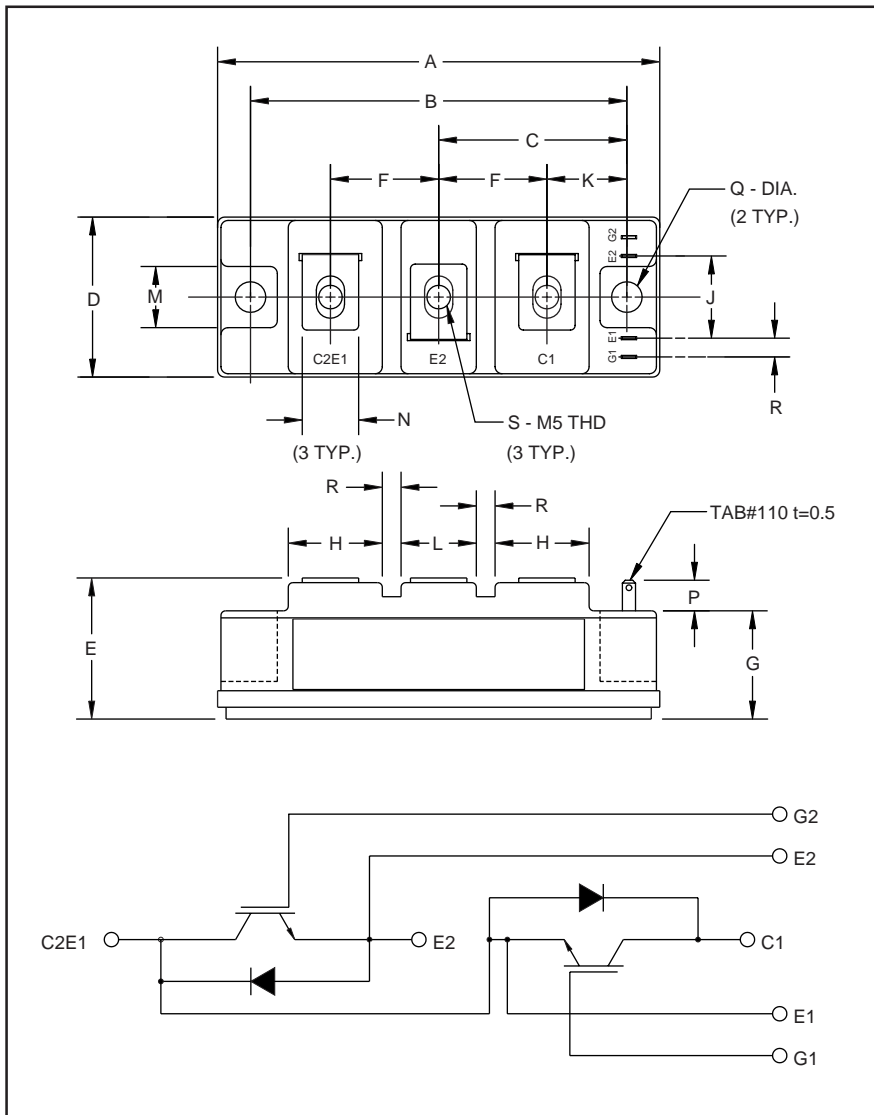

Outline Drawing and Circuit Diagram

Dimensions	Inches	Millimeters
A	3.70	94.0
B	3.150±0.01	80.0±0.25
C	1.57	40.0
D	1.34	34.0
E	1.22 Max.	31.0 Max.
F	0.90	23.0
G	0.85	21.5
H	0.79	20.0
J	0.71	18.0

Dimensions	Inches	Millimeters
K	0.67	17.0
L	0.63	16.0
M	0.51	13.0
N	0.47	12.0
P	0.28	7.0
Q	0.256 Dia.	Dia. 6.5
R	0.16	4.0
S	M5 Metric	M5



Description:

Mitsubishi IGBT Modules are designed for use in switching applications. Each module consists of two IGBTs in a half-bridge configuration with each transistor having a reverse-connected super-fast recovery free-wheel diode. All components and interconnects are isolated from the heat sinking baseplate, offering simplified system assembly and thermal management.

Features:

- Low Drive Power
- Low $V_{CE(sat)}$
- Discrete Super-Fast Recovery Free-Wheel Diode
- High Frequency Operation
- Isolated Baseplate for Easy Heat Sinking

Applications:

- AC Motor Control
- Motion/Servo Control
- UPS
- Welding Power Supplies

Ordering Information:

Example: Select the complete part module number you desire from the table below -i.e. CM50DY-28H is a 1400V- (V_{CES}) , 50 Ampere Dual IGBT Module.

Type	Current Rating Amperes	V_{CES} Volts (x 50)
CM	50	28

CM50DY-28H

MEDIUM POWER SWITCHING USE
INSULATED TYPEAbsolute Maximum Ratings, $T_j = 25\text{ }^\circ\text{C}$ unless otherwise specified

	Symbol	Ratings	Units
Junction Temperature	T_j	-40 to 150	$^\circ\text{C}$
Storage Temperature	T_{stg}	-40 to 125	$^\circ\text{C}$
Collector-Emitter Voltage (G-E SHORT)	V_{CES}	1400	Volts
Gate-Emitter Voltage (C-E SHORT)	V_{GES}	± 20	Volts
Collector Current ($T_C = 25\text{ }^\circ\text{C}$)	I_C	50	Amperes
Peak Collector Current	I_{CM}	100*	Amperes
Emitter Current** ($T_C = 25\text{ }^\circ\text{C}$)	I_E	50	Amperes
Peak Emitter Current**	I_{EM}	100*	Amperes
Maximum Collector Dissipation ($T_C = 25\text{ }^\circ\text{C}$, $T_j \leq 150\text{ }^\circ\text{C}$)	P_c	400	Watts
Mounting Torque, M5 Main Terminal	-	1.47 ~ 1.96	N · m
Mounting Torque, M6 Mounting	-	1.96 ~ 2.94	N · m
Weight	-	190	Grams
Isolation Voltage (Main Terminal to Baseplate, AC 1 min.)	V_{iso}	2500	Vrms

*Pulse width and repetition rate should be such that the device junction temperature (T_j) does not exceed $T_{j(max)}$ rating.

**Represents characteristics of the anti-parallel, emitter-to-collector free-wheel diode (FWDi).

Static Electrical Characteristics, $T_j = 25\text{ }^\circ\text{C}$ unless otherwise specified

Characteristics	Symbol	Test Conditions	Min.	Typ.	Max.	Units
Collector-Cutoff Current	I_{CES}	$V_{CE} = V_{CES}$, $V_{GE} = 0V$	-	-	1.0	mA
Gate Leakage Current	I_{GES}	$V_{GE} = V_{GES}$, $V_{CE} = 0V$	-	-	0.5	μA
Gate-Emitter Threshold Voltage	$V_{GE(th)}$	$I_C = 5\text{mA}$, $V_{CE} = 10V$	5.0	6.5	8.0	Volts
Collector-Emitter Saturation Voltage	$V_{CE(sat)}$	$I_C = 50\text{A}$, $V_{GE} = 15V$	-	3.1	4.2**	Volts
		$I_C = 50\text{A}$, $V_{GE} = 15V$, $T_j = 150\text{ }^\circ\text{C}$	-	2.95	-	Volts
Total Gate Charge	Q_G	$V_{CC} = 800V$, $I_C = 50\text{A}$, $V_{GE} = 15V$	-	255	-	nC
Emitter-Collector Voltage	V_{EC}	$I_E = 50\text{A}$, $V_{GE} = 0V$	-	-	3.8	Volts

** Pulse width and repetition rate should be such that device junction temperature rise is negligible.

Dynamic Electrical Characteristics, $T_j = 25\text{ }^\circ\text{C}$ unless otherwise specified

Characteristics	Symbol	Test Conditions	Min.	Typ.	Max.	Units
Input Capacitance	C_{ies}		-	-	10	nF
Output Capacitance	C_{oes}	$V_{GE} = 0V$, $V_{CE} = 10V$	-	-	3.5	nF
Reverse Transfer Capacitance	C_{res}		-	-	2.0	nF
Resistive	Turn-on Delay Time	$V_{CC} = 800V$, $I_C = 50\text{A}$, $V_{GE1} = V_{GE2} = 15V$, $R_G = 6.3\Omega$	-	-	100	ns
	Load					
Switching	Turn-off Delay Time	$V_{CC} = 800V$, $I_C = 50\text{A}$, $V_{GE1} = V_{GE2} = 15V$, $R_G = 6.3\Omega$	-	-	150	ns
	Times					
Diode Reverse Recovery Time	t_{rr}	$I_E = 50\text{A}$, $di_E/dt = -100\text{A}/\mu\text{s}$	-	-	300	ns
Diode Reverse Recovery Charge	Q_{rr}	$I_E = 50\text{A}$, $di_E/dt = -100\text{A}/\mu\text{s}$	-	0.5	-	μC

Thermal and Mechanical Characteristics, $T_j = 25\text{ }^\circ\text{C}$ unless otherwise specified

Characteristics	Symbol	Test Conditions	Min.	Typ.	Max.	Units
Thermal Resistance, Junction to Case	$R_{th(j-c)}$	Per IGBT	-	-	0.31	$^\circ\text{C}/W$
Thermal Resistance, Junction to Case	$R_{th(j-c)}$	Per FWDi	-	-	0.70	$^\circ\text{C}/W$
Contact Thermal Resistance	$R_{th(c-f)}$	Per Module, Thermal Grease Applied	-	-	0.075	$^\circ\text{C}/W$

CM50DY-28H

MEDIUM POWER SWITCHING USE
INSULATED TYPE

OUTPUT CHARACTERISTICS (TYPICAL)

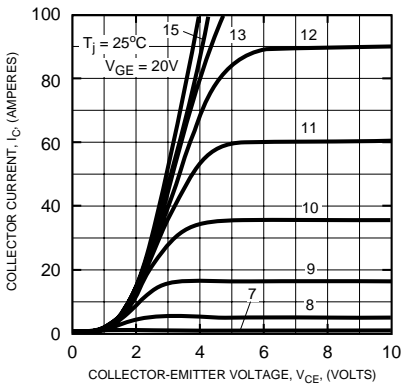

TRANSFER CHARACTERISTICS (TYPICAL)

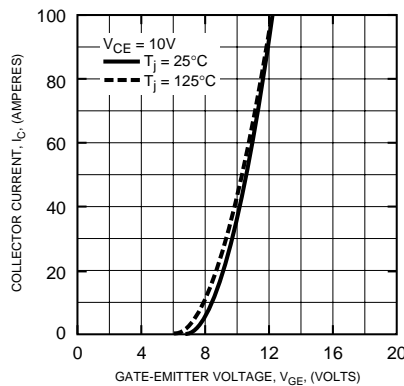

COLLECTOR-EMITTER SATURATION VOLTAGE CHARACTERISTICS (TYPICAL)

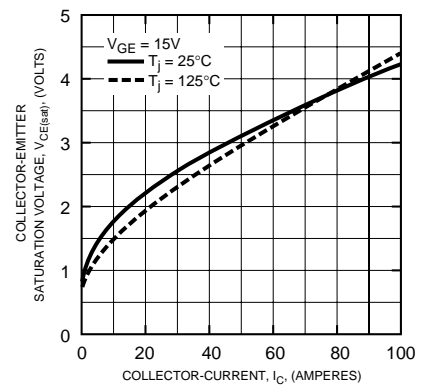

COLLECTOR-EMITTER SATURATION VOLTAGE CHARACTERISTICS (TYPICAL)

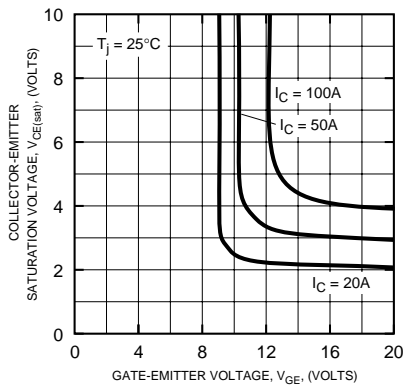

FREE-WHEEL DIODE FORWARD CHARACTERISTICS (TYPICAL)

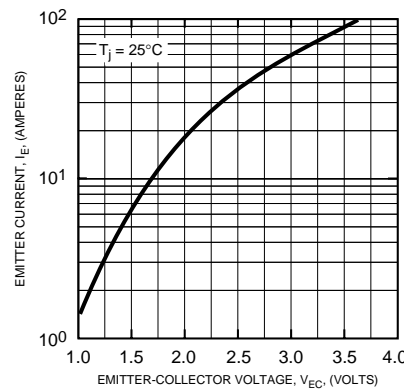

CAPACITANCE VS. VCE (TYPICAL)

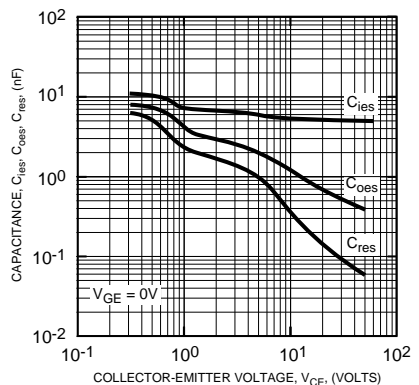

HALF-BRIDGE SWITCHING CHARACTERISTICS (TYPICAL)

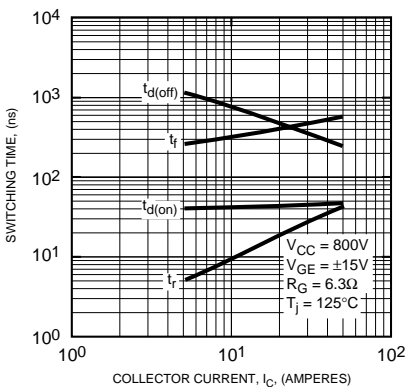

REVERSE RECOVERY CHARACTERISTICS (TYPICAL)

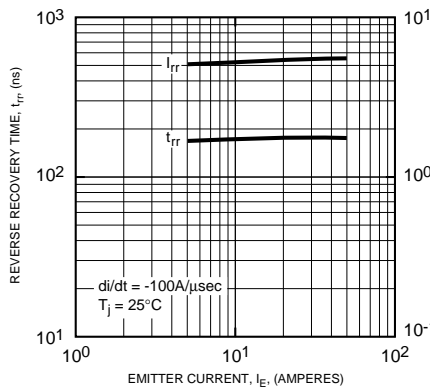

GATE CHARGE, VGE

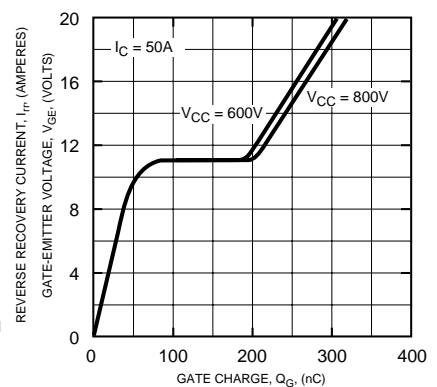

CM50DY-28H

MEDIUM POWER SWITCHING USE
INSULATED TYPE

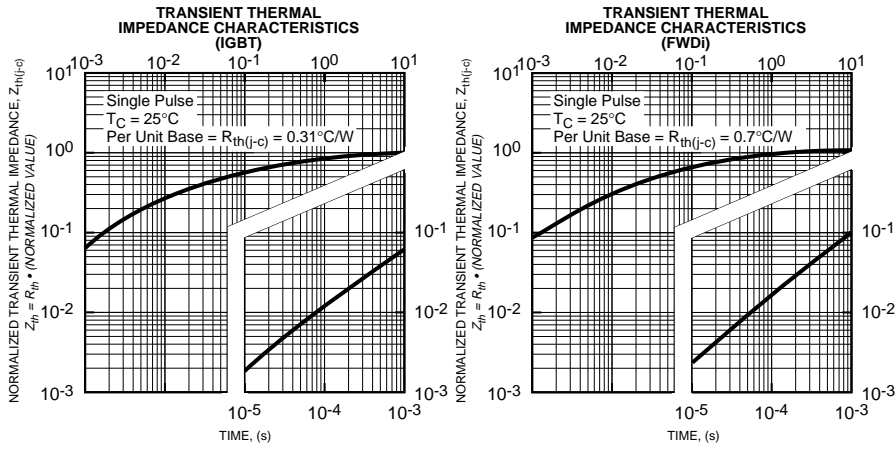

This datasheet has been download from:

www.datasheetcatalog.com

Datasheets for electronics components.