

Transient Voltage Suppressor



Features:

- Optimized for LAN Protection Applications
- Low Profile Package With Built-In Strain Relief For Surface Mounted Applications
- Low Incremental Surge Resistance, Excellent Clamping Capability
- 400W Peak Pulse Power Capability with a 10/1,000 μ s Wave Form, Repetition Rate (duty cycle): 0.01% (300W above 78V)
- Very Fast Response Time
- High Temperature Soldering Guaranteed : 260°C/10 seconds at Terminals

Mechanical Data

- Case : JEDEC DO-214AC molded plastic over passivated chip
- Terminals : solder plated, solderable per MIL-STD-750, method 2026
- Polarity : front-directional types the colour band denotes the cathode, which is positive with respect to the anode under normal TVS operation
- Mounting position: any Weight : 0.002oz, 0.064g

Devices for Bidirectional Applications

For Bi-directional devices, use suffix C or CA (e.g. SMAJ10C, SMAJ10CA). Electrical characteristics apply in both directions.

Maximum Ratings and Thermal Characteristics ($T_A=25^\circ\text{C}$ unless otherwise noted)

Characteristic	Symbol	Value	Unit
Peak power dissipation with a 10/1,000 μ s waveform (Note 1,2, Fig.1)	P _{PPM}	Min. 400	W
Peak pulse current with a 10/1,000 μ s waveform (Note 1)	I _{PPM}	See Next Table	A
Typical thermal resistance, junction to ambient (Note 3)	R _{θJA}	120	°C/W
Peak forward surge current, 8.3ms single half sine-wave uni-directional only (Note 2)	I _{FSM}	40	A
Typical thermal resistance, junction to ambient (Note 3)	R _{θJL}	30	°C/W
Operating junction and storage temperature range	T _J , T _{STG}	-55 to +150	°C

Note:

- (1) Non-repetitive current pulses, per Fig. 3 and derate above $T_A=25$ per Fig. 2. Rating is 300W above 78V.
- (2) Mounted on 0.2" \times 0.2" (5mm \times 5mm) copper pads to each terminal.
- (3) Mounted on minimum recommended pad layout

Transient Voltage Suppressor

Electrical Characteristics (T_A = 25°C)

Part Number	Device Marking code		Dynamic			V _{WM}	I _{RM}	IPPM	V _C
	UNI	BI	V		@I _T				
			Min.	Max.	mA	V	uA	A	V
SMAJ6.5A-13-F	AAH	AWH	7.22	8.82	10	6.5	500	32.5	12.3
SMAJ6.5CA-13-F	AAK	AWK	7.22	7.98	10	6.5	500	35.7	11.2
SMAJ10A-13-F	AAX	AWX	11.1	12.3	1	10	5	23.5	17
SMAJ11CA-13-F	AAZ	AWZ	12.2	13.5	1	11	5	22	18.2
SMAJ15CA-13-F	ABM	AXM	16.7	18.5	1	15	5	16.4	24.4
SMAJ16A-13-F	ABP	AXP	17.8	19.7	1	16	5	15.4	26
SMAJ17A-13-F	ABR	AXR	18.9	20.9	1	17	5	14.5	27.6
SMAJ20A-13-F	ABV	AXV	22.2	24.5	1	20	5	12.3	32.4
SMAJ22A-13-F	ABX	AXX	24.4	26.9	1	22	5	11.3	35.5
SMAJ24CA-13-F	ABZ	AXZ	26.7	29.5	1	24	5	10.3	38.9
SMAJ33A-13-F	ACM	AYM	36.7	40.6	1	33	5	5.6	53.3
SMAJ43CA-13-F	ACT	AYT	47.8	52.8	1	43	5	4.3	69.4
SMAJ60A-13-F	ARK	AZK	66.7	73.7	1	60	5	3.1	96.8
SMAJ60A-13-F	ART	AZT	86.7	95.8	1	78	5	2.4	126
SMAJ78CA-13-F	ART	AZT	86.7	95.8	1	78	5	2.4	126
SMAJ160A-13-F	ASP	AVP	178	197	1	160	5	1.2	259

FIG.1 – PEAK PULSE POWER RATING CURVE

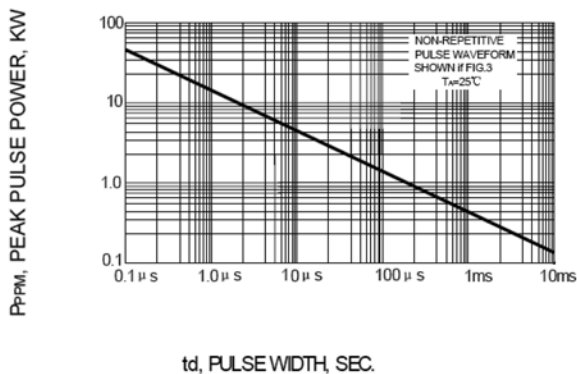
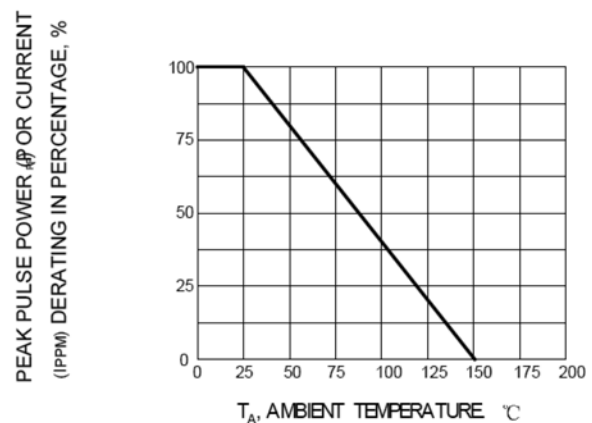

FIG.2 – PULSE DERATING CURVE



Transient Voltage Suppressor

FIG.3 – PULSE WAVEFORM

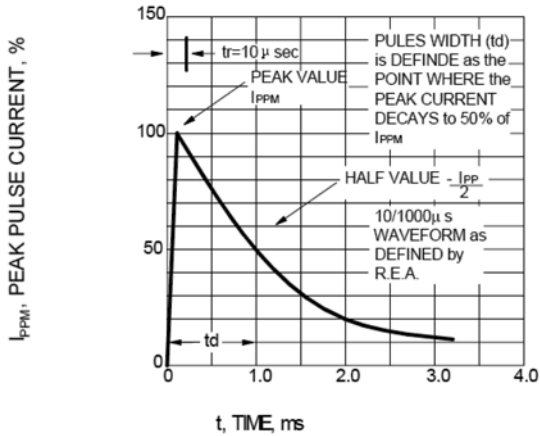

FIG.4 – TYPICAL JUNCTION CAPACITANCE UNIDIRECTIONAL

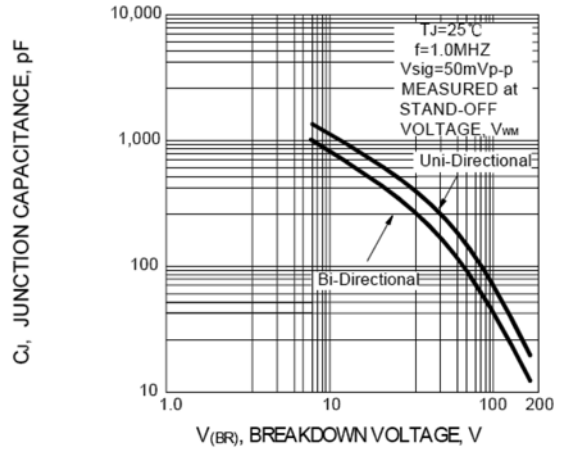

FIG.5 – TYPICAL TRANSIENT THERMAL IMPEDANCE

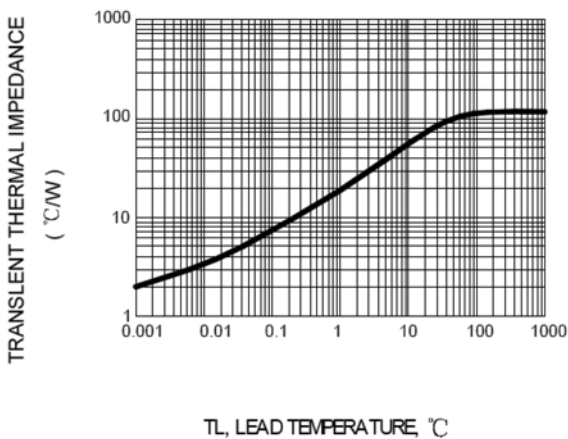
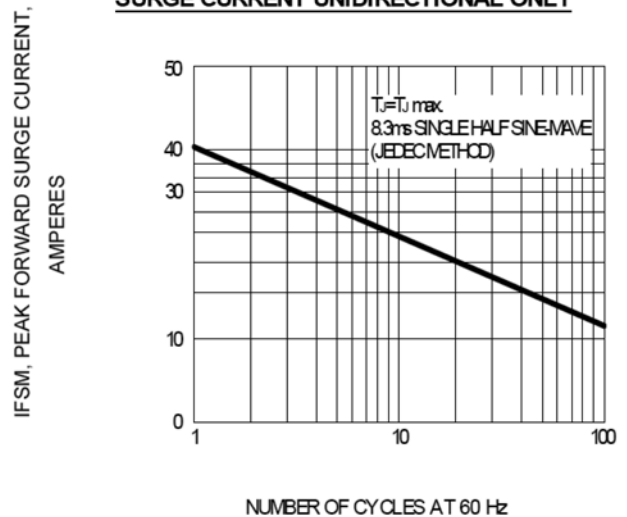
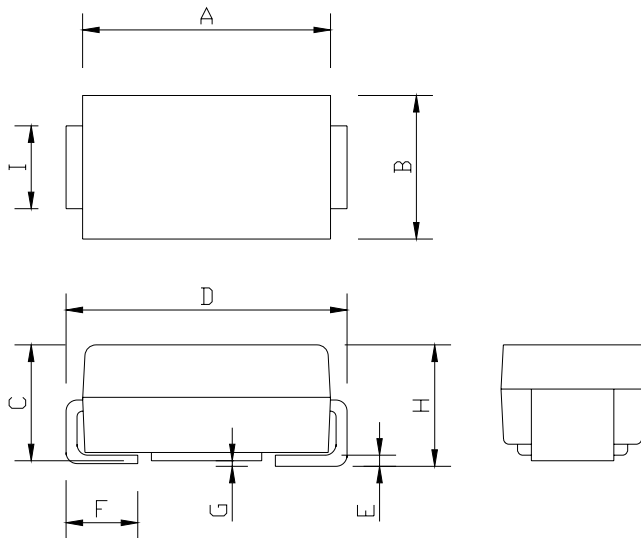

FIG.6 – MAXIMUM NON-REPETITIVE FORWARD SURGE CURRENT UNIDIRECTIONAL ONLY



Transient Voltage Suppressor

Package Outline Dimensions



DO-214AC(SMA)		
Dim.	Min.	Max.
A	4.25	4.65
B	2.4	2.8
C	1.85	2.15
D	4.85	5.35
E	0.2 Typ.	
F	0.9	1.5
G	0.2 Max.	
H	1.9	2.3
I	1.35	1.65

Dimensions : Millimetres

Soldering Footprint

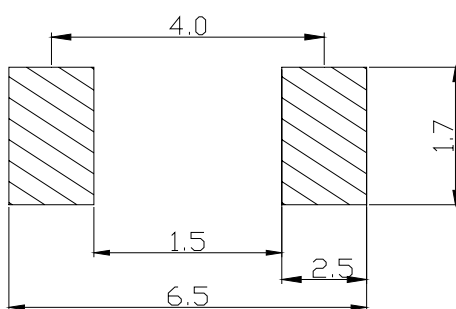

Dimensions : Millimetres

Package Information

Device	Package	Shipping
SMAJ6.5A-13-F	DO-214AC(SMA)	5,000 / Tape & Reel
SMAJ6.5CA-13-F		
SMAJ10A-13-F		
SMAJ11CA-13-F		
SMAJ15CA-13-F		
SMAJ16A-13-F		
SMAJ17A-13-F		
SMAJ20A-13-F		
SMAJ22A-13-F		
SMAJ24CA-13-F		
SMAJ33A-13-F		
SMAJ43CA-13-F		
SMAJ60A-13-F		
SMAJ60A-13-F		
SMAJ78CA-13-F		
SMAJ160A-13-F		

Transient Voltage Suppressor

Part Number Table

Description	Part Number
Transient Voltage Suppressor	SMAJ6.5A-13-F
	SMAJ6.5CA-13-F
	SMAJ10A-13-F
	SMAJ11CA-13-F
	SMAJ15CA-13-F
	SMAJ16A-13-F
	SMAJ17A-13-F
	SMAJ20A-13-F
	SMAJ22A-13-F
	SMAJ24CA-13-F
	SMAJ33A-13-F
	SMAJ43CA-13-F
	SMAJ60A-13-F
	SMAJ60A-13-F
	SMAJ78CA-13-F
SMAJ160A-13-F	

Important Notice : This data sheet and its contents (the "Information") belong to the members of the Premier Farnell group of companies (the "Group") or are licensed to it. No licence is granted for the use of it other than for information purposes in connection with the products to which it relates. No licence of any intellectual property rights is granted. The Information is subject to change without notice and replaces all data sheets previously supplied. The Information supplied is believed to be accurate but the Group assumes no responsibility for its accuracy or completeness, any error in or omission from it or for any use made of it. Users of this data sheet should check for themselves the Information and the suitability of the products for their purpose and not make any assumptions based on information included or omitted. Liability for loss or damage resulting from any reliance on the Information or use of it (including liability resulting from negligence or where the Group was aware of the possibility of such loss or damage arising) is excluded. This will not operate to limit or restrict the Group's liability for death or personal injury resulting from its negligence. Multicomp is the registered trademark of the Group. © Premier Farnell plc 2012.

www.element14.com
www.farnell.com
www.newark.com

