

Pb Free Plating Product

MJ21195G/MJ21196G



250 Watt Silicon Type Metal Package Power Transistor

The MJ21195 and MJ21196 utilize Perforated Emitter technology and are specifically designed for high power audio output, disk head positioners and linear applications.

- Total Harmonic Distortion Characterized
- High DC Current Gain – $h_{FE} = 25$ Min @ $I_C = 8$ Adc
- Excellent Gain Linearity
- High SOA: 3 A, 80 V, 1 Second

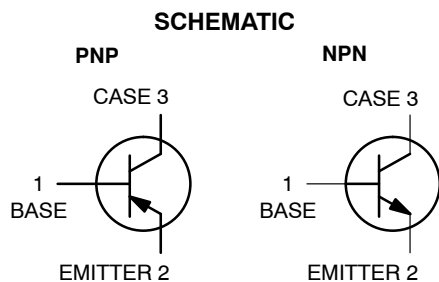
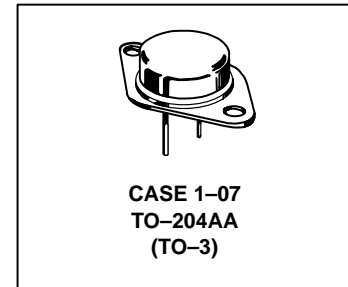

MAXIMUM RATINGS

Rating	Symbol	Value	Unit
Collector–Emitter Voltage	V_{CEO}	250	Vdc
Collector–Base Voltage	V_{CBO}	400	Vdc
Emitter–Base Voltage	V_{EBO}	5	Vdc
Collector–Emitter Voltage – 1.5 V	V_{CEX}	400	Vdc
Collector Current — Continuous Peak (1)	I_C	16 30	Adc
Base Current — Continuous	I_B	5	Adc
Total Power Dissipation @ $T_C = 25^\circ\text{C}$ Derate Above 25°C	P_D	250 1.43	Watts W/ $^\circ\text{C}$
Operating and Storage Junction Temperature Range	T_J, T_{stg}	– 65 to +200	$^\circ\text{C}$

THERMAL CHARACTERISTICS

Characteristic	Symbol	Max	Unit
Thermal Resistance, Junction to Case	$R_{\theta JC}$	0.7	$^\circ\text{C}/\text{W}$

ELECTRICAL CHARACTERISTICS ($T_C = 25^\circ\text{C} \pm 5^\circ\text{C}$ unless otherwise noted)

Characteristic	Symbol	Min	Typical	Max	Unit
Collector–Emitter Sustaining Voltage ($I_C = 100$ mAdc, $I_B = 0$)	$V_{CEO(sus)}$	250	—	—	Vdc
Collector Cutoff Current ($V_{CE} = 200$ Vdc, $I_B = 0$)	I_{CEO}	—	—	100	μAdc

(1) Pulse Test: Pulse Width = 5 μs , Duty Cycle $\leq 10\%$.

(continued)

ELECTRICAL CHARACTERISTICS (T_C = 25°C unless otherwise noted)

Characteristic	Symbol	Min	Typical	Max	Unit
OFF CHARACTERISTICS					
Emitter Cutoff Current (V _{CE} = 5 Vdc, I _C = 0)	I _{EBO}	—	—	100	μA _{dc}
Collector Cutoff Current (V _{CE} = 250 Vdc, V _{BE(off)} = 1.5 Vdc)	I _{CEX}	—	—	100	μA _{dc}
SECOND BREAKDOWN					
Second Breakdown Collector Current with Base Forward Biased (V _{CE} = 50 Vdc, t = 1 s (non-repetitive) (V _{CE} = 80 Vdc, t = 1 s (non-repetitive))	I _{S/b}	5 2.5	— —	— —	A _{dc}
ON CHARACTERISTICS					
DC Current Gain (I _C = 8 A _{dc} , V _{CE} = 5 Vdc) (I _C = 16 A _{dc} , V _{CE} = 5 Vdc)	h _{FE}	25 8	— —	75	
Base-Emitter On Voltage (I _C = 8 A _{dc} , V _{CE} = 5 Vdc)	V _{BE(on)}	—	—	2.2	V _{dc}
Collector-Emitter Saturation Voltage (I _C = 8 A _{dc} , I _B = 0.8 A _{dc}) (I _C = 16 A _{dc} , I _B = 3.2 A _{dc})	V _{CE(sat)}	— —	— —	1.4 4	V _{dc}
DYNAMIC CHARACTERISTICS					
Total Harmonic Distortion at the Output V _{RMS} = 28.3 V, f = 1 kHz, P _{LOAD} = 100 W _{RMS} (Matched pair h _{FE} = 50 @ 5 A/5 V)	h _{FE} unmatched h _{FE} matched	— —	0.8 0.08	— —	%
Current Gain Bandwidth Product (I _C = 1 A _{dc} , V _{CE} = 10 Vdc, f _{test} = 1 MHz)	f _T	4	—	—	MHz
Output Capacitance (V _{CB} = 10 Vdc, I _E = 0, f _{test} = 1 MHz)	C _{ob}	—	—	500	pF

(1) Pulse Test: Pulse Width = 300 μs, Duty Cycle ≤ 2%

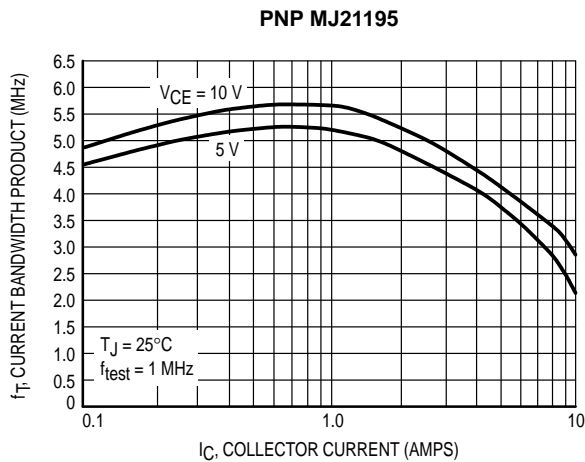

Figure 1. Typical Current Gain Bandwidth Product

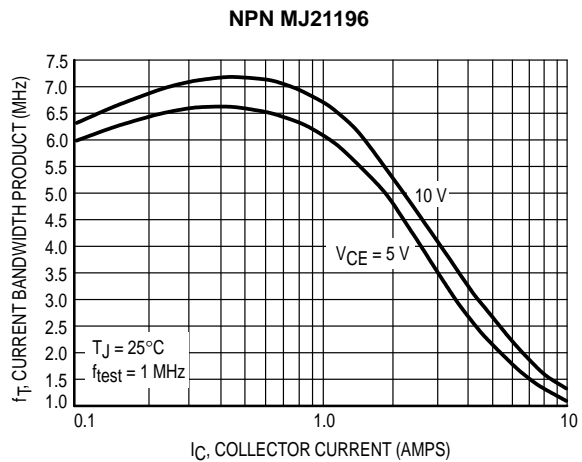

Figure 2. Typical Current Gain Bandwidth Product

PNP MJ21195

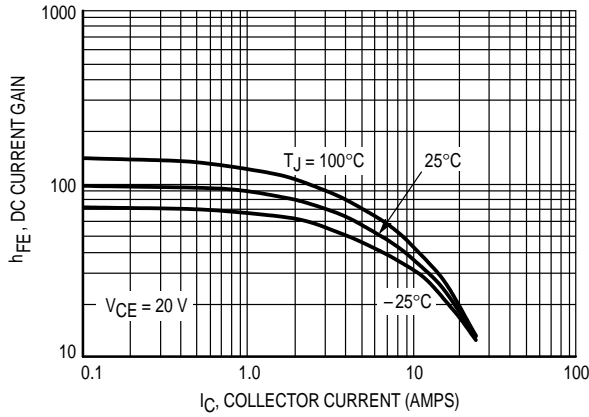

Figure 3. DC Current Gain, $V_{CE} = 20\text{ V}$

NPN MJ21196

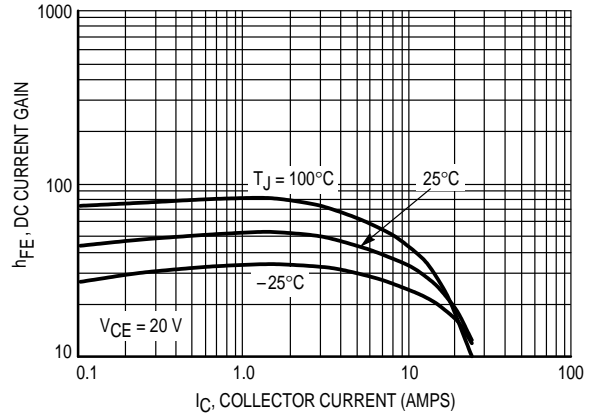

Figure 4. DC Current Gain, $V_{CE} = 20\text{ V}$

PNP MJ21195

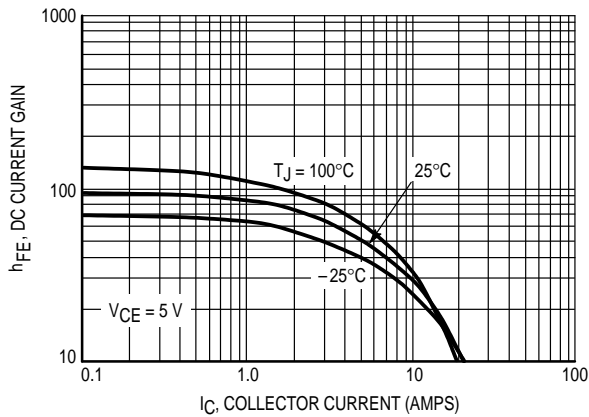

Figure 5. DC Current Gain, $V_{CE} = 5\text{ V}$

NPN MJ21196

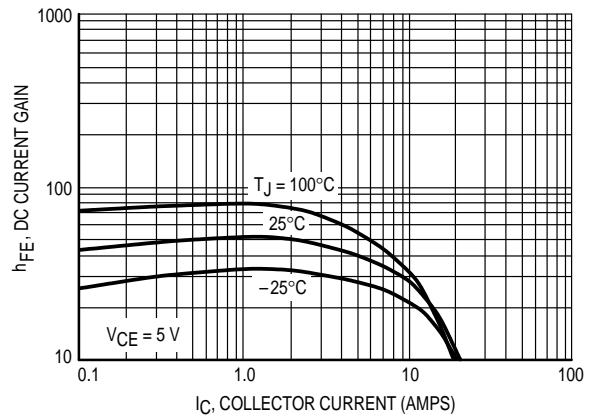

Figure 6. DC Current Gain, $V_{CE} = 5\text{ V}$

PNP MJ21195

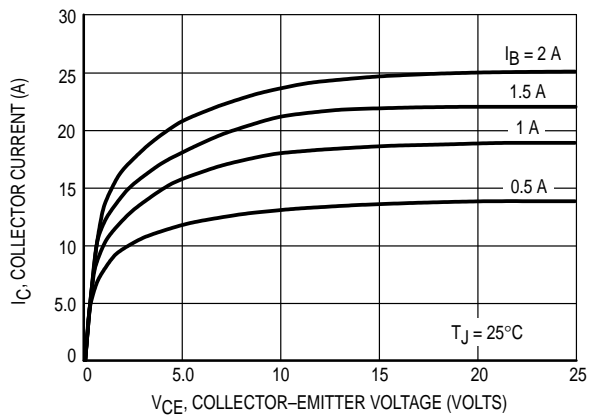

Figure 7. Typical Output Characteristics

NPN MJ21196

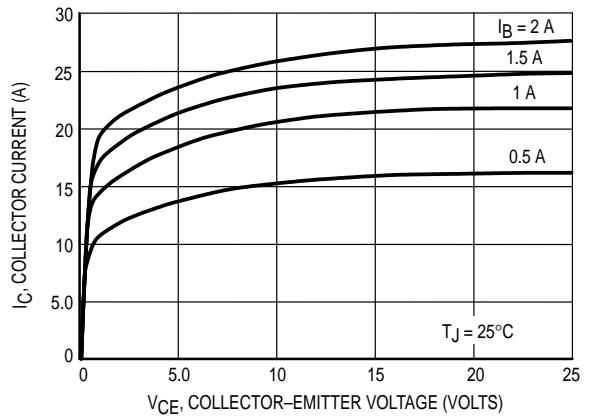

Figure 8. Typical Output Characteristics

TYPICAL CHARACTERISTICS

PNP MJ21195

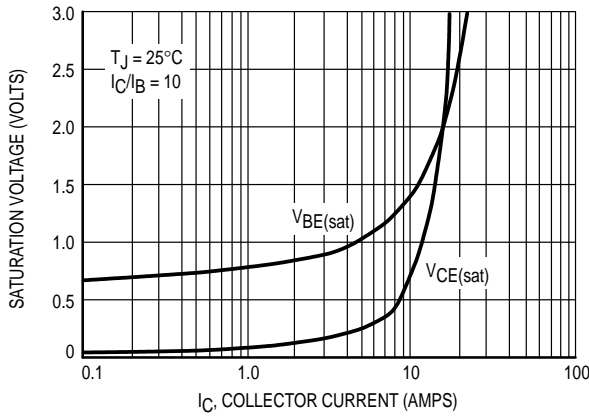

Figure 9. Typical Saturation Voltages

NPN MJ21196

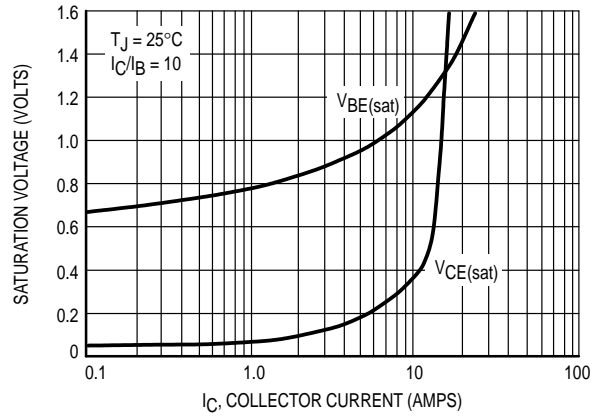

Figure 10. Typical Saturation Voltages

PNP MJ21195

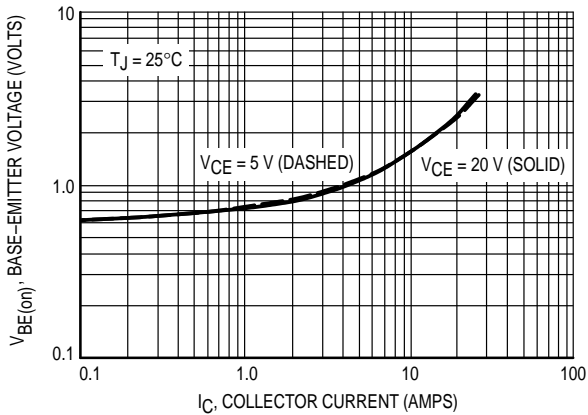

Figure 11. Typical Base-Emitter Voltage

NPN MJ21196

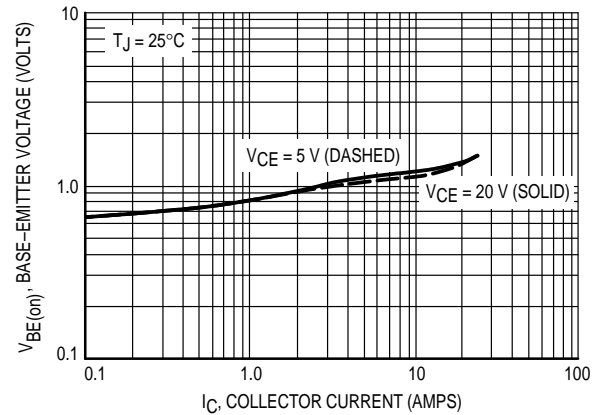

Figure 12. Typical Base-Emitter Voltage

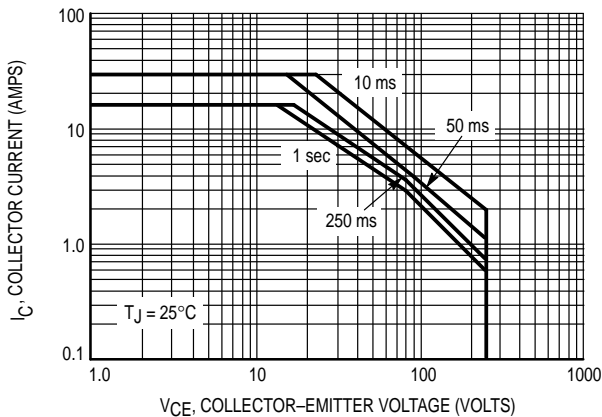

Figure 13. Active Region Safe Operating Area

There are two limitations on the power handling ability of a transistor; average junction temperature and secondary breakdown. Safe operating area curves indicate $I_C - V_{CE}$ limits of the transistor that must be observed for reliable operation; i.e., the transistor must not be subjected to greater dissipation than the curves indicate.

The data of Figure 13 is based on $T_{J(pk)} = 200^\circ\text{C}$; T_C is variable depending on conditions. At high case temperatures, thermal limitations will reduce the power that can be handled to values less than the limitations imposed by second breakdown.

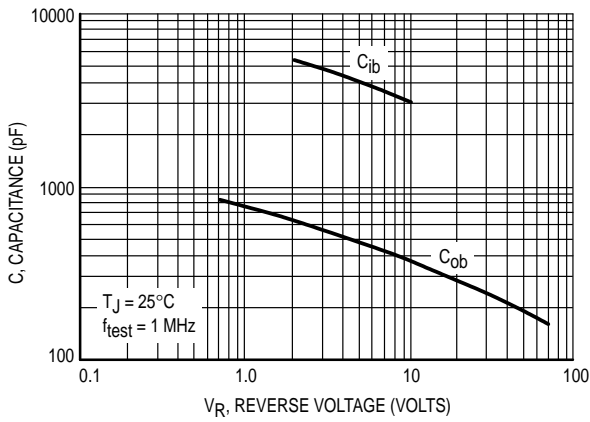

Figure 14. MJ21195 Typical Capacitance

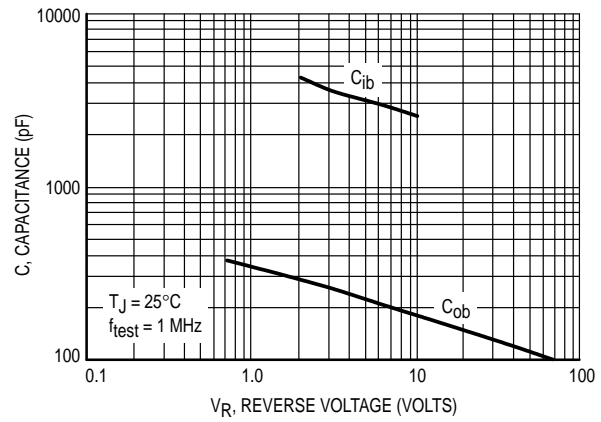

Figure 15. MJ21196 Typical Capacitance

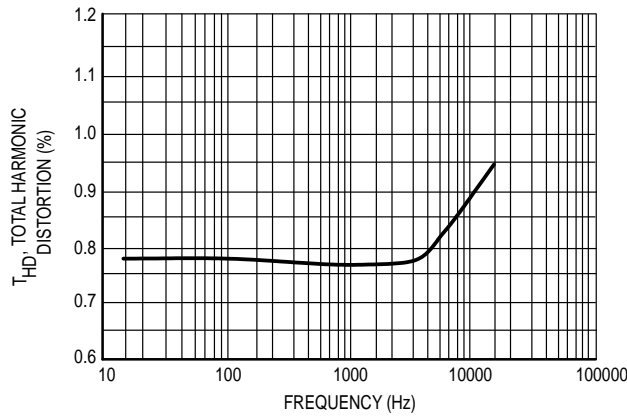

Figure 16. Typical Total Harmonic Distortion

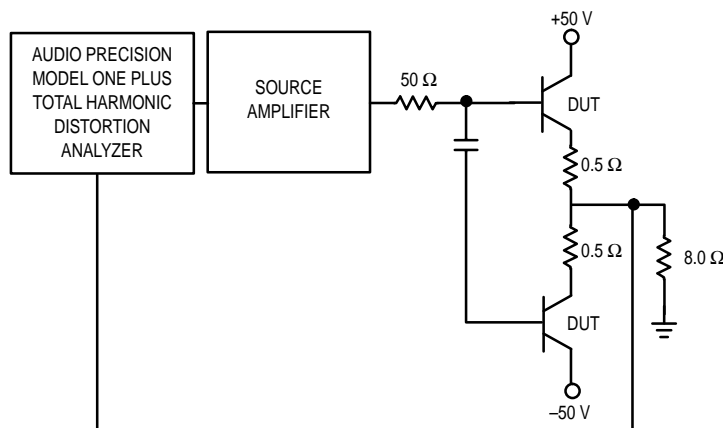

Figure 17. Total Harmonic Distortion Test Circuit