

## Feature

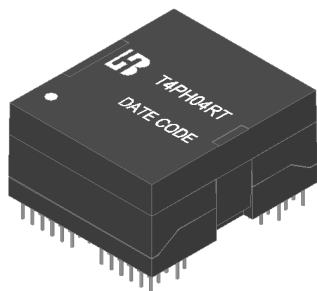

- Complying with IEEE 802.3an standard.
- POE applications with 600mA current capability.
- Complying with ROHS requirements.
- Operating temperature range: -40°C to +90°C
- Storage temperature range: -40°C to +90°C.

### Electrical Specifications @ 25°C

Part Number	Turns Ratio (±5%)		OCL (uH Min) @100KHz/0.1V	L.L (uH Max)	C <sub>w/w</sub> (pF Max)	DCR (Ω Max)	HI-POT
	TX	RX					
T4PH04RT	1CT:1CT	1CT:1CT	100	0.5	28	1.1	AC1500V/1mA

### Continue

Part Number	Insertion Loss (dB Max)			Return Loss (dB Min) @ Load 100Ω		
	1-100 MHz	100-400 MHz	500 MHz	1 ≤ f ≤ 40 MHz	40 < f ≤ 400 MHz	400 < f ≤ 500 MHz
T4PH04RT	-1.0	-1.5	-2.0	-18	- (18-10 log <sub>10</sub> (f/40))	- (8-30 log <sub>10</sub> (f/400))

### Continue

Part Number	Cross talk (dB Min)		DCMR (dB Min)	
	1-100 MHz	100-500 MHz	1-250 MHz	250-500 MHz
T4PH04RT	-40	-30	-30	-22

## Schematic

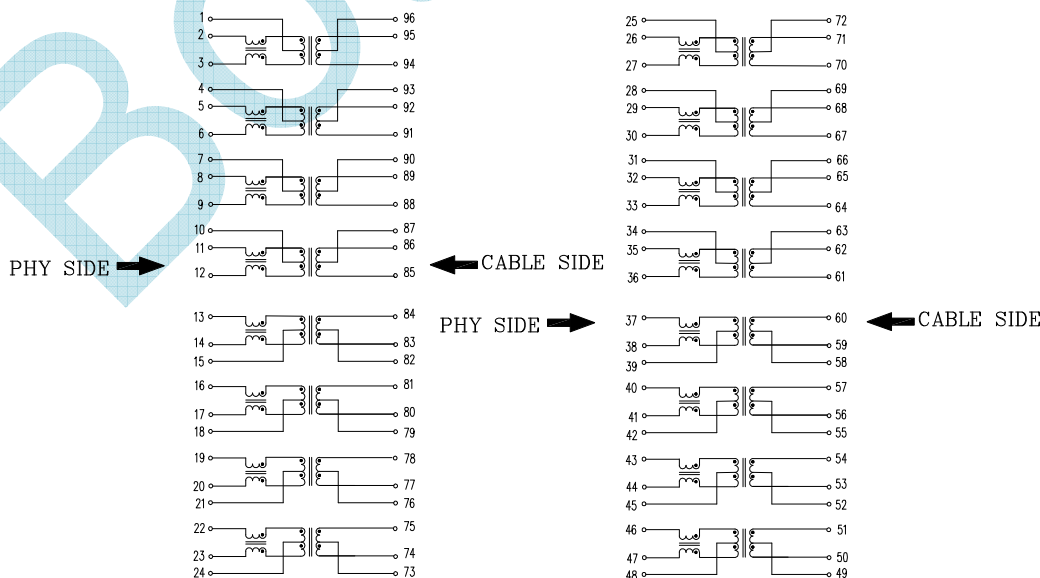

**Mechanical**

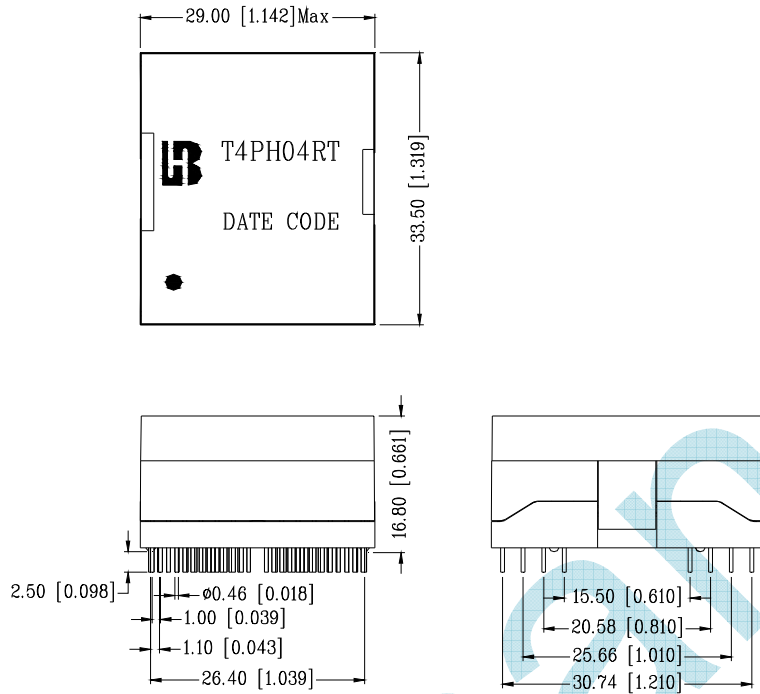

Units: mm [Inches] Tolerance: xx.xx±0.25 [0.010]  
0.xx±0.05 [0.002]

**PCB Layout mounting Hole ( Top View )**

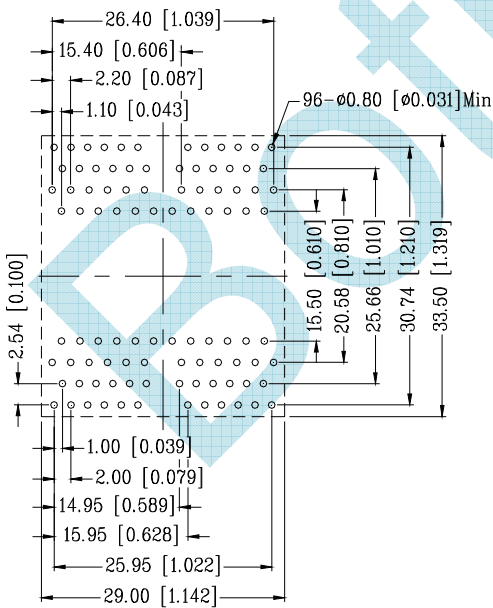

Unless otherwise specified,  
all dimension tolerance are: ±0.08 [±0.003]

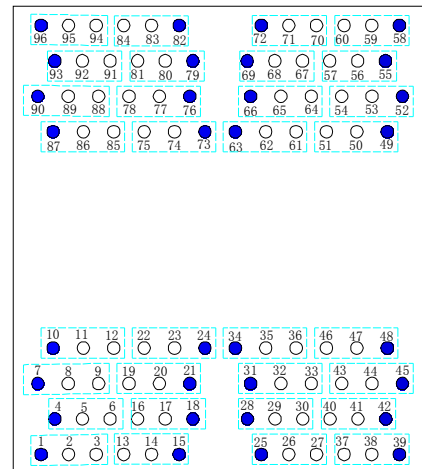

Blue : Center Tap

TUBE PACKAGE

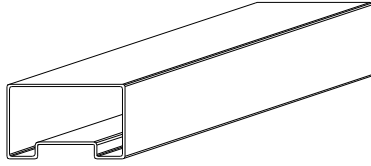

TUBE

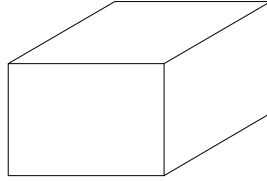

INNER BOX 567x135x125

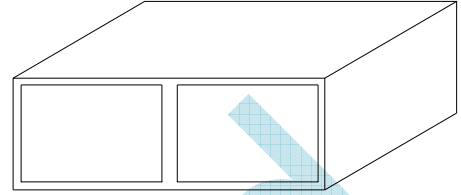

OUTER CARTON 598x287x150

1. 1 TUBE=17PCS
2. 1 INNER BOX=12 TUBES=204PCS
3. 1 OUTER CARTON=2 INNER BOXES=408PCS

Bothhand