



ABS2U THRU ABS10U

SCHOTTKY BRIDGE

1.0A SCHOTTKY BRIDGE RECTIFIER

DESCRIPTION

The UTC **ABS2U THRU ABS10U** is a schottky bridge rectifiers, it uses UTC's advanced technology to provide customers with low forward voltage drop and high current capability, etc.

The UTC **ABS2U THRU ABS10U** is suitable for surface mount application.

FEATURES

- * Low forward voltage drop
- * High current capability
- * High surge current capability
- * Designed for surface mount application

SYMBOL

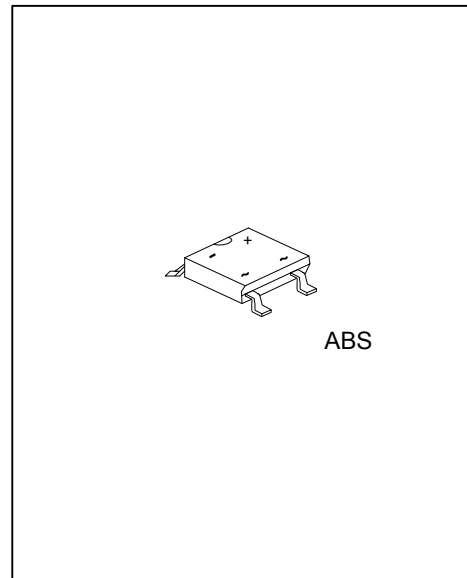
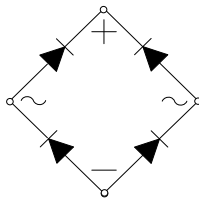

ORDERING INFORMATION

Ordering Number	Package	Packing
ABS2UL-ABS-R	ABS	Tape Reel
ABS4UL-ABS-R	ABS	Tape Reel
ABS6UL-ABS-R	ABS	Tape Reel
ABS8UL-ABS-R	ABS	Tape Reel
ABS10UL-ABS-R	ABS	Tape Reel

<p>ABS2UL-ABS-R</p> <p>(1) Packing Type</p> <p>(2) Package Type</p> <p>(3) Green Package</p>	<p>(1) R: Tape Reel</p> <p>(2) ABS: ABS</p> <p>(3) L: Lead Free</p>
--	---

MARKING

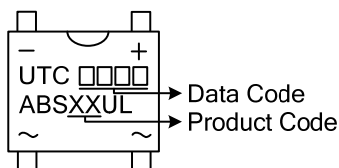

■ ABSOLUTE MAXIMUM RATINGS ($T_A=25^{\circ}\text{C}$, unless otherwise specified)

Single phase, half wave, 60Hz, resistive or inductive load. For capacitance load, derate current by 20%.

PARAMETER	SYMBOL	RATINGS					UNIT
		ABS2U	ABS4U	ABS6U	ABS8U	ABS10U	
Repetitive Peak Reverse Voltage	V_{RRM}	200	400	600	800	1000	V
Working Peak Reverse Voltage	V_{RWM}	200	400	600	800	1000	
DC Blocking Voltage	V_{DC}	200	400	600	800	1000	V
RMS Voltage	V_{RMS}	140	280	420	560	700	V
Average Rectified Output Current $T_A=30^{\circ}\text{C}$	I_O	1.0					A
Non-Repetitive Peak Forward Surge Current, 8.3ms Single Half Sine-Wave Superimposed on Rated Load (JEDEC Method)	I_{FSM}	35					A
Operating Junction Temperature Range	T_J	-55~+150					$^{\circ}\text{C}$
Storage Temperature Range	T_{STG}	-55~+150					$^{\circ}\text{C}$

Notes: 1. Absolute maximum ratings are those values beyond which the device could be permanently damaged.

Absolute maximum ratings are stress ratings only and functional device operation is not implied.

2. Mounted on glass epoxy pc board with 1.3mm^2 solder pad.

3. Mounted on aluminum substrate PC board with 1.3mm^2 solder pad.

■ THERMAL DATA

PARAMETER	SYMBOL	RATINGS	UNIT
Junction to Ambient	θ_{JA}	62.5	$^{\circ}\text{C}/\text{W}$

Note: Measured at 1.0 MHz and applied reverse voltage of 4.0V D.C.

■ ELECTRICAL CHARACTERISTICS ($T_A=25^{\circ}\text{C}$ unless otherwise noted)

PARAMETER	SYMBOL	TEST CONDITIONS	MIN	TYP	MAX	UNIT
Instantaneous Forward Voltage	V_F	$I_F=1.0\text{A}$			1.1	V
DC Reverse Current at Rated DC Blocking Voltage	I_R	$T_J=25^{\circ}\text{C}$			5.0	μA
		$T_J=125^{\circ}\text{C}$			500	μA

■ TYPICAL CHARACTERISTICS

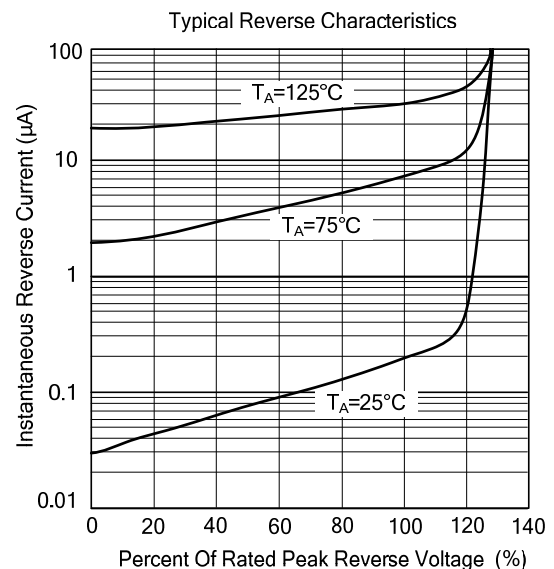
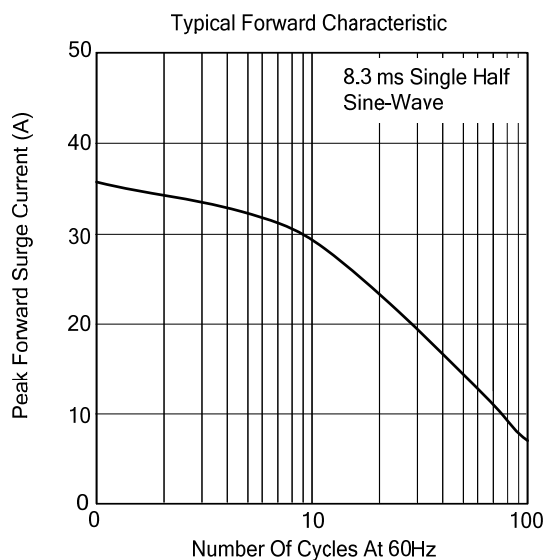
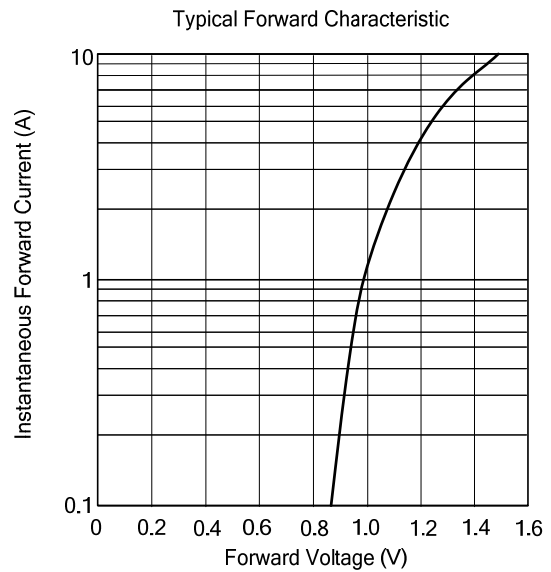
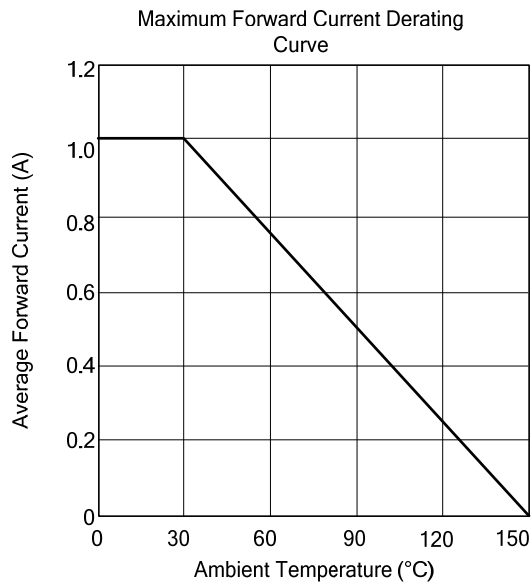

UTC assumes no responsibility for equipment failures that result from using products at values that exceed, even momentarily, rated values (such as maximum ratings, operating condition ranges, or other parameters) listed in products specifications of any and all UTC products described or contained herein. UTC products are not designed for use in life support appliances, devices or systems where malfunction of these products can be reasonably expected to result in personal injury. Reproduction in whole or in part is prohibited without the prior written consent of the copyright owner. The information presented in this document does not form part of any quotation or contract, is believed to be accurate and reliable and may be changed without notice.