

Features

- High collector current
- SOT-23 plastic package
- RoHS compliant

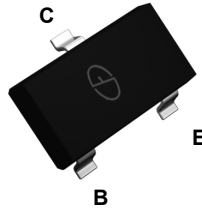

SOT-23

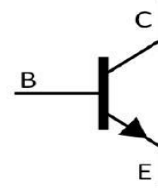

Schematic Diagram

Applications

- Switching application
- General power amplifier

Absolute Maximum Ratings

($T_A=25^{\circ}\text{C}$ unless otherwise specified)

Parameter	Symbol	Rating	Unit
Collector to Base Voltage	V_{CB0}	50	V
Collector to Emitter Voltage	V_{CE0}	45	V
Emitter to Base Voltage	V_{EB0}	5.0	V
Collector Current - Continuous	I_C	500	mA
Collector Current - Peak Collector Current	I_{CM}	1.0	A
Collector Power Dissipation	P_C	250	mW
Junction Temperature	T_J	-55 to +150	$^{\circ}\text{C}$
Storage Temperature Range	T_{STG}	-55 to +150	$^{\circ}\text{C}$

h_{FE} Classifications & Marking

h_{FE} Classifications Symbol	GSBC817-16	GSBC817-25	GSBC817-40
h_{FE} Range	100 to 250	160 to 400	250 to 600
Marking	6A	6B	6C

Electrical Characteristics ($T_A=25^\circ\text{C}$ unless otherwise specified)

Parameter	Symbol	Test Conditions	Min	Typ	Max	Unit
Collector to Base Breakdown Voltage	V_{CBO}	$I_C=10\mu\text{A}$ $I_E=0$	50	-	-	V
Collector to Emitter Breakdown Voltage	V_{CEO}	$I_C=10\text{mA}$ $I_B=0$	45	-	-	V
Emitter to Base Breakdown Voltage	V_{EBO}	$I_E=10\mu\text{A}$ $I_C=0$	5.0	-	-	V
Collector Cut-Off Current	I_{CBO}	$V_{CB}=20\text{V}$ $I_E=0$	-	-	0.1	μA
Emitter Cut-Off Current	I_{EBO}	$V_{EB}=5.0\text{V}$ $I_E=0$	-	-	0.1	μA
DC Current Gain	$h_{FE(1)}$	$V_{CE}=1.0\text{V}$ $I_C=100\text{mA}$	100	-	600	
	$h_{FE(2)}$	$V_{CE}=1.0\text{V}$ $I_C=500\text{mA}$	40	-	-	
Collector to Emitter Saturation Voltage	$V_{CE(sat)}$	$I_C=500\text{mA}$ $I_B=50\text{mA}$	-	-	0.7	V
Base to Emitter Voltage	V_{BE}	$V_{CE}=1.0\text{V}$ $I_C=500\text{mA}$	-	-	1.2	V
Transition Frequency	f_T	$V_{CE}=5.0\text{V}$ $I_C=10\text{mA}$	100	-	-	MHz
Collector Output Capacitance	C_{OB}	$V_{CB}=10\text{V}$ $I_E=0$ $f=1.0\text{MHz}$	-	5.0	-	pF

Typical Characteristic Curves ($T_A=25^\circ\text{C}$ unless otherwise specified)

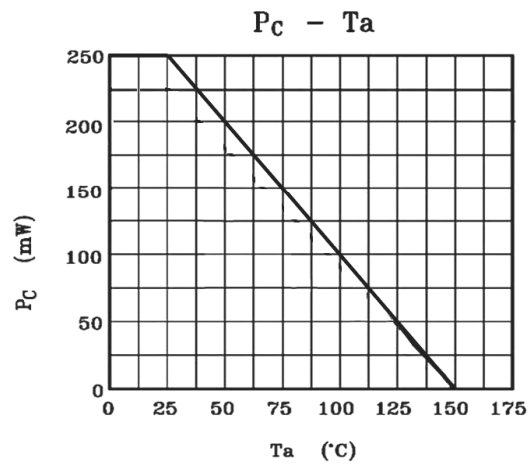
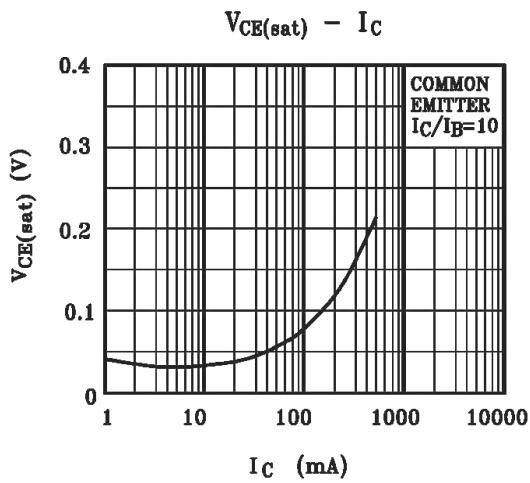
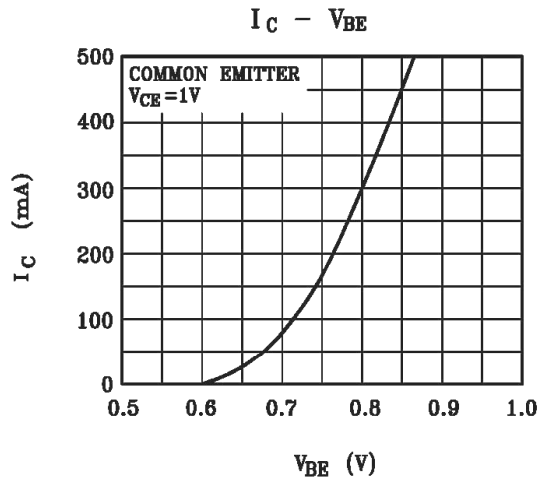
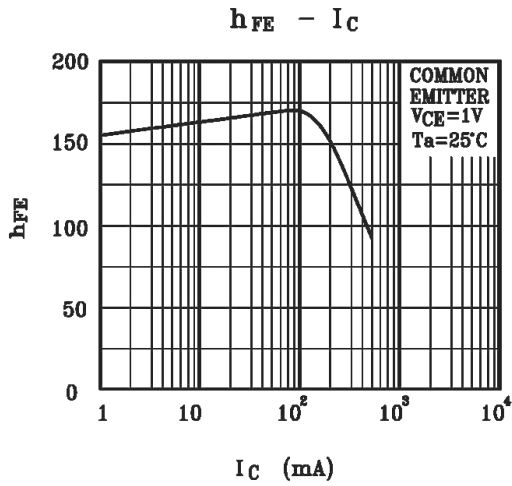

Package Outline Dimensions SOT-23

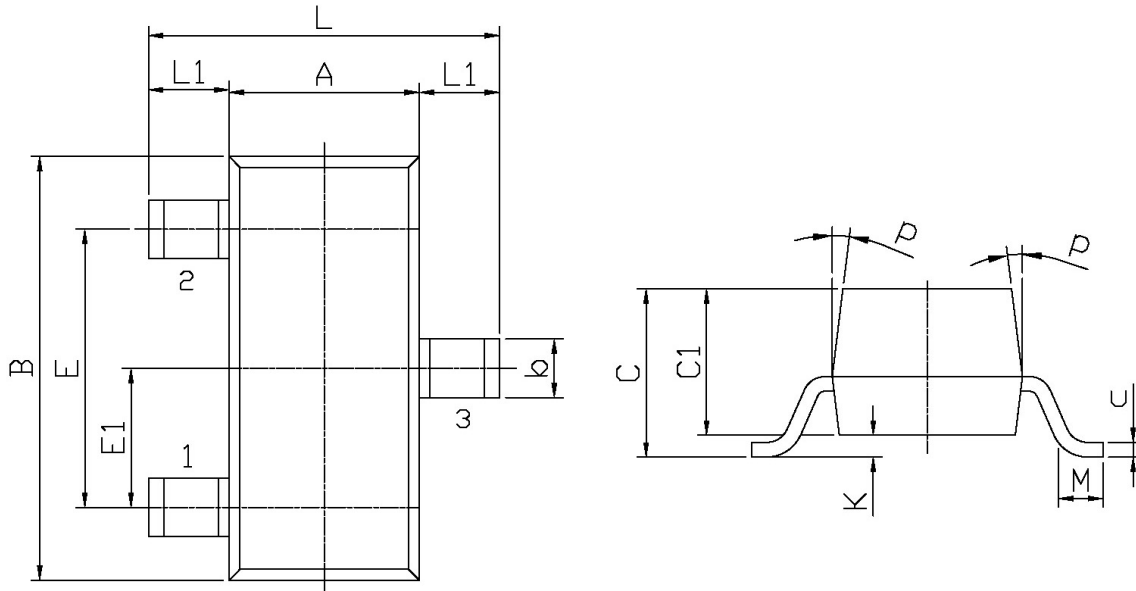

Symbol	Dimensions In Millimeters		Symbol	Dimensions In Millimeters	
	Min	Max		Min	Max
L	2.2	2.7	C	1.30Max	
L1	0.45	0.65	C1	0.90	1.20
A	1.15	1.50	c	0.05	0.20
B	2.70	3.10	K	0	0.10
E	1.70	2.10	M	0.20MIN	
E1	0.85	1.05	P	7°	
b	0.35	0.55			