

OMRON

NEW

Vision sensor with built-in LCD monitor

"Smart Sensor" ZFX-C



*"Essential Innovation
for Future Generations"*

realizing

Easy Vision Being Our Vision

The Omron's new ZFX-C Smart Vision Sensor is a total Image Processing system that includes everything from a camera with an integrated light source to an image-processing unit.

With Omron's newly developed proprietary measurement algorithm, the parameter can be set through only a few steps involving the operation of a touch-panel color monitor.

This "Smart" user interface provides simplicity of usage giving anyone all they can need to perform a complete image enhancement.

The new technology and style of the ZFX-C paves the way to a new era of vision sensors.



“Smart Recipe” with condensed know-how

World's first

Capturing the image processing know-how Omron has accumulated over many years, the world's first “Smart Recipe” has radically reduced setting up time allowing for greater productivity.

One-touch automatic setting

The essential skills for image processing are now packaged into Omron's unique algorithm. The setting that traditionally required much fumbling is now made easy with the “select from auto listed options” using recipes. Lighting setup, the longtime problem for image processing, and the tricky parameter details involved in measurement setup, can now be done automatically with just the flip of a switch.



Smart Recipe

Smart Recipe is an Omron invention of a 3-step setting procedure. By adopting a new algorithm to encapsulate “human know-how”, the auto setup for lighting and measurement is now possible. Anyone can rapidly perform a high level of image processing.

Step 1

Choose best lighting

Patent pending

The know-how and trial and error that have been indispensable and required much time and effort up to now in lighting setup is now an automated process. By just selecting the best one from the candidate images automatically captured by changing the lighting pattern with the auto-lighting, anyone can easily find the optimal lighting. User can now easily determine settings for shiny work with high degrees of reflection and black monochrome work with low degrees of reflection, something very tricky before. In addition, when a more detailed setup is needed, the customized setup can be used to incorporate know-how.

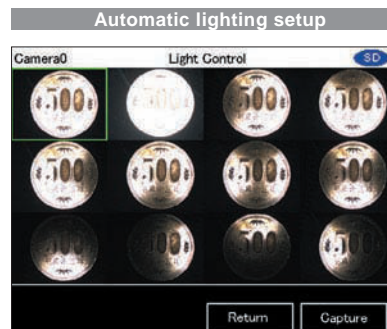

With automatic lighting setup, user can simply select the best image from thumbnail of candidate images.

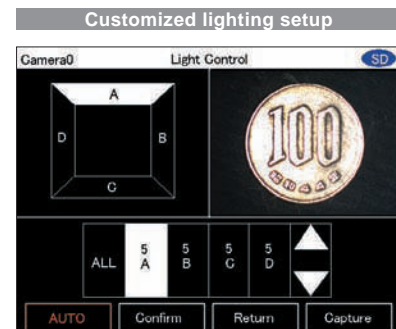

A more detailed set up is possible with the customized lighting setup while looking at the image.

Built-in lighting camera that enables an advanced automatic lighting



The Built-in lighting camera and improved controller brings about an even higher degree of automatic lighting. With this camera you can produce up to a maximum of 1296 patterns of reflective lighting making the chore of choosing lighting equipment unnecessary. The lighting setup can be managed as digital data so it is possible to store the optimal setup for each job, and it smoothly handles the changing of settings. It is also possible to fine-tune the customized setup can be added.



Step2 Choose measurement icon

The measurement method can be specified by just choosing the icon from out of a total of 9 measurement items for different types of inspection.

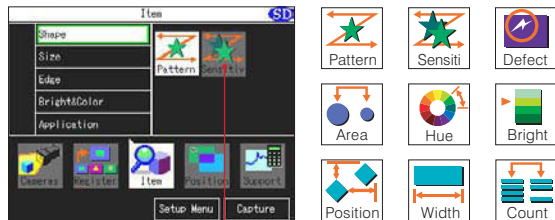

Basic operations merely through selection of on-screen icons
Intuitive operations

Step3 Draw region, press and go

Just specify the region of interest and press Auto key and the system will determine the most suitable parameters for the target image.

Now anyone can easily perform a complex and advanced parameter setting which used to require special knowledge and cumbersome steps.

Customized setting is also possible by fine tuning the parameters automatically set up. The time required to set up parameters can be significantly reduced.

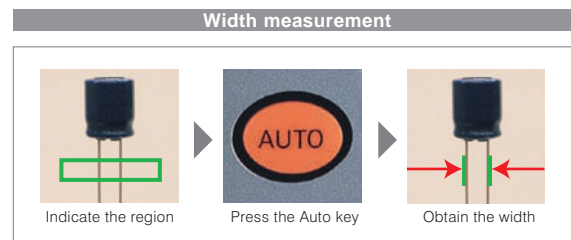

Appropriate filters and edge scan directions for width measurement can be automatically set by analyzing the target image.

Easily adjusts position

3-step position correction

Even when the position of work changes due to the conveyor condition, the excellent position correction function can come into play allowing adjustment using the work contours, two stage position correction and so on. With the auto setup, position difference can be easily adjusted to enable stable measurement.

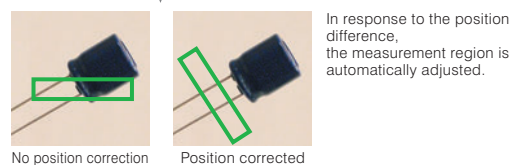
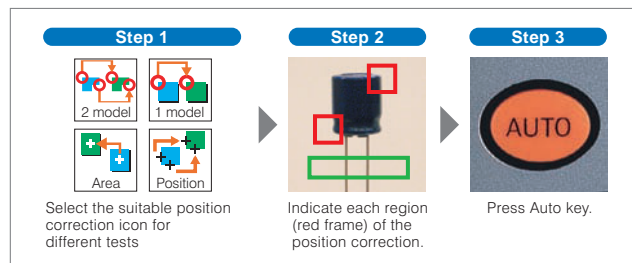

Tailored Measurement item

Including two shape measurement items, the system contains 5 categories and 9 types of Shape, Size, Edge, Bright and Hue, Application measurement items. It responds to the variety of inspection requirements in the manufacturing sites.

Shape measurement item

Pattern search

Fastest in the industry

The shape measurement is a fundamental algorithm for image processing. By adopting a new image processor, the pattern search achieves a balance in the three factors of speed, precision and stabilization, something that was an arduous task until now. It now supports a 360-degree revolving search and a sub-pixel processing of 1000 to 1 pixel units as well as a multi area searcher. The robust pattern search can respond to the multitude of inspects and measurements of any application.

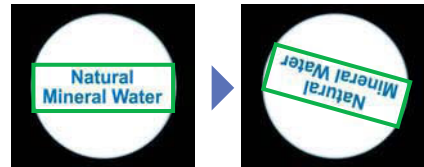

A further improvement is the balance achieved in revolving searches that occur in pattern matching for a revolving work. The most time-consuming 360-degree revolving search can be performed with an excellent accuracy.

Sensitive search

NEW

When it comes to the difficult processing of detecting small differences, the Omron's unique sensitive search matches work at a smallest detail and in doing so makes such detection all the more possible. It resists variations in position and density to capture even the smallest detail in the complex patterns.



It is possible to detect even the smallest differences in the work.

Application specific measurement item

Defect

It is used to detect smears, scratches, chipping and burrs on the work. Defects are displayed on the screen, which makes it ideal tool for visual inspection.



Almost indistinguishable scratches can be detected after enhancing contrast using the color filter.

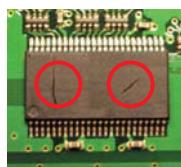

Counts the number of scratches

Size measurement item

Region

Detects the existence of work within a region and measures its size based on the area to perform various classification.



LED illumination is determined based on the area of extracted color.



Smart sensor
ZFX-C

Bright and Hue measurement item

Hue

NEW

The three factors in color, i.e. hue, saturation and brightness value, are measured and digitalized. And whilst an accurate differentiation of the color is performed, it is also possible to measure the color variety with the deviation measurement function (with color camera connected).



The individual threshold for the hue, saturation and brightness value parameters can be set up so that even if one of them is different, it can be detected accurately and intensely. On the other hand, by expanding the range for the brightness value and saturation, and so on, it is possible to stabilize the color detection in the hue without any interference from illumination alterations.

Bright

Measures the brightness within a region. It can be used for checking the presence of a component, etc., by generating average density and density deviation values.

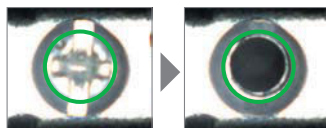

Based on the change in brightness, the presence of a screw (OK or NG) is determined.

Functions to support optimal measurements

Up to 32 regions

In one captured image, it is possible to measure a multiple up to 32 regions. When carrying out difficult inspection, it is possible to set-up a color filter and color extraction for each measurement item.



Measures three regions.

Screen registration function

It is possible to register the image used in the setup. When you use the live image during setup sometimes the set up is not correct due to position differences in the work. However, with the registered image saved in the SD memory card as a "master image for setup", it can be easily verified when abnormal measurements occur.

Edge measurement item

Position

The existence or not and the position of the edge is measured. Oblique edges can now be measured even in complex conditions and even more accurate position measurements can be taken. The peak bottom measurement function that can accurately capture the edges is now supported.

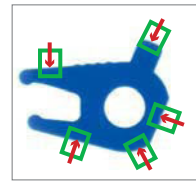

Width

The width of the edge is measured. By using the edge partitioning method, it is possible to measure the maximum and minimum width.

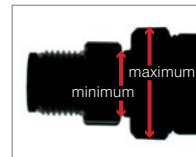

Count

The number of edges inside the area is counted. Based on the number of edges on the pre-registered good model, it counts the edges in the area and determines the correctness.



Gray filtering setup using double screen

For each measurement item, it is possible to run 8 types of gray filtering such as expansion and contraction to enable stable measurements. Through the "setup while looking" option that makes it possible to check the preview, the optimal gray filtering can be selected.



Calculations function

It is possible to make arithmetical calculations for measurement values, and calculations involving general functions, trigonometry, geometrical functions and logical functions. It is possible to setup internal variables, and complex calculations can be carried out.

Visualized Controller

Smallest in class controller build in embedded LCD saves space and time.



Visualized setting and monitoring

Smallest in class

Despite its small form factor, the enlarged screen significantly improves the visibility and the ease of operation. The method of operation can be selected from 3way - the touch pen, key pad or console.



Enlarged screen enables wide range of views



Simple setting with large screen

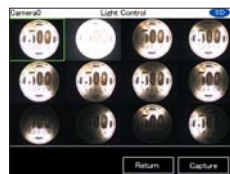

Overview with thumbnail screen

Rich interface support

Automatically detects the connected camera and displays the appropriate menu. With rich selection of interface including parallel RS-232C/RS-422, USB 2.0, the extensibility is superior.

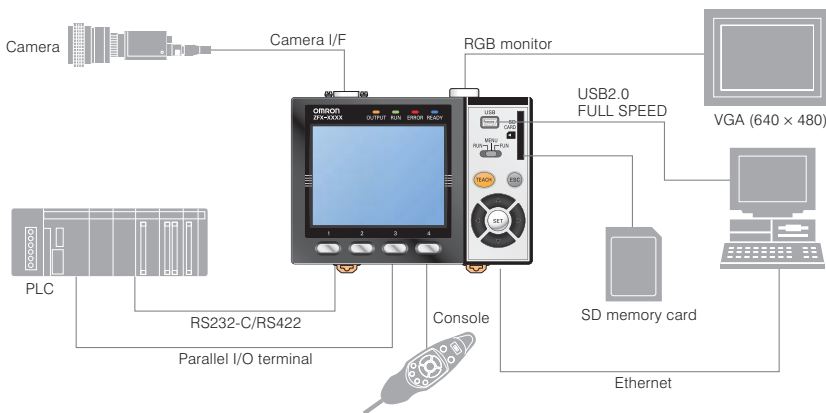



Intensive camera solutions

8 types of cameras that can be selected for different types of work to achieve optimal measurement.

Built-in lighting camera

Triple-speed camera (IP65)

Line up of 6 types of built-in lighting cameras that do not need lighting selection or setup. The color camera can respond to a wide range of work with a 5-150mm field of view. Through image compression and partial capturing, it can support a high-speed line.



ZFX-SR10 (monochrome)
Field of view 5 ▶ 9 mm



ZFX-SC50 (color)
Field of view 10 ▶ 50 mm
(IP67 model available)



ZFX-SR50 (monochrome)
Field of view 10 ▶ 50 mm



ZFX-SC90 (color)
Field of view 50 ▶ 90 mm
(IP67 model available)



ZFX-SC10 (color)
Field of view 5 ▶ 9 mm

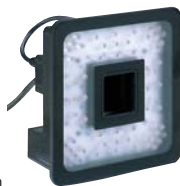

ZFX-SC150 (color)
Field of view 80 ▶ 150 mm
(IP67 model available)

C-mount camera unit

NEW

Triple-speed camera

This product line includes C-mount camera that can select the lens to match the field. It can be used in combination with optional lighting such as transmitted lighting, low angle lighting and bar lighting, etc. to support different inspection types.



ZFX-SC
(color)



ZFX-S
(monochrome)

Innovative triple-speed camera

Fastest in the industry

Performs fast transfer of 11.1ms that are 3 times faster than standard cameras and 1.5 times faster than high-speed cameras while maintaining a resolution of the whole screen. In addition, a super speed, minimum 3.2ms transfer is possible with image compressions and partial capturing.

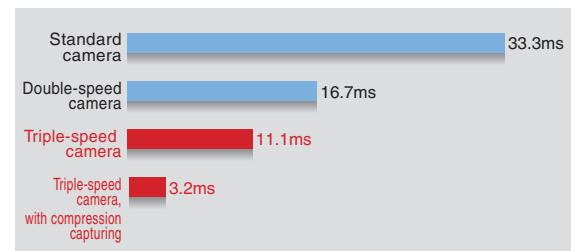

Excellent ease of use

Flexible installation

Flexible installation supported for different mounting site conditions. It can be mounted on DIN rail as well as on the control panel surface. (Optional panel mount adapter available.)

Hybrid interface

A new interface that supports both parallel I/O and terminal platform to dramatically improve the ease of wiring.



advanced Color Engine

The ZFX-C's advanced auto-color processing ability makes stable and accurate measurements a reality, even for usually difficult to detect contrast and low lighting work.



Automatic color filter

Industry's first

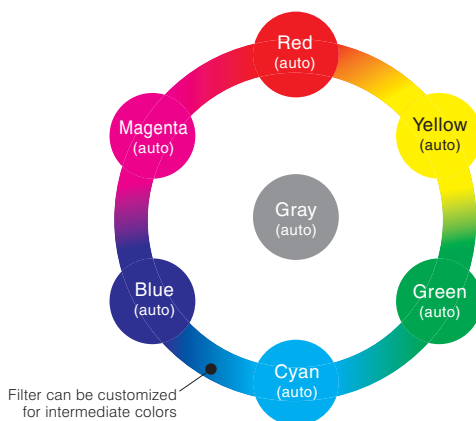

Even for images clearly distinguishable in color, when converted to monochrome the contrast tends to become low. Color filter analyzer automatically selects the optimal color filter (auto color filter) based on the image analysis result to adjust the contrast, to allow for stable image measurement. Any intermediate color can be arranged for the color filter using custom settings.

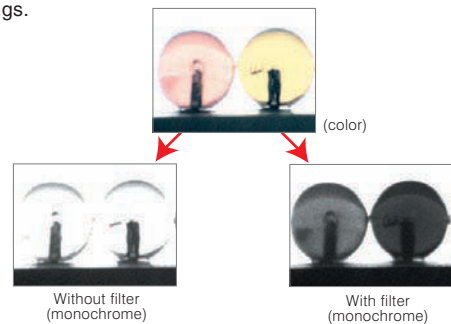

Choose desired color

NEW

Simply select from the list of colors

It is now possible to run an automatic pickup of color, something that used to be a complex procedure, using simply the Auto key. The advanced color engine automatically detects the color distribution in the selected range and automatically lists up to 4 optional color pickup in the order of color area. After that, user can simply select the desired color to be pickup.



Specify the pickup area and press the Auto key to display 4 optional colors for pickup.

Fine-tuning by using dual-screen

The auto color pickup can fine-tune each of the hue, saturation and brightness value. Using double screens, the source image and the color pickup image can be compared and adjusted. This enables easy and stable pickup of colors with low illumination (traditionally difficult to pickup) and colors with large variation. The efficiency of operation is greatly increased.

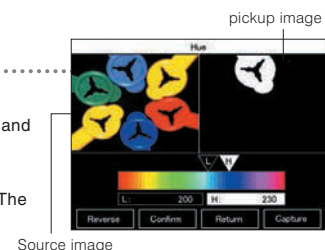

Versatile support tool

The concept behind Smart Recipe that eradicates the pain of image processing has been leveraged in the system ramp-up and deployment.

Image storing and re-measurement

Stores up to 100 files of image data in the main memory without slowing measurement speed. Images data can be re-measured so even with a high-speed line, for example, the results of the measurements can be checked at leisure afterwards.



On-site fine adjustment

NEW

On site variety adjustment of work is essential. Without returning to the menu mode, the measurement region, color contrast setup and so on can be tuned in adjust mode, using double screen to compare with the original image. The measurement results of the stored images can also be displayed so the unnecessary rejects can be efficiently reduced.

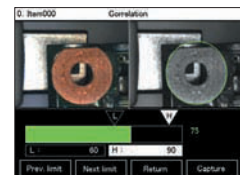

Variety adjustment can be controlled simply using the adjust mode.

Visualized monitoring and analysis

NEW

Through a list/individual view of measurement results, and a logging monitor display, user can easily understand the measurement situation. The results display can be chosen from 9 patterns including individual results view (upper left, upper middle), lists of results/region view (lower left, lower middle), list of results/All results view (upper right), and data list view (bottom right). The results can be reviewed in detail which is useful for statistical analysis.

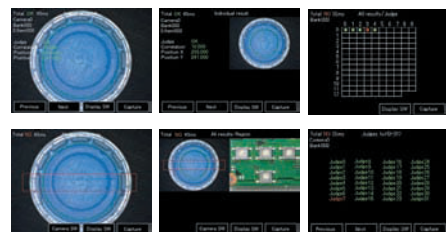

Password function



It is possible to set up a password that alters between operating mode and other. This protects against operational errors at the manufacturing site.

Display capture function

Display images can be captured and stored in the SD memory card. Useful for report documentation.

Ordering Information

Controllers

Appearance	Power supply	Circuit type	Model
1-camera model 	DC21.6 to 26.4V	NPN	ZFX-C10
		PNP	ZFX-C15
2-camera model 		NPN	ZFX-C20
		PNP	ZFX-C25

Cameras

Appearance	Type	Setting distance	Sensing area	Model	Remarks	
 (ZFX-SC50)	Camera with lighting	Monochrome type	34mm to 49mm	4.9mm x 4.9mm to 8.9mm x 8.9mm(variable)	ZFX-SR10 ZFX-SR10R (See note.)	Cable length:2m
			38mm to 194mm	9.8mm x 9.8mm to 49mm x 49mm(variable)	ZFX-SR50 ZFX-SR50R (See note.)	
		Color type	34mm to 49mm	4.9mm x 4.9mm to 8.9mm x 8.9mm(variable)	ZFX-SC10 ZFX-SC10R (See note.)	
			31mm to 187mm	9.8mm x 9.8mm to 49mm x 49mm(variable)	ZFX-SC50 ZFX-SC50W(IP67) ZFX-SC50R (See note.)	
			67mm to 142mm	49mm x 49mm to 89mm x 89mm(variable)	ZFX-SC90 ZFX-SC90W(IP67) ZFX-SC90R (See note.)	
			115mm to 227mm	89mm x 89mm to 148mm x 148mm(variable)	ZFX-SC150 ZFX-SC150W(IP67) ZFX-SC150R (See note.)	
	Camera only	Monochrome type	The CCTV lens is selected according to the range of detection and the installation distance.	ZFX-S	A Camera Cable is required.	
		Color type		ZFX-SC		

Note. Equipped with a robot cable.

Camera Cables

Type		Cable length	Model
Camera Cable (See note 1.)	Normal type	3m,8m	ZFX-VS
	Robot cable type	3m	ZFX-VSR
Right-angle Camera Cable (See note 2.)	Normal type (bending direction: A)	3m,8m	ZFX-VSLA 3M/8M
	Robot cable type (bending direction: A)	3m	ZFX-VSRLA 3M
	Normal type (bending direction: B)	3m,8m	ZFX-VSLB 3M/8M
	Robot cable type (bending direction: B)	3m	ZFX-VSRLB 3M

Note 1: It is necessary for ZFX-S and ZFX-SC. ZFX-SR_/SC_ is a cable drawing out type, it doesn't use it.

Note 2: Cable Bending Directions

Bending Direction A
(Model numbers ending in "A")

The Cable bends downward at the Camera.

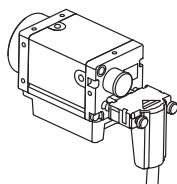

The Cable bends toward the front panel at the Controller.

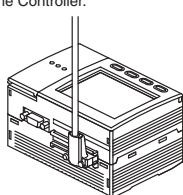

Bending Direction B
(Model numbers ending in "B")

The Cable bends upward at the Camera.

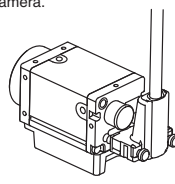

The Cable bends toward the back panel at the Controller.

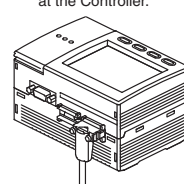

Camera extension cable

Type		Cable length	Model
Camera Extension Cable	Normal type	3m	ZFX-XC3A (See note.1)
		8m	ZFX-XC8A (See note.1)
	Robot cable type	3m	ZFX-XC3AR (See note.1)
Camera Extension Cable (long-distance type)	Extension cable (See note 2.)	15m,25m	ZFX-XC_BR
	Digital equalizer (camera side)	0.2m	ZFX-XEQ01
	Digital equalizer (Controller side)	0.2m	ZFX-XEQ02

Note: The total combined length of the cables connected to the Controller and camera must not exceed 28.4 m (including the camera cable).

Note 1: Up to two camera extension cables can be connected to the camera cable as long as the total cable length between the controller and the camera does not exceed 19 m.

Note 2: Connect the ZFX-VS□□/VSR□□ Camera Cable to the Camera and connect the ZFX-XC□A/XC□AR Extension Cable to the Controller.

Other cable

Type	Cable length	Model
Parallel I/O Cable	2m,5m	ZFX-VP
RS-232C Cable	2m	ZFX-XPT2A
	5m	ZFX-XPT5A
	15m	ZFX-XPT15A
RS-422 Cable	2m	ZFX-XPT2B
	5m	ZFX-XPT5B
	15 m	ZFX-XPT15B
Monitor Cable	2m,5m	FZ-VM
Special USB cable	1.8 m	ZFX-XUSB

Accessories

Type	Model	
Console	ZFX-KP (2m / 5m)	
LCD Monitor	FZ-M08	
Panel Mount Adapters	ZFX-XPM	
Optional Lighting (See note 1.)	bar lighting	ZFV-LTL01
	bar double-lighting	ZFV-LTL02
	bar low-angle lighting	ZFV-LTL04
	light source for through beam	ZFV-LTF01
CCTV Lenses /Extension Tubes	3Z4S-LE series	
External Lighting	FLV series	

Note 1: It is possible to ZFX-SC50 and ZFX-SC90 use it.

Specifications

Controllers

Item		ZFX-C20	ZFX-C25	ZFX-C10H	ZFX-C15H	ZFX-C10	ZFX-C15
Number of connected cameras		2		1			
Connectable camera		ZFX-SR_/SC_/S/SC					
Processing resolution		When ZFX-SR_/SC_ is connected:464 (H) x464 (V) When ZFX-S/SC is connected:608 (H) x464 (V)					
Display	LCD monitor	3.5" TFT color LCD (320 x 240 pixels)					
	Indicator	"Measuring" indicator (color: green): RUN Trigger indicator (color: blue): ENABLE Judgment indicator (color: orange): OUTPUT Error indicator (color: red): ERROR					
External I/F	Parallel interface	Input	12 points (RESET, DSA, DI0 to 8, TRIG)				
		Output	23 points (OR, ERROR, RUN, ENABLE, GATE, STGOUT0 to 1 (*1), DO0 to 15)				
		Circuit type	NPN	PNP	NPN	PNP	NPN
	Serial interface	USB2.0	1 port, FULL SPEED, MINI-B connector				
		RS-232C	1 port, max. 115200 bps (cannot be used simultaneously with RS-422 interface)				
		RS-422	1 port, max. 115200 bps (cannot be used simultaneously with RS-232C interface)				
	Network communications	Ethernet	1 port, 100BASE-TX/10BASE-T				
	Monitor output	Analog RGB output, 1 ch (resolution VGA: 640 x 480)					
Memory card I/F	SD card slot 1 ch						
Operation I/F		Touch panel, key operation, console connection					
Main functions	Number of registered banks		32 banks				
	Number of setup items		128 items/1 bank			32 items/1 bank	
	Measurement items	Shape inspection	Pattern search, sensitive search, flexible search, grappic search			Pattern search, sensitive search	
		Size inspection	Area, labeling			Area	
		Edge inspection	Position, width, count, angle			Position, width, count, angle	
		Brightness/color inspection	Brightness, HUE			Brightness, HUE	
		Application-based inspection	Defects, grouping			Defects	
Position correction		1 model search, 2 model search, position, area, labeling, angle			1 model search, 2 model search, position, area, angle		
Additional functions	Image memory function		Max. 100 images (when 2 cameras are connected, 50 images/camera)				
	Analysis function		Logging monitor			---	
Menu language		Japanese/English (can be switched)					
Ratings	Power supply voltage		21.6 to 26.4 VDC (including ripple)				
	Current consumption		1.5 A max.		1.2 A max.		1.0 A max.
	Insulation resistance		Across all lead wires and controller case: 20 MΩ (by 250 V megger)				
	Dielectric strength		Across all lead wires and controller case, 1000 VAC, 50/60 Hz, 1 min				
Operation environment robustness	Ambient temperature range		Operating: 0 to + 50 C, Storage: -15 to +60 C (with no icing or condensation)				
	Ambient humidity range		Operating and storage: 35% to 85% (with no condensation)				
	Ambient atmosphere		No corrosive gases allowed				
	Degree of protection		IP20 (IEC60529)				
	Vibration resistance (durability)		Vibration frequency: 10 to 150 Hz Single-amplitude: in0.35 mm Acceleration: 50 m/s ² 10 times for 8 minutes in X, Y, and Z directions				
	Shock resistance (destructive)		150 m/s ² 3 times each in 6 directions (up/down, left/right, forward/backward)				
Material		Case: Polycarbonate (PC), Plate face: PMMA					
Weight		Approx. 650 g				Approx. 620 g	
Accessories		Touch pen (ZFX-TP), Exhaust unit (ZFX-EU), Terminal block adapter (ZFX-XTB) Terminal block adapter mounting screws (4 p'ces) , Ferrite core (2 p'ces), Instruction Sheet, and Power connector					

*1 Only STGOUT0 is functional on the ZFX-C10H/C15H/C10/C15.

Specifications

Cameras

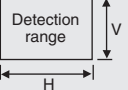
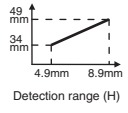
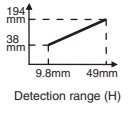
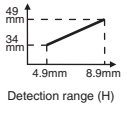
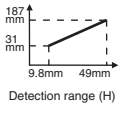
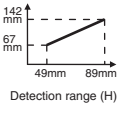
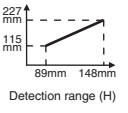
Item	ZFX-SR10 /SR10R	ZFX-SR50 /SR50R	ZFX-SC10 /SC10R	ZFX-SC50 /SC50W /SC50R	ZFX-SC90 /SC90W /SC90R	ZFX-SC150 /SC150W /SC150R	
Detection range (H x V) 	4.9 mm x 4.9 mm to 8.9 mm x 8.9 mm (variable)	9.8 mm x 9.8 mm to 49 mm x 49 mm (variable)	4.9 mm x 4.9 mm to 8.9 mm x 8.9 mm (variable)	9.8 mm x 9.8 mm to 49 mm x 49 mm (variable)	49 mm x 49 mm to 89 mm x 89 mm (variable)	89 mm x 89 mm to 148 mm x 148 mm (variable)	
Setting distance (L)	34 mm to 49 mm	38 mm to 194 mm	34 mm to 49 mm	31 mm to 187 mm	67 mm to 142 mm	115 mm to 227 mm	
Relationship between setting distance and detection range							
Image capture element	All-pixel capture inter-line transfer type 1/3" CCD (monochrome)		All-pixel capture inter-line transfer type 1/3" CCD (color)				
Effective number of pixels	659(H) x 494 (V)						
Pixel size	7.4 μm (H) x 7.4 μm (V)						
Shutter speed	1/170s to 1/20000s						
Partial function (partial capture)	OFF		1/2 partial, 1/4 partial				
Image rate function	Fine, Normal, High speed		Not available				
Frame rate (at capture of entire screen)	90 fps						
Lens mount	— (with Lens)						
Lighting	Lighting method	Pulse lighting					
	LED	Red LED		White LED			
	Type	Direct lighting					
	Guide light	Available (center, measurement region)		Not available			
	Optional lighting I/F	Not available		Available (ZFV-LT Series)		Not available	
Indicator Class	Risk Group 1 (IEC62471-2)						
Ratings	Power supply voltage (supplied from Controller)	15 VDC		15 VDC, 48 VDC			
	Current consumption	Approx. 200 mA		Approx. 350 mA (15 VDC: approx. 150 mA, 48 VDC: approx. 200 mA) (including current consumption when optional lighting is connected)			
Operation environment robustness	Ambient temperature range	Operating: 0 to + 40 C, Storage: -20 to +65 C (with no icing or condensation)					
	Ambient humidity range	Operating and storage: 35% to 85% (with no condensation)					
	Ambient atmosphere	No corrosive gases allowed					
	Degree of protection	IP65 (IEC60529)		ZFX-SC___: IP65 (IEC60529), ZFX-SC___W: IP67 (IEC60529)			
	Dielectric strength	1000 VAC 50 Hz/60 Hz 1 min					
	Vibration resistance (durability)	10 to 150 Hz Single-amplitude 0.35 mm 10 times for 8 min each in X, Y, and Z directions					
Shock resistance (destructive)	150 m/s ² 3 times each in 6 directions (up/down, left/right, forward/backward)						
Connection method	Cable built-in type (cable length: 2 m)						
Cable type	ZFX-SC□□□/SC□□□W/SR□□: Normal cable ZFX-SC□□□R/SR□□R: Robot cable						
Material	ZFX-SR10/SR50/SC10/SC50/SC50W/SC90/SC90W/SC150/SC150W/SC150R: Case: ABS, mounting fixture: PBT ZFX-SR10R/SR50R/SC10R/SC50R/SC90R: Case: ABS, Mounting fixture (base): Aluminum, Mounting fixture (bracket): Stainless steel						
Weight	ZFX-SR10/SR50/SC10: Approx. 200 g (including mounting fixture and cable) ZFX-SR10R/SR50R/SC10R: Approx. 270 g (including mounting fixture and cable) ZFX-SC50/SC50W: Approx. 270 g (including mounting fixture and cable) ZFX-SR50R: Approx. 400 g (including mounting fixture and cable)				ZFX-SC90/SC90W: Approx. 300 g (including mounting fixture and cable) ZFX-SC90R: Approx. 400 g (including mounting fixture and cable)		Approx. 600 g (including mounting fixture and cable)
Accessories	ZFX-SR10/SR50/SC10: Mounting fixture (ZFV-XMF) 1 p'ce, Ferrite core 2 p'ces, Instruction Sheet ZFX-SR10R/SR50R/SC10R: Mounting fixture (ZFV-XMF3) 1 set, Ferrite core 2 p'ces, Instruction Sheet			ZFX-SC50/SC50W/SC90/SC90W: Mounting fixture (ZFV-XMF2) 1 p'ce, Ferrite core 2 p'ces, Instruction Sheet ZFX-SC50R/90R: Mounting fixture (ZFV-XMF4) 1 set, Ferrite core 2 p'ces, Instruction Sheet		Ferrite core 2 p'ces, Instruction Sheet	

Specifications

Cameras

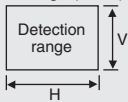
Item	ZFX-S (monochrome type)	ZFX-SC (color type)
Detection range (H x V)	 <p>The CCTV lens is selected according to the detection range and the setting distance.</p>	
Setting distance (L)		
Relationship between setting distance and detection range		
Image capture element	All-pixel capture inter-line transfer type 1/3" CCD (monochrome)	All-pixel capture inter-line transfer type 1/3" CCD (color)
Effective number of pixels	659(H) x 494 (V)	
Pixel size	7.4 μm (H) x 7.4 μm (V)	
Shutter speed	1/170s to 1/20000s	
Partial function (partial capture)	Not available	1/2 partial, 1/4 partial
Image rate function	Fine, Normal, High speed	Not available
Frame rate (at capture of entire screen)	90 fps	
Lens mount	C mount	
Lighting	Lighting method	—
	LED	
	Type	
	Guide light	
Optional lighting I/F	Not available	
Ratings	Power supply voltage (supplied from Controller)	15 VDC, 48 VDC
	Current consumption	Approx. 160 mA
Operation environment robustness	Ambient temperature range	Operating: 0 to + 50°C, Storage: -25 to +65°C (with no icing or condensation)
	Ambient humidity range	Operating and storage: 35% to 85% (with no condensation)
	Ambient atmosphere	No corrosive gases allowed
	Degree of protection	IP20 (IEC60529)
	Dielectric strength	500VAC 50 Hz/60Hz 1 min
	Vibration resistance (durability)	10 to 150 Hz Single-amplitude 0.35 mm 10 times for 8 min each in X, Y, and Z directions
Shock resistance (destructive)	150 m/s ² 3 times each in 6 directions (up/down, left/right, forward/backward)	
Connection method	Connector connection type (camera cable ZFX-VS/VSR required)	
Cable type	ZFX-SC□□□□/SC□□□□W/SR□□□□: Normal cable ZFX-SC□□□□R/SR□□□□R: Robot cable	
Material	Case: Aluminum die-cast, Cover: Zinc-plated copper plate 0.5 mm thick, Camera mounting base:ABS	
Weight	Approx. 80 g	
Accessories	Instruction Sheet	

■ CCTV Lenses

■ Optical Graph

If using the ZFX-S/SC Camera (Camera only), refer to the optical graph below and select the lens and Extension Tubes. The lens to be selected will depend on the size of the measurement object and the camera distance.

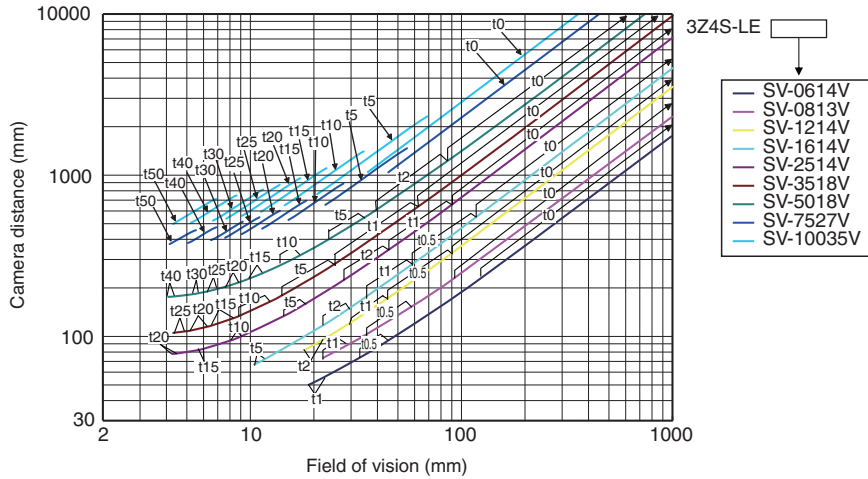





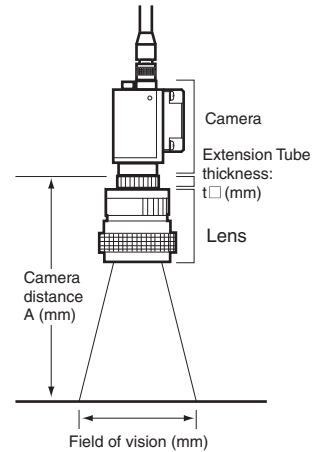



■ Meaning of Optical Graph

The X axis of the graph shows the field of vision L (mm), and the Y axis shows the camera distance A (mm).



■ CCTV Lenses

Lens model	3Z4S-LE SV-0614V	3Z4S-LE SV-0813V	3Z4S-LE SV-1214V	3Z4S-LE SV-1614V	3Z4S-LE SV-2514V	3Z4S-LE SV-3518V	3Z4S-LE SV-5018V	3Z4S-LE SV-7527V	3Z4S-LE SV-10035V
Appearance	 29 dia. 30.0	 28 dia. 34.0	 29 dia. 29.5	 29 dia. 24.0	 29 dia. 24.5	 29 dia. 33.5	 32 dia. 37.0	 32 dia. 42.0	 32 dia. 43.9
Focal length	6 mm	8 mm	12 mm	16 mm	25 mm	35 mm	50 mm	75 mm	100 mm
Brightness	F1.4	F1.3	F1.4	F1.4	F1.4	F1.8	F1.8	F2.7	F3.5
Filter size	M27 P0.5	M25.5 P0.5	M27 P0.5	M27 P0.5	M27 P0.5	M27 P0.5	M30.5 P0.5	M30.5 P0.5	M30.5 P0.5

■ Extension Tubes

Model	3Z4S-LE SV-EXR
Contents	Set of seven tubes (0.5 mm, 1.0 mm, 2.0 mm, 5 mm, 10 mm, 20 mm, and 40 mm) Maximum outer diameter: 30 mm

*Do not use the 0.5-mm, 1.0-mm, and 2.0-mm Extension Tubes next to each other.

These Extension Tubes are placed over the threaded section of the Lens or other Extension Tube. If more than one them are used together, the connection of the threaded section may not be secure.

*Reinforcement is required to protect against vibration when Extension Tubes exceeding 30 mm are used.

Cameras

ZFX-SR10/SR50

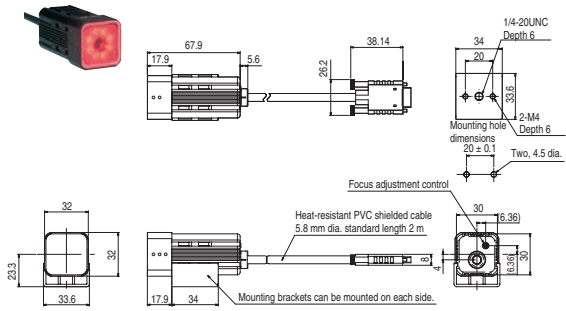

ZFX-SR10R/SR50R



ZFX-SC10

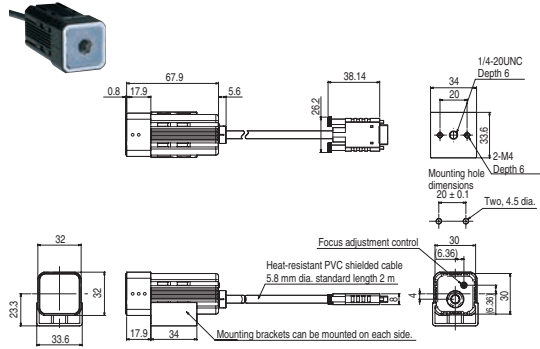

ZFX-SC10R



ZFX-SC50/SC50W

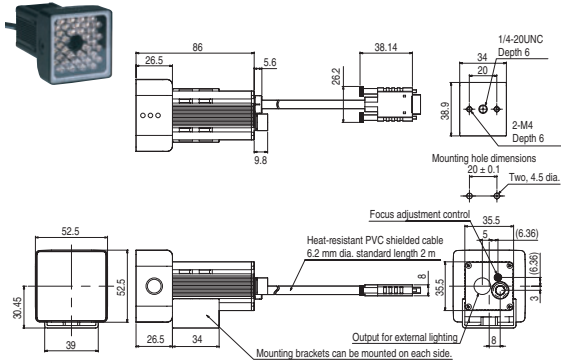

ZFX-SC50R



Cameras

ZFX-SC90/SC90W

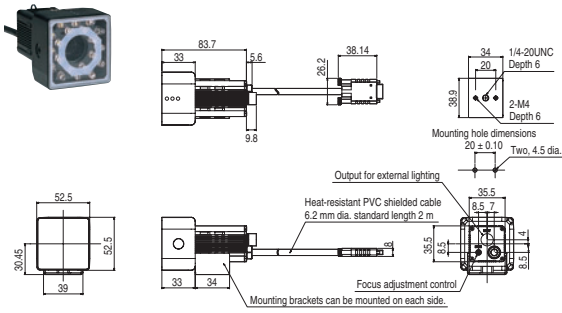

ZFX-SC90R

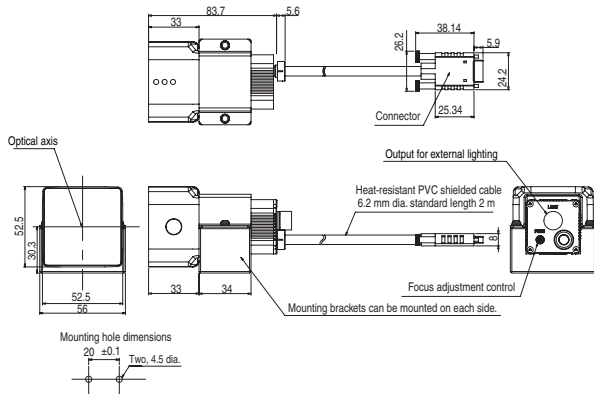

ZFX-SC150/SC150W

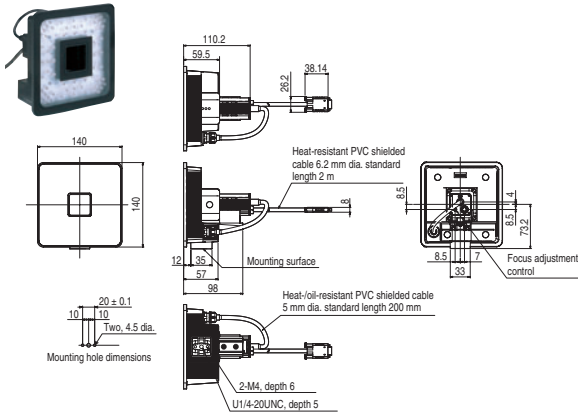

ZFX-S/SC

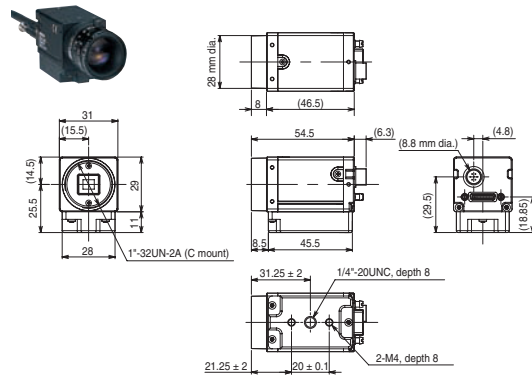

LCD Monitor

FZ-M08



Console

ZFX-KP

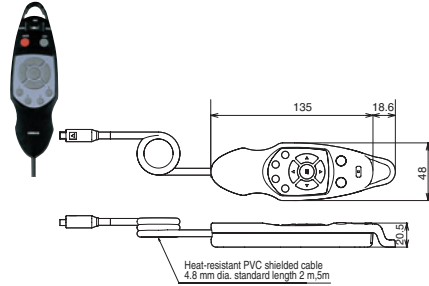

■ MEMO



■ MEMO



READ AND UNDERSTAND THIS DOCUMENT

Please read and understand this document before using the products. Please consult your OMRON representative if you have any questions or comments.

WARRANTY

OMRON's exclusive warranty is that the products are free from defects in materials and workmanship for a period of one year (or other period if specified) from date of sale by OMRON.

OMRON MAKES NO WARRANTY OR REPRESENTATION, EXPRESS OR IMPLIED, REGARDING NON-INFRINGEMENT, MERCHANTABILITY, OR FITNESS FOR PARTICULAR PURPOSE OF THE PRODUCTS. ANY BUYER OR USER ACKNOWLEDGES THAT THE BUYER OR USER ALONE HAS DETERMINED THAT THE PRODUCTS WILL SUITABLY MEET THE REQUIREMENTS OF THEIR INTENDED USE. OMRON DISCLAIMS ALL OTHER WARRANTIES, EXPRESS OR IMPLIED.

LIMITATIONS OF LIABILITY

OMRON SHALL NOT BE RESPONSIBLE FOR SPECIAL, INDIRECT, OR CONSEQUENTIAL DAMAGES, LOSS OF PROFITS OR COMMERCIAL LOSS IN ANY WAY CONNECTED WITH THE PRODUCTS, WHETHER SUCH CLAIM IS BASED ON CONTRACT, WARRANTY, NEGLIGENCE, OR STRICT LIABILITY.

In no event shall responsibility of OMRON for any act exceed the individual price of the product on which liability is asserted.

IN NO EVENT SHALL OMRON BE RESPONSIBLE FOR WARRANTY, REPAIR, OR OTHER CLAIMS REGARDING THE PRODUCTS UNLESS OMRON'S ANALYSIS CONFIRMS THAT THE PRODUCTS WERE PROPERLY HANDLED, STORED, INSTALLED, AND MAINTAINED AND NOT SUBJECT TO CONTAMINATION, ABUSE, MISUSE, OR INAPPROPRIATE MODIFICATION OR REPAIR.

SUITABILITY FOR USE

THE PRODUCTS CONTAINED IN THIS DOCUMENT ARE NOT SAFETY RATED. THEY ARE NOT DESIGNED OR RATED FOR ENSURING SAFETY OF PERSONS, AND SHOULD NOT BE RELIED UPON AS A SAFETY COMPONENT OR PROTECTIVE DEVICE FOR SUCH PURPOSES. Please refer to separate catalogs for OMRON's safety rated products.

OMRON shall not be responsible for conformity with any standards, codes, or regulations that apply to the combination of products in the customer's application or use of the product.

At the customer's request, OMRON will provide applicable third party certification documents identifying ratings and limitations of use that apply to the products. This information by itself is not sufficient for a complete determination of the suitability of the products in combination with the end product, machine, system, or other application or use.

The following are some examples of applications for which particular attention must be given. This is not intended to be an exhaustive list of all possible uses of the products, nor is it intended to imply that the uses listed may be suitable for the products:

- Outdoor use, uses involving potential chemical contamination or electrical interference, or conditions or uses not described in this document.
- Nuclear energy control systems, combustion systems, railroad systems, aviation systems, medical equipment, amusement machines, vehicles, safety equipment, and installations subject to separate industry or government regulations.
- Systems, machines, and equipment that could present a risk to life or property.

Please know and observe all prohibitions of use applicable to the products.

NEVER USE THE PRODUCTS FOR AN APPLICATION INVOLVING SERIOUS RISK TO LIFE OR PROPERTY WITHOUT ENSURING THAT THE SYSTEM AS A WHOLE HAS BEEN DESIGNED TO ADDRESS THE RISKS, AND THAT THE OMRON PRODUCT IS PROPERLY RATED AND INSTALLED FOR THE INTENDED USE WITHIN THE OVERALL EQUIPMENT OR SYSTEM.

PERFORMANCE DATA

Performance data given in this document is provided as a guide for the user in determining suitability and does not constitute a warranty. It may represent the result of OMRON's test conditions, and the users must correlate it to actual application requirements. Actual performance is subject to the OMRON Warranty and Limitations of Liability.

CHANGE IN SPECIFICATIONS

Product specifications and accessories may be changed at any time based on improvements and other reasons.

It is our practice to change model numbers when published ratings or features are changed, or when significant construction changes are made. However, some specifications of the product may be changed without any notice. When in doubt, special model numbers may be assigned to fix or establish key specifications for your application on your request. Please consult with your OMRON representative at any time to confirm actual specifications of purchased products.

DIMENSIONS AND WEIGHTS

Dimensions and weights are nominal and are not to be used for manufacturing purposes, even when tolerances are shown.

ERRORS AND OMISSIONS

The information in this document has been carefully checked and is believed to be accurate; however, no responsibility is assumed for clerical, typographical, or proofreading errors, or omissions.

PROGRAMMABLE PRODUCTS

OMRON shall not be responsible for the user's programming of a programmable product, or any consequence thereof.

COPYRIGHT AND COPY PERMISSION

This document shall not be copied for sales or promotions without permission.

This document is protected by copyright and is intended solely for use in conjunction with the product. Please notify us before copying or reproducing this document in any manner, for any other purpose. If copying or transmitting this document to another, please copy or transmit it in its entirety.

This document provides information mainly for selecting suitable models. Please read the User's Manual (Z251-E1-01) carefully for information that the user must understand and accept before purchase, including information on warranty, limitations of liability, and precautions.

OMRON Corporation Industrial Automation Company

Tokyo, JAPAN

Contact: www.ia.omron.com

Regional Headquarters

OMRON EUROPE B.V.

Sensor Business Unit

Carl-Benz-Str. 4, D-71154 Nufringen, Germany
Tel: (49) 7032-811-0/Fax: (49) 7032-811-199

OMRON ELECTRONICS LLC

One Commerce Drive Schaumburg,
IL 60173-5302 U.S.A.
Tel: (1) 847-843-7900/Fax: (1) 847-843-7787

OMRON ASIA PACIFIC PTE. LTD.

No. 438A Alexandra Road # 05-05/08 (Lobby 2),
Alexandra Technopark,
Singapore 119967
Tel: (65) 6835-3011/Fax: (65) 6835-2711

OMRON (CHINA) CO., LTD.

Room 2211, Bank of China Tower,
200 Yin Cheng Zhong Road,
PuDong New Area, Shanghai, 200120, China
Tel: (86) 21-5037-2222/Fax: (86) 21-5037-2200

Authorized Distributor:

© OMRON Corporation 2009 All Rights Reserved.
In the interest of product improvement,
specifications are subject to change without notice.

CSM_4_1_0814

Cat. No. E381-E1

Printed in Japan