

VARIABLE CAPACITANCE DIODE

FEATURES

- Very Small UFD Surface Mount Package
- Very Low Series Resistance
- Large Capacitance Ratio ($A = 2.21$ minimum)
- Excellent Linearity (CV Curve)
- Very Small Capacitance Deviation at Tape/Reel

APPLICATIONS

- UHF Communications Equipment
- Voltage Controlled Oscillator
- 900 MHz Communications Systems

DESCRIPTION

The KV1843K is a variable capacitance diode designed for UHF applications.

The KV1843K is available in a very small UFD Surface Mount Package.

ORDERING INFORMATION

KV1843K 
└─── Tape/Reel Code

TAPE/REEL CODE
TR: Tape Right

KV1843K

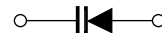

KV1843K

ABSOLUTE MAXIMUM RATINGS

Reverse Voltage 18 V Storage Temperature Range -55 to +150 °C
Forward Current 7 mA Operating Temperature Range -55 to +85 °C
Power Dissipation 25 mW

ELECTRICAL CHARACTERISTICS

Test conditions: $T_A = 25\text{ °C}$

SYMBOL	PARAMETER	TEST CONDITIONS	MIN	TYP	MAX	UNITS
V_{REV}	Reverse Voltage	$I_{REV} = 1\ \mu\text{A}$	12.0			V
I_{REV}	Reverse Current	$V_{REV} = 10\ \text{V}$			5.00	nA
C_1	Diode Capacitance 1	$V_{REV} = 1\ \text{V}, f = 1\ \text{MHz}$	17.09	18.14	19.20	pF
C_4	Diode Capacitance 4	$V_{REV} = 4\ \text{V}, f = 1\ \text{MHz}$	6.63	7.30	7.96	pF
R_S	Series Resistance	$C = 8\ \text{pF}, f = 470\ \text{MHz}$		0.35	0.40	Ω
A	Capacitance Ratio	C_1 / C_4	2.21			

Note 1: Diode Capacitance measured with HP 4279A or equivalent instruments (at OSC level 20 mVrms, $\pm 5\ \text{mVrms}$).

Note 2: Series Resistance measured with HP 4191A or equivalent instruments.

TYPICAL PERFORMANCE CHARACTERISTICS

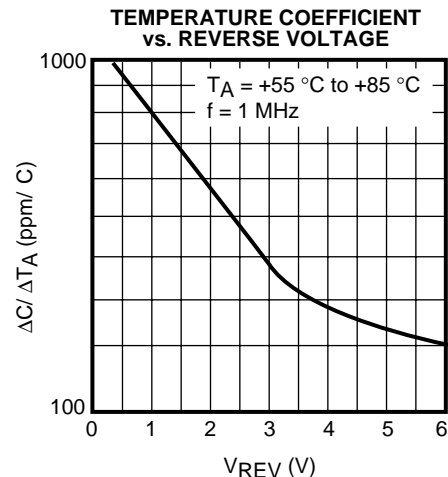
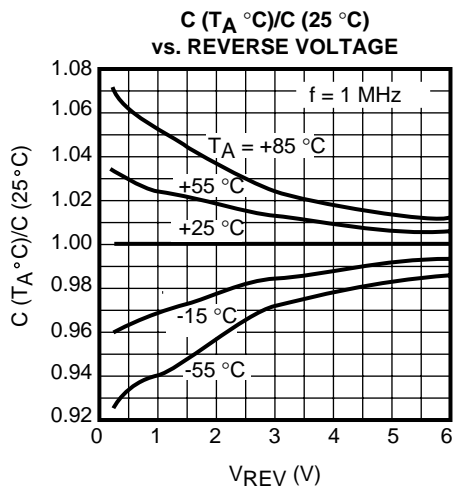
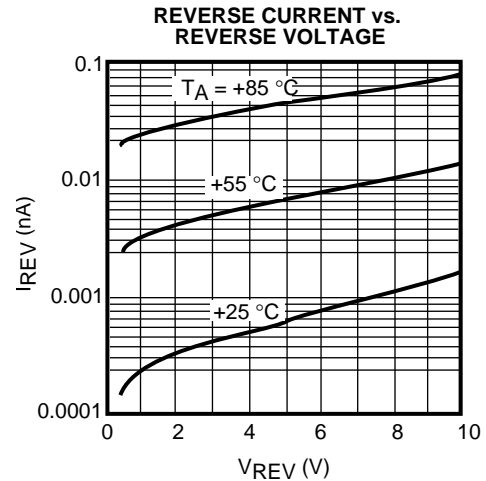
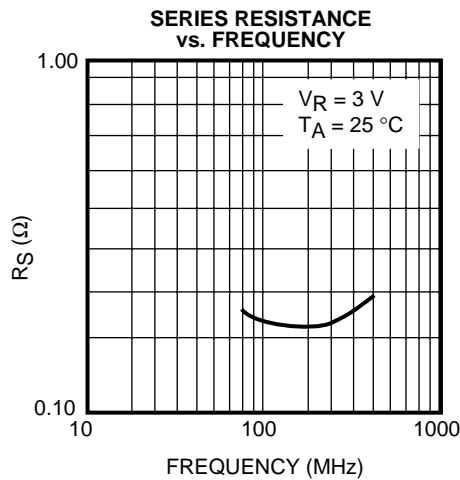
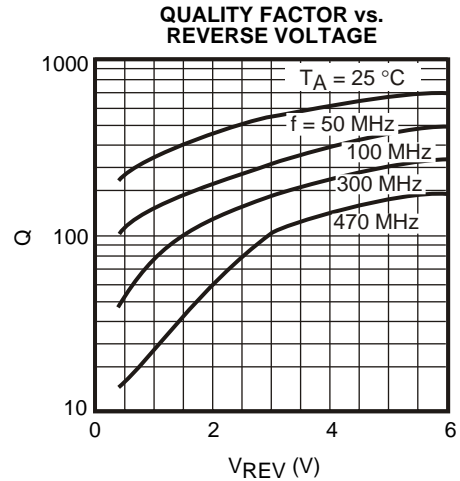
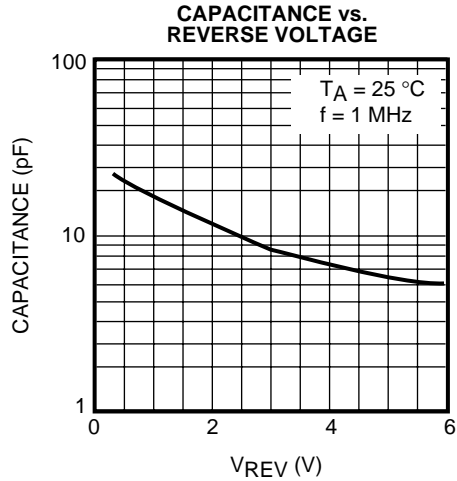

PACKAGE OUTLINE

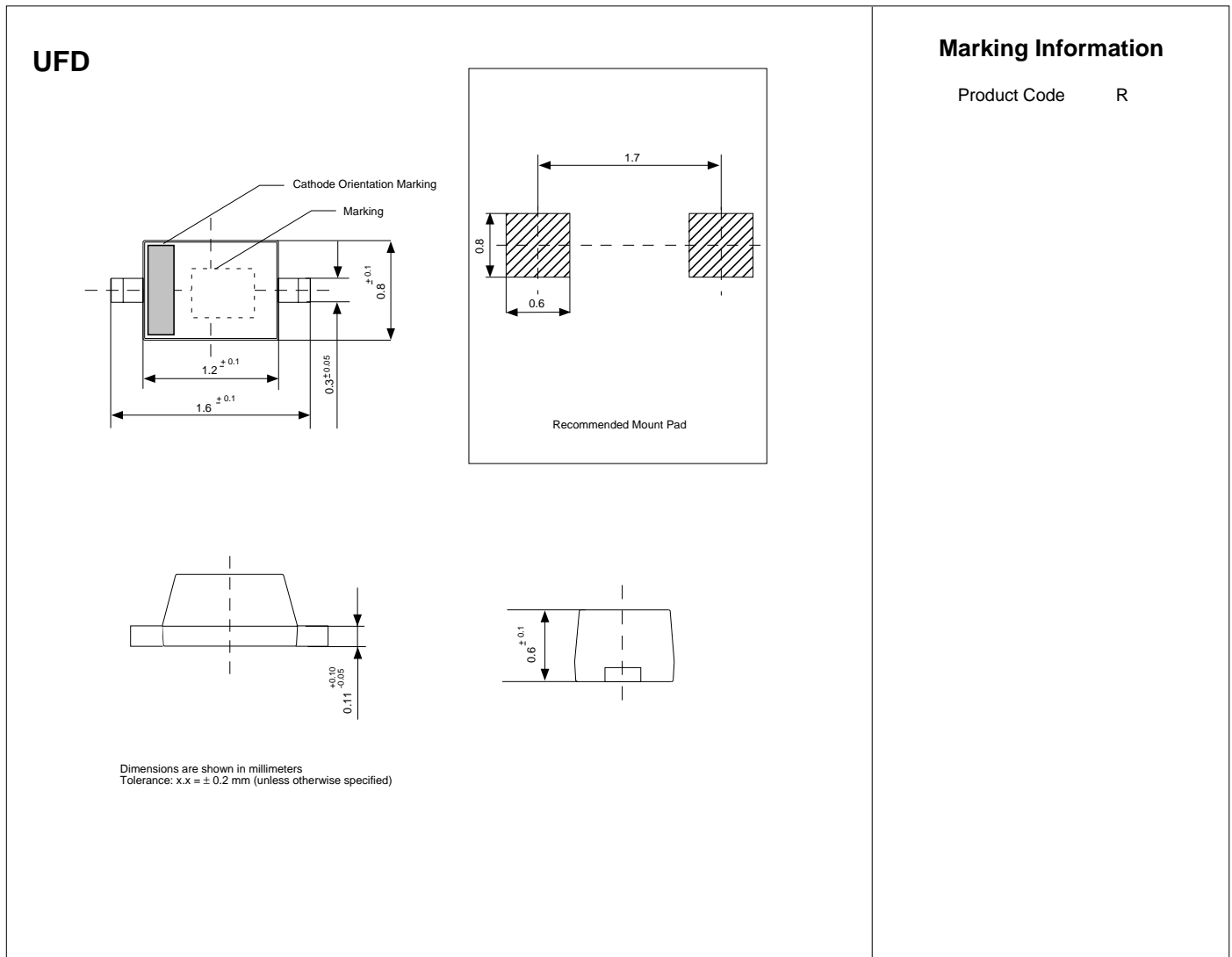

Toko America, Inc. Headquarters
 1250 Feehanville Drive, Mount Prospect, Illinois 60056
 Tel: (847) 297-0070 Fax: (847) 699-7864

TOKO AMERICA REGIONAL OFFICES

Midwest Regional Office
 Toko America, Inc.
 1250 Feehanville Drive
 Mount Prospect, IL 60056
 Tel: (847) 297-0070
 Fax: (847) 699-7864

Western Regional Office
 Toko America, Inc.
 2480 North First Street, Suite 260
 San Jose, CA 95131
 Tel: (408) 432-8281
 Fax: (408) 943-9790

Eastern Regional Office
 Toko America, Inc.
 107 Mill Plain Road
 Danbury, CT 06811
 Tel: (203) 748-6871
 Fax: (203) 797-1223

Semiconductor Technical Support
 Toko Design Center
 4755 Forge Road
 Colorado Springs, CO 80907
 Tel: (719) 528-2200
 Fax: (719) 528-2375

Visit our Internet site at <http://www.tokoam.com>

The information furnished by TOKO, Inc. is believed to be accurate and reliable. However, TOKO reserves the right to make changes or improvements in the design, specification or manufacture of its products without further notice. TOKO does not assume any liability arising from the application or use of any product or circuit described herein, nor for any infringements of patents or other rights of third parties which may result from the use of its products. No license is granted by implication or otherwise under any patent or patent rights of TOKO, Inc.

This datasheet has been download from:

www.datasheetcatalog.com

Datasheets for electronics components.