

RS6G07 6-channel Buffer and Driver with Open-Drain Outputs

FEATURES

- **Operating Voltage Range:**1.65V to 5.5V
- **Low Power Consumption:**1 μ A (Max)
- **Operating Temperature Range:**
-40°C to +125°C
- **Inputs and Open-Drain Outputs**
Accept Voltage to 5.5V
- **High Output Drive:** \pm 24mA at V_{CC} =3.0V
- **PACKAGES:** SOIC-14(SOP14)、TSSOP-14

APPLICATIONS

- Blu-ray Players and Home Theaters
- Desktops or Notebook PCs
- Digital Video Cameras (DVC)
- Mobile Phones
- Personal Navigation Device (GPS)
- Portable Media Player

Functional Block Diagram

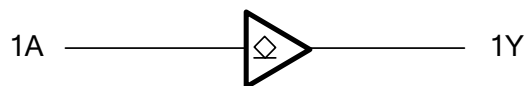

DESCRIPTION

The RS6G07 6-channel buffer and driver is designed for 1.65V to 5.5V V_{CC} operation.

The RS6G07 device is open drain and can be connected to other open-drain outputs to implement active-low wired-OR or active-high wired-AND functions. The device is fully specified for partial-power-down applications using I_{off} . The I_{off} circuitry disables the outputs, preventing damaging current backflow through the device when it is powered down.

The RS6G07 is available in Green SOIC-14(SOP14) and TSSOP-14 packages. It operates over an ambient temperature range of -40°C to +125°C.

Device Information ⁽¹⁾

PART NUMBER	PACKAGE	BODY SIZE (NOM)
RS6G07	SOIC-14(SOP14)	8.65mmx3.90mm
	TSSOP-14	5.00mmx4.40mm

(1) For all available packages, see the orderable addendum at the end of the data sheet.

FUNCTION TABLE

INPUT	OUTPUT
A	Y
L	L
H	Z

H=High Voltage Level

L=Low Voltage Level

Z=High-impedance OFF-state

Revision History

Note: Page numbers for previous revisions may differ from page numbers in the current version.

VERSION	Change Date	Change Item
A.1	2021/04/20	Initial version completed
A.2	2021/12/20	Added the TAPE AND REEL INFORMATION
A.3	2022/03/29	1. Modify V_O on page 4@A.2 Version 2. Delete V_{OH} on page 7@A.2 Version
A.4	2022/04/06	Update the ESD Ratings

Pin Configuration and Functions

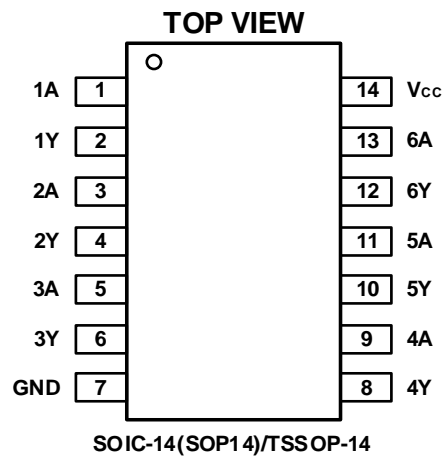

Pin Description

NAME	PIN	I/O	DESCRIPTION
	SOIC-14(SOP14)/TSSOP-14		
1A	1	I	Input 1
1Y	2	O	Open-drain output 1
2A	3	I	Input 2
2Y	4	O	Open-drain output 2
3A	5	I	Input 3
3Y	6	O	Open-drain output 3
GND	7	P	Ground
4Y	8	O	Open-drain output 4
4A	9	I	Input 4
5Y	10	O	Open-drain output 5
5A	11	I	Input 5
6Y	12	O	Open-drain output 6
6A	13	I	Input 6
V _{CC}	14	P	Power pin

SPECIFICATIONS

Absolute Maximum Ratings ⁽¹⁾

over operating free-air temperature range (unless otherwise noted) ⁽¹⁾ ⁽²⁾

		MIN	MAX	UNIT
V _{CC}	Supply voltage range	-0.5	6.5	V
V _I	Input voltage range ⁽²⁾	-0.5	6.5	V
V _O	Output voltage range ⁽²⁾	-0.5	6.5	V
I _{IK}	Input clamp current	V _I <0	-50	mA
I _{OK}	Output clamp current	V _O <0	-50	mA
I _O	Continuous output current		±50	mA
	Continuous current through V _{CC} or GND		±100	mA
T _J	Junction temperature	-65	150	°C
T _{stg}	Storage temperature	-65	150	°C

(1) Stresses beyond those listed under *Absolute Maximum Ratings* may cause permanent damage to the device. These are stress ratings only, and functional operation of the device at these or any other conditions beyond those indicated under *Recommended Operating Conditions* is not implied. Exposure to absolute-maximum-rated conditions for extended periods may affect device reliability.

(2) The input and output negative-voltage ratings may be exceeded if the input and output current ratings are observed.

ESD Ratings

		VALUE	UNIT
V _(ESD)	Electrostatic discharge		
	Human-body model (HBM)	±7000	V
	Charged device model (CDM)	±1500	V
	Machine model (MM)	±400	V

Thermal Information:

THERMAL METRIC		RS6G07		UNIT
		14PINS		
		SOIC-14(SOP14)	TSSOP-14	
R _{θJA}	Junction-to-ambient thermal resistance	122.2	141.2	°C/W
R _{θJC(top)}	Junction-to-case(top) thermal resistance	80.9	78.8	°C/W
R _{θJB}	Junction-to-board thermal resistance	80.6	85.8	°C/W
Ψ _{JT}	Junction-to-top characterization parameter	40.4	27.7	°C/W
Ψ _{JB}	Junction-to-board characterization parameter	80.3	85.5	°C/W
R _{θJC(bot)}	Junction-to-case(bottom) thermal resistance	N/A	N/A	°C/W

PACKAGE/ORDERING INFORMATION

PRODUCT	ORDERING NUMBER	TEMPERATURE RANGE	PACKAGE LEAD	PACKAGE MARKING ⁽¹⁾	PACKAGE OPTION
RS6G07	RS6G07XP	-40°C ~+125°C	SOIC-14(SOP14)	RS6G07	Tape and Reel,4000
	RS6G07XQ	-40°C ~+125°C	TSSOP-14	RS6G07	Tape and Reel,4000

NOTE:

- (1) There may be additional marking, which relates to the lot trace code information (data code and vendor code), the logo or the environmental category on the device.

ELECTRICAL CHARACTERISTICS

over recommended operating free-air temperature range (TYP values are at $T_A = +25^{\circ}\text{C}$, unless otherwise noted.) ⁽¹⁾

Recommended Operating Conditions

PARAMETER	SYMBOL	TEST CONDITIONS	MIN	MAX	UNIT
Supply voltage	V_{CC}	Operating	1.65	5.5	V
		Data retention only	1.5		
High-level input voltage	V_{IH}	$V_{CC}=1.65\text{V to }1.95\text{V}$	$0.65 \times V_{CC}$		V
		$V_{CC}=2.3\text{V to }2.7\text{V}$	1.7		
		$V_{CC}=3\text{V to }3.6\text{V}$	2.2		
		$V_{CC}=4.5\text{V to }5.5\text{V}$	$0.7 \times V_{CC}$		
Low-level input voltage	V_{IL}	$V_{CC}=1.65\text{V to }1.95\text{V}$		$0.15 \times V_{CC}$	V
		$V_{CC}=2.3\text{V to }2.7\text{V}$		0.3	
		$V_{CC}=3\text{V to }3.6\text{V}$		0.4	
		$V_{CC}=4.5\text{V to }5.5\text{V}$		$0.15 \times V_{CC}$	
Input voltage	V_I		0	5.5	V
Output voltage	V_O		0	5.5	V
Input transition rise or fall	$\Delta t/\Delta v$	$V_{CC}=1.8\text{V} \pm 0.15\text{V}, 2.5\text{V} \pm 0.2\text{V}$		20	ns/V
		$V_{CC}=3.3\text{V} \pm 0.3\text{V}$		10	
		$V_{CC}=5\text{V} \pm 0.5\text{V}$		5	
Operating temperature	T_A		-40	+125	$^{\circ}\text{C}$

(1) All unused inputs of the device must be held at V_{CC} or GND to ensure proper device operation.

DC Characteristics

PARAMETER		TEST CONDITIONS	V _{CC}	TEMP	MIN	TYP	MAX	UNIT
V _{OL}	I _{OL} = 100μA		1.65V to 5.5V	Full			0.1	V
	I _{OL} = 4mA		1.65V				0.45	
	I _{OL} = 8mA		2.3V				0.3	
	I _{OL} = 16mA		3V				0.4	
	I _{OL} = 24mA						0.55	
	I _{OL} = 32mA		4.5V				0.55	
I _i	A or B inputs	V _I =5.5V or GND	0V to 5.5V	+25°C		±0.1	±1	μA
				Full			±5	
I _{off}		V _I or V _O =5.5V	0V	+25°C		±0.1	±1	μA
				Full			±10	
I _{CC}		V _I =5.5V or GND, I _o =0	1.65V to 5.5V	+25°C		0.1	1	μA
				Full			10	
ΔI _{CC}		One input at V _{CC} -0.6V, Other inputs at V _{CC} or GND	3V to 5.5V	Full			500	μA

AC Characteristics

PARAMETER	SYMBOL	TEST CONDITIONS		TEMP	MIN	TYP	MAX	UNIT
Propagation Delay	t _{pd}	V _{CC} =1.8V±0.15V	C _L =30pF, R _L =1kΩ	Full		6.4		ns
		V _{CC} =2.5V±0.2V	C _L =30pF, R _L =500Ω	Full		4.5		
		V _{CC} =3.3V±0.3V	C _L =50pF, R _L =500Ω	Full		4.2		
		V _{CC} =5V±0.5V	C _L =50pF, R _L =500Ω	Full		3.7		
Input Capacitance	C _i	V _{CC} =3.3V	V _I =V _{CC} or GND	+25°C		4		pF
Power dissipation capacitance	C _{pd}	V _{CC} =1.8V	f=10MHz	+25°C		3		pF
		V _{CC} =2.5V				3		
		V _{CC} =3.3V				4		
		V _{CC} =5V				6		

(1) All unused inputs of the device must be held at V_{CC} or GND to ensure proper device operation.

Parameter Measurement Information

Open-Drain

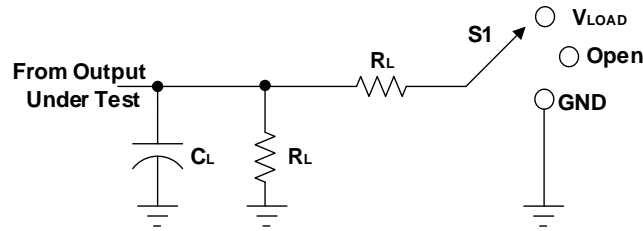

TEST	S1
t_{PLH}/t_{PHL}	Open
t_{PLZ}/t_{PZL}	V_{LOAD}
t_{PHZ}/t_{PZH}	GND

V_{CC}	INPUTS		V_M	V_{LOAD}	C_L		R_L		V_{Δ}
	V_I	t_r/t_f							
$1.8V \pm 0.15V$	V_{CC}	$\leq 2ns$	$V_{CC}/2$	$2 \times V_{CC}$	15pF	30pF	1M Ω	1k Ω	0.15V
$2.5V \pm 0.2V$	V_{CC}	$\leq 2ns$	$V_{CC}/2$	$2 \times V_{CC}$	15pF	30pF	1M Ω	500 Ω	0.15V
$3.3V \pm 0.3V$	3V	$\leq 2.5ns$	1.5V	6V	15pF	50pF	1M Ω	500 Ω	0.3V
$5V \pm 0.5V$	V_{CC}	$\leq 2.5ns$	$V_{CC}/2$	$2 \times V_{CC}$	15pF	50pF	1M Ω	500 Ω	0.3V

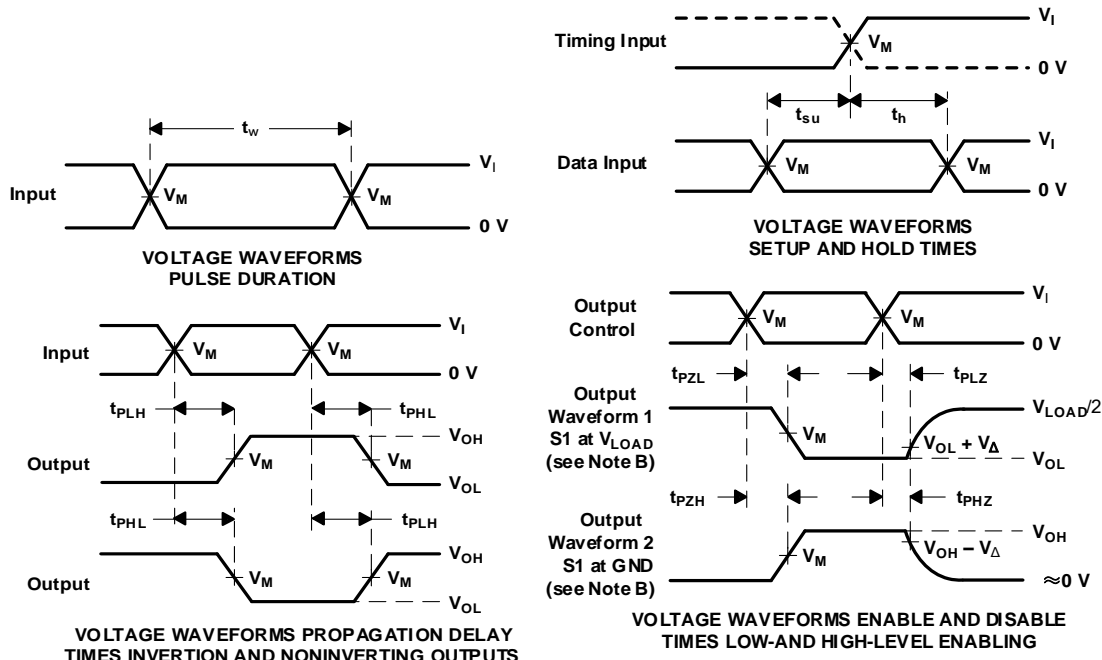

- NOTES:
- A. C_L includes probe and jig capacitance.
 - B. Waveform 1 is for an output with internal conditions such that the output is low, except when disabled by the output control. Waveform 2 is for an output with internal conditions such that the output is high, except when disabled by the output control.
 - C. All input pulses are supplied by generators having the following characteristics: PRR \leq 10 MHz, $Z_o = 50 \Omega$.
 - D. The outputs are measured one at a time, with one transition per measurement.
 - E. t_{PLZ} and t_{PHZ} are the same as t_{dis} .
 - F. t_{PZL} and t_{PZH} are the same as t_{en} .
 - G. t_{PLH} and t_{PHL} are the same as t_{pd} .
 - H. All parameters and waveforms are not applicable to all devices.

Figure 1. Load Circuit and Voltage Waveforms

PACKAGE OUTLINE DIMENSIONS

SOIC-14(SOP14)

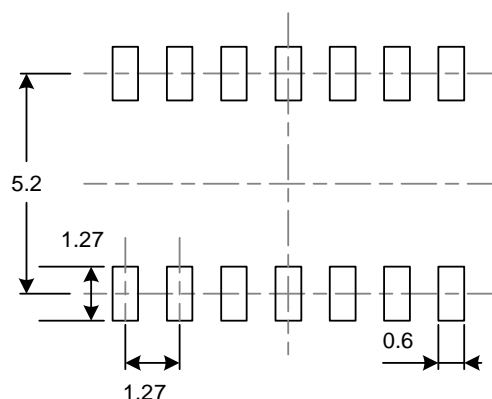
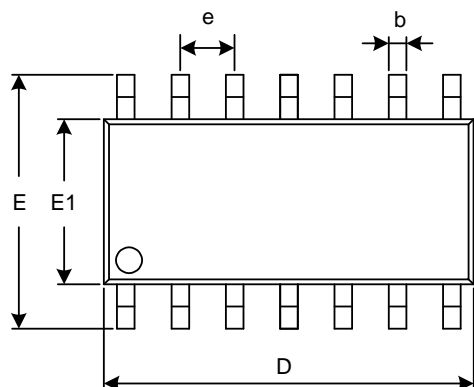

RECOMMENDED LAND PATTERN (Unit: mm)

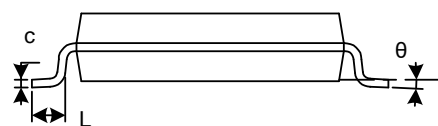
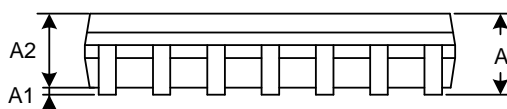

Symbol	Dimensions In Millimeters		Dimensions In Inches	
	Min	Max	Min	Max
A	1.350	1.750	0.053	0.069
A1	0.100	0.250	0.004	0.010
A2	1.350	1.550	0.053	0.061
b	0.310	0.510	0.012	0.020
c	0.100	0.250	0.004	0.010
D	8.450	8.850	0.333	0.348
e	1.270(BSC)		0.050(BSC)	
E	5.800	6.200	0.228	0.244
E1	3.800	4.000	0.150	0.157
L	0.400	1.270	0.016	0.050
θ	0°	8°	0°	8°

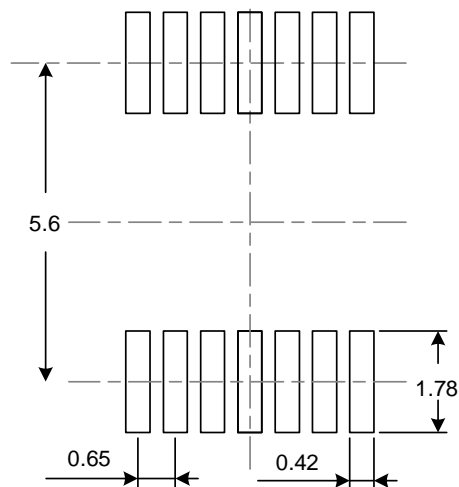
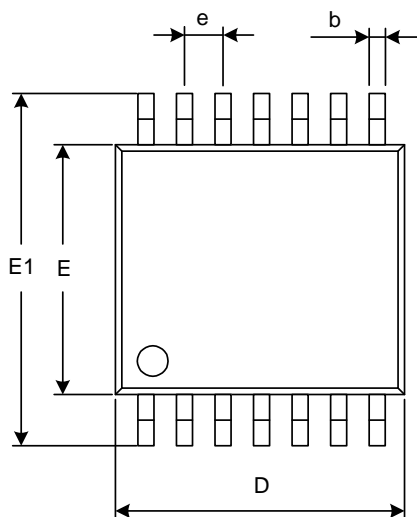
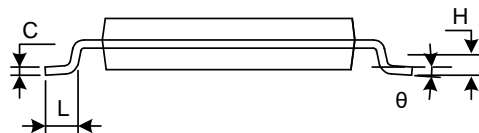
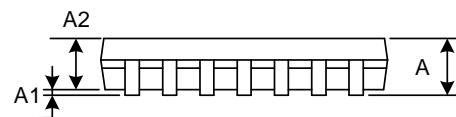
TSSOP-14

RECOMMENDED LAND PATTERN (Unit: mm)

Symbol	Dimensions In Millimeters		Dimensions In Inches	
	Min	Max	Min	Max
A		1.200		0.047
A1	0.050	0.150	0.002	0.006
A2	0.800	1.050	0.031	0.041
b	0.190	0.300	0.007	0.012
c	0.090	0.200	0.004	0.008
D	4.860	5.100	0.191	0.201
E	4.300	4.500	0.169	0.177
E1	6.250	6.550	0.246	0.258
e	0.650(BSC)		0.026(BSC)	
L	0.500	0.700	0.020	0.028
H	0.25(TYP)		0.01(TYP)	
θ	1°	7°	1°	7°

TAPE AND REEL INFORMATION

REEL DIMENSIONS

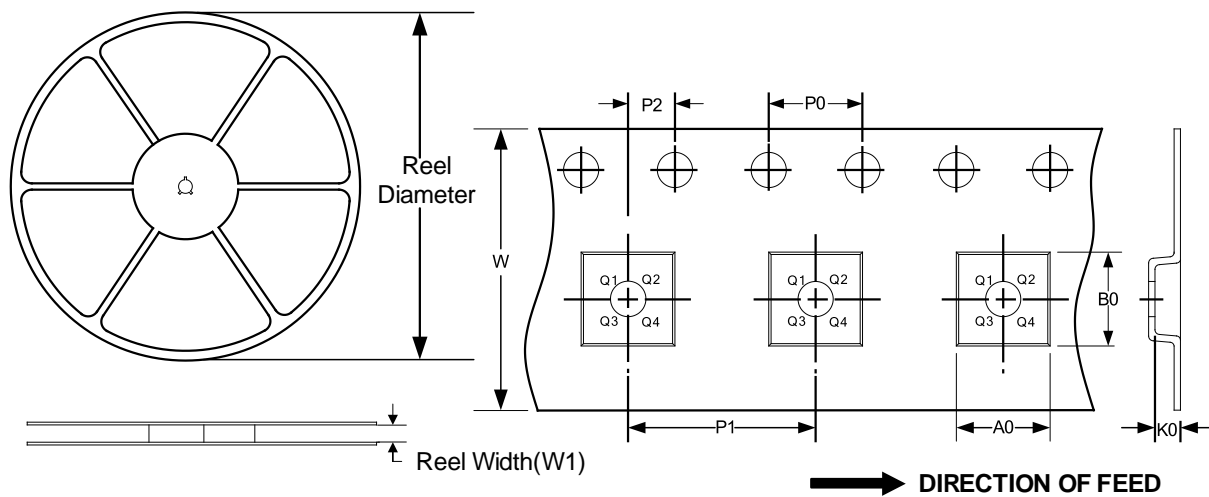
TAPE DIMENSION



NOTE: The picture is only for reference. Please make the object as the standard.

KEY PARAMETER LIST OF TAPE AND REEL

Package Type	Reel Diameter	Reel Width(mm)	A0 (mm)	B0 (mm)	K0 (mm)	P0 (mm)	P1 (mm)	P2 (mm)	W (mm)	Pin1 Quadrant
SOIC-14(SOP14)	13"	16.4	6.60	9.30	2.10	4.0	8.0	2.0	16.0	Q1
TSSOP-14	13"	12.4	6.95	5.60	1.20	4.0	8.0	2.0	12.0	Q1