

Features

- $I_{T(RMS)}$: 3 A
- V_{DRM} : 600 V
- $I_{FGT I}$, $I_{RGT I}$, $I_{RGT III}$: 15 mA (10 mA)^{Note3}
- Insulated Type
- Planar Passivation Type
- UL Recognized : Yellow Card No. E223904
File No. E80271

Outline

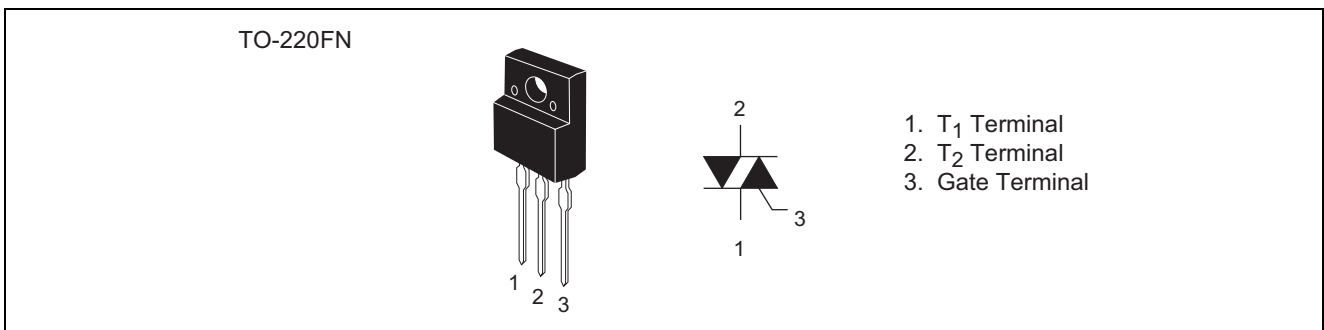

Applications

Electric rice cooker, electric pot, and controller for other heater

Maximum Ratings

Parameter	Symbol	Voltage class	Unit
		12	
Repetitive peak off-state voltage ^{Note1}	V_{DRM}	600	V
Non-repetitive peak off-state voltage ^{Note1}	V_{DSM}	720	V

Parameter	Symbol	Ratings	Unit	Conditions
RMS on-state current	$I_{T(RMS)}$	3.0	A	Commercial frequency, sine full wave 360° conduction, $T_c = 111^\circ\text{C}$
Surge on-state current	I_{TSM}	30	A	60Hz sinewave 1 full cycle, peak value, non-repetitive
I^2t for fusing	I^2t	3.7	A^2s	Value corresponding to 1 cycle of half wave 60Hz, surge on-state current
Peak gate power dissipation	P_{GM}	3	W	
Average gate power dissipation	$P_{G(AV)}$	0.3	W	
Peak gate voltage	V_{GM}	6	V	
Peak gate current	I_{GM}	0.5	A	
Junction temperature	T_j	- 40 to +125	$^\circ\text{C}$	
Storage temperature	T_{stg}	- 40 to +125	$^\circ\text{C}$	
Mass	—	2.0	g	
Isolation voltage	V_{iso}	2000	V	$T_a = 25^\circ\text{C}$, AC 1 minute, $T_1 \cdot T_2 \cdot G$ terminal to case

Notes: 1. Gate open.

Electrical Characteristics

Parameter	Symbol	Min.	Typ.	Max.	Unit	Test conditions	
Repetitive peak off-state current	I_{DRM}	—	—	2.0	mA	$T_j = 125^\circ\text{C}$, V_{DRM} applied	
On-state voltage	V_{TM}	—	—	1.5	V	$T_c = 25^\circ\text{C}$, $I_{TM} = 4.5\text{ A}$, Instantaneous measurement	
Gate trigger voltage ^{Note2}	I	$V_{FGT\ I}$	—	—	1.5	V	$T_j = 25^\circ\text{C}$, $V_D = 6\text{ V}$, $R_L = 6\ \Omega$, $R_G = 330\ \Omega$
	II	$V_{RGT\ I}$	—	—	1.5	V	
	III	$V_{RGT\ III}$	—	—	1.5	V	
Gate trigger current ^{Note2}	I	$I_{FGT\ I}$	—	—	15 ^{Note3}	mA	$T_j = 25^\circ\text{C}$, $V_D = 6\text{ V}$, $R_L = 6\ \Omega$, $R_G = 330\ \Omega$
	II	$I_{RGT\ I}$	—	—	15 ^{Note3}	mA	
	III	$I_{RGT\ III}$	—	—	15 ^{Note3}	mA	
Gate non-trigger voltage	V_{GD}	0.2	—	—	V	$T_j = 125^\circ\text{C}$, $V_D = 1/2V_{DRM}$	
Thermal resistance	$R_{th(j-c)}$	—	—	4.0	$^\circ\text{C/W}$	Junction to case ^{Note4}	
Thermal resistance	$R_{th(j-a)}$	—	—	50	$^\circ\text{C/W}$	Junction to ambient	

Notes: 2. Measurement using the gate trigger characteristics measurement circuit.

3. High sensitivity ($I_{GT} \leq 10\text{ mA}$) is also available. (I_{GT} item: 1)

4. The contact thermal resistance $R_{th(c-f)}$ in case of greasing is 0.5°C/W .

Performance Curves

Maximum On-State Characteristics

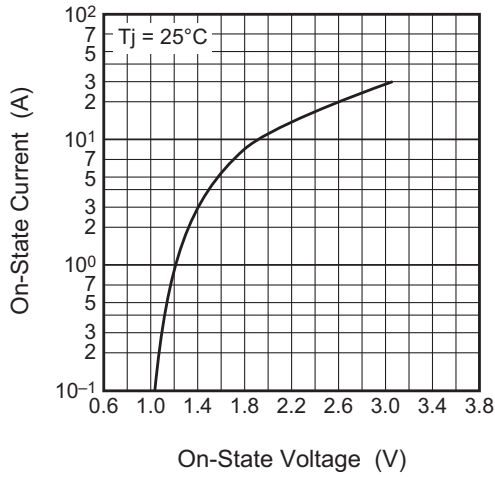

Rated Surge On-State Current

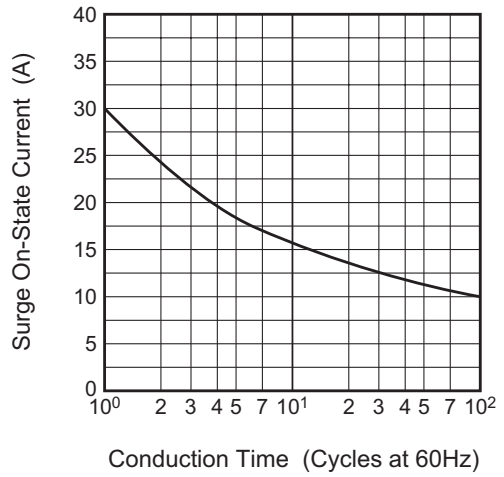

Gate Characteristics (I, II and III)

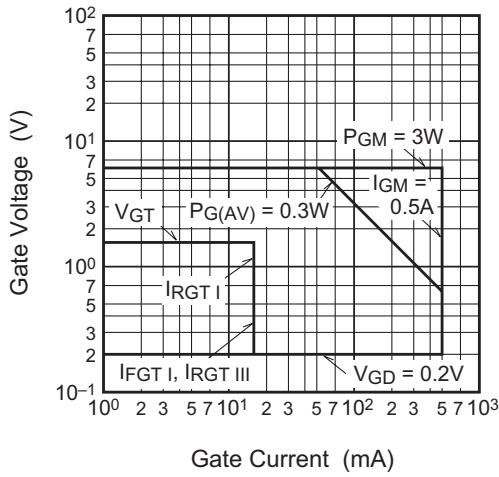

Gate Trigger Current vs. Junction Temperature

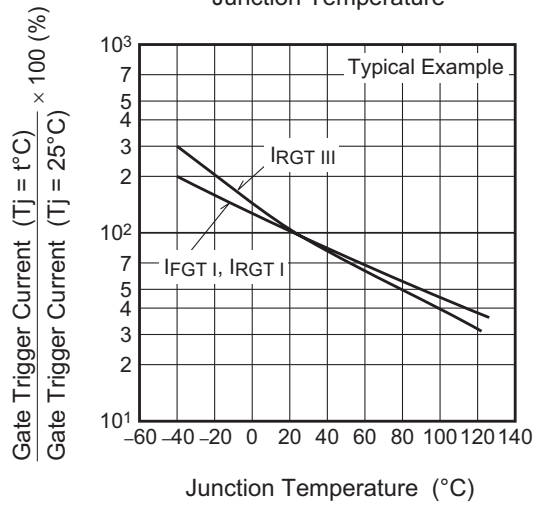

Gate Trigger Voltage vs. Junction Temperature

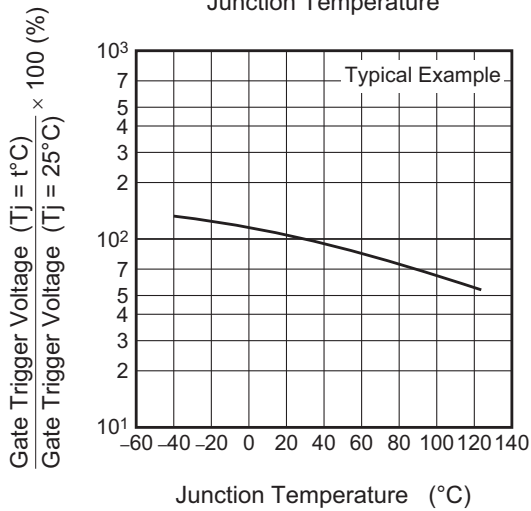

Maximum Transient Thermal Impedance Characteristics (Junction to case)

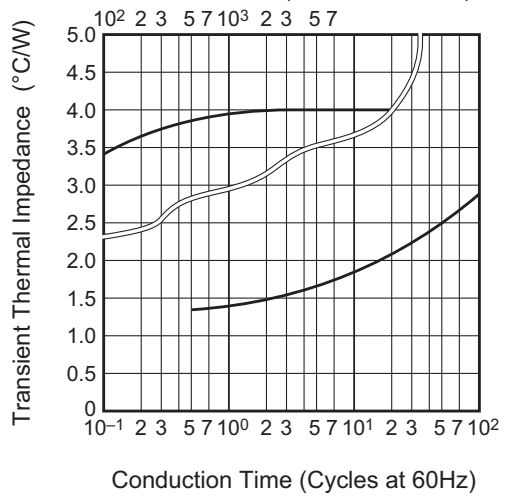

Maximum Transient Thermal Impedance Characteristics (Junction to ambient)

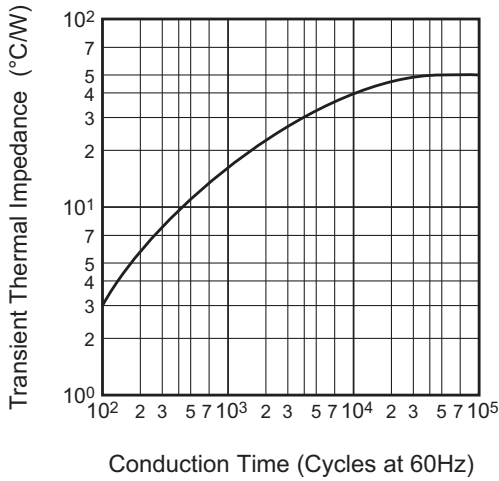

Maximum On-State Power Dissipation

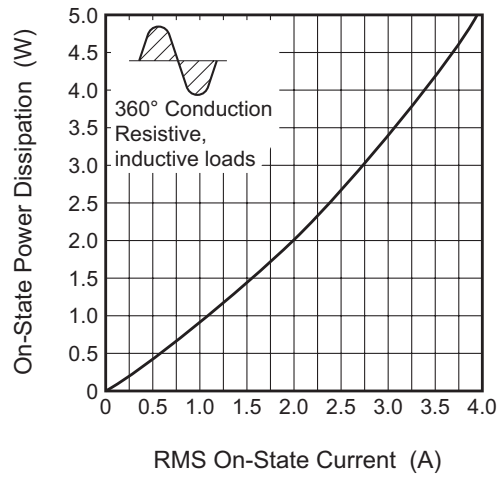

Allowable Case Temperature vs. RMS On-State Current

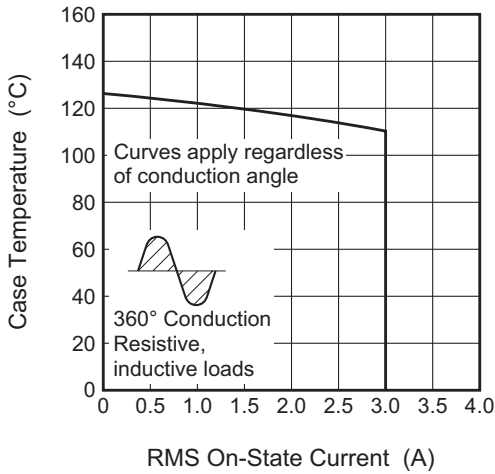

Allowable Ambient Temperature vs. RMS On-State Current

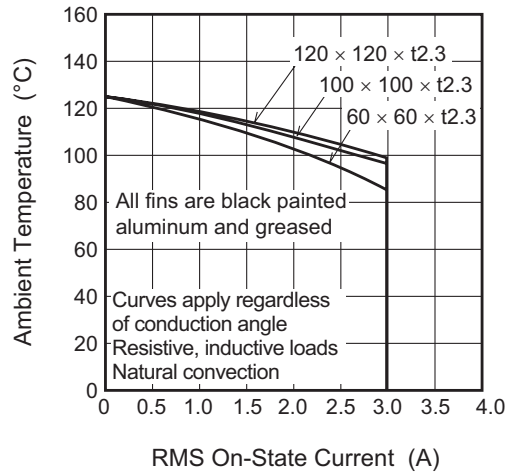

Allowable Ambient Temperature vs. RMS On-State Current

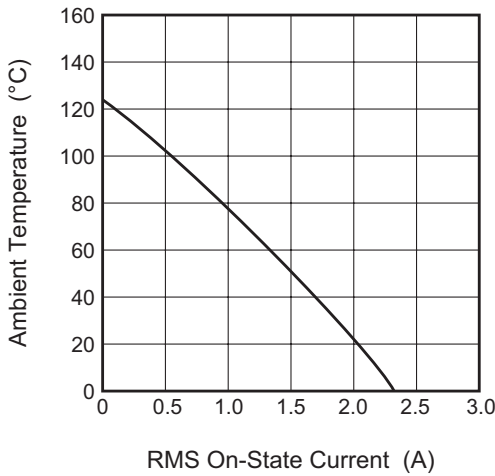

Repetitive Peak Off-State Current vs. Junction Temperature

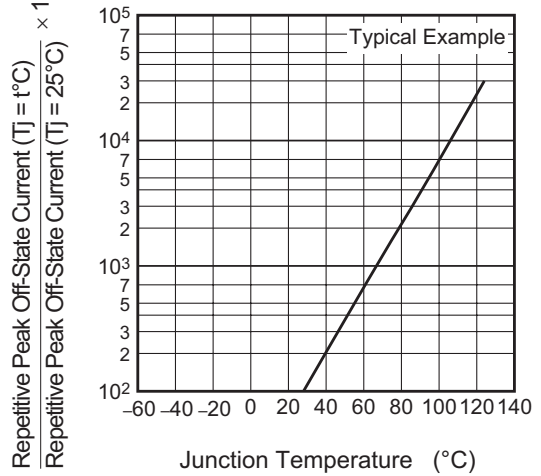

Holding Current vs. Junction Temperature

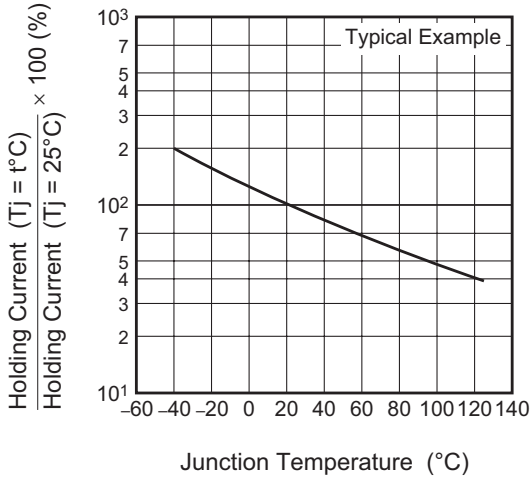

Latching Current vs. Junction Temperature

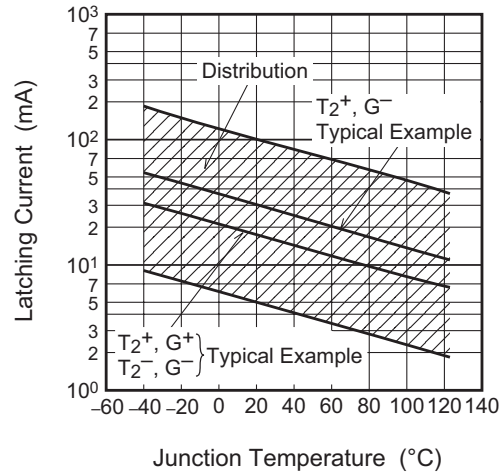

Breakover Voltage vs. Junction Temperature

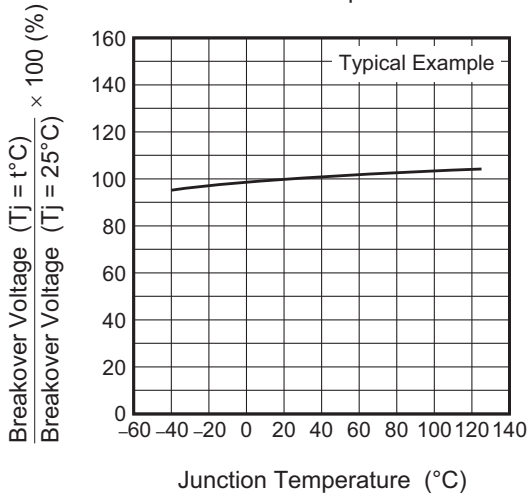

Breakover Voltage vs. Rate of Rise of Off-State Voltage

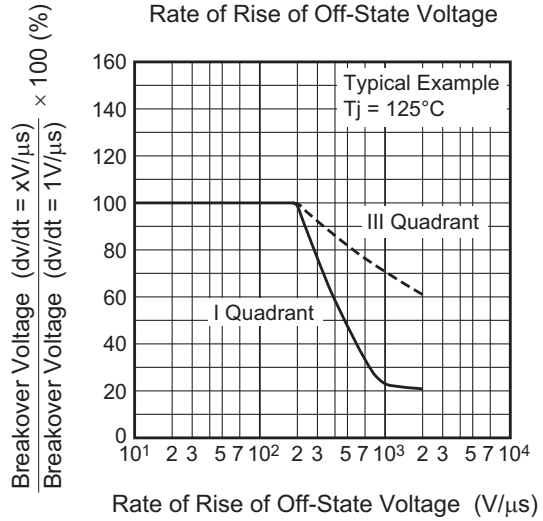

Gate Trigger Current vs. Gate Current Pulse Width

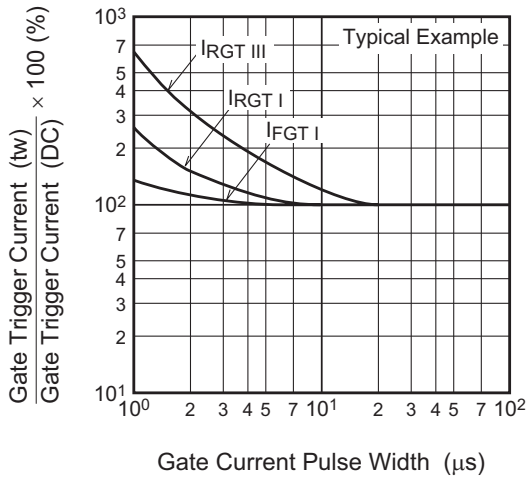

Gate Trigger Characteristics Test Circuits

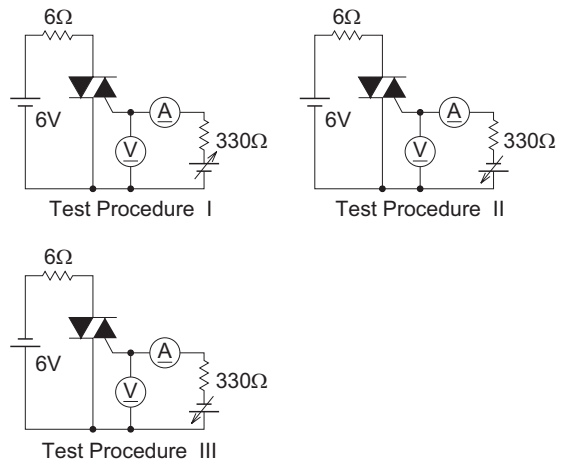

Package Dimensions

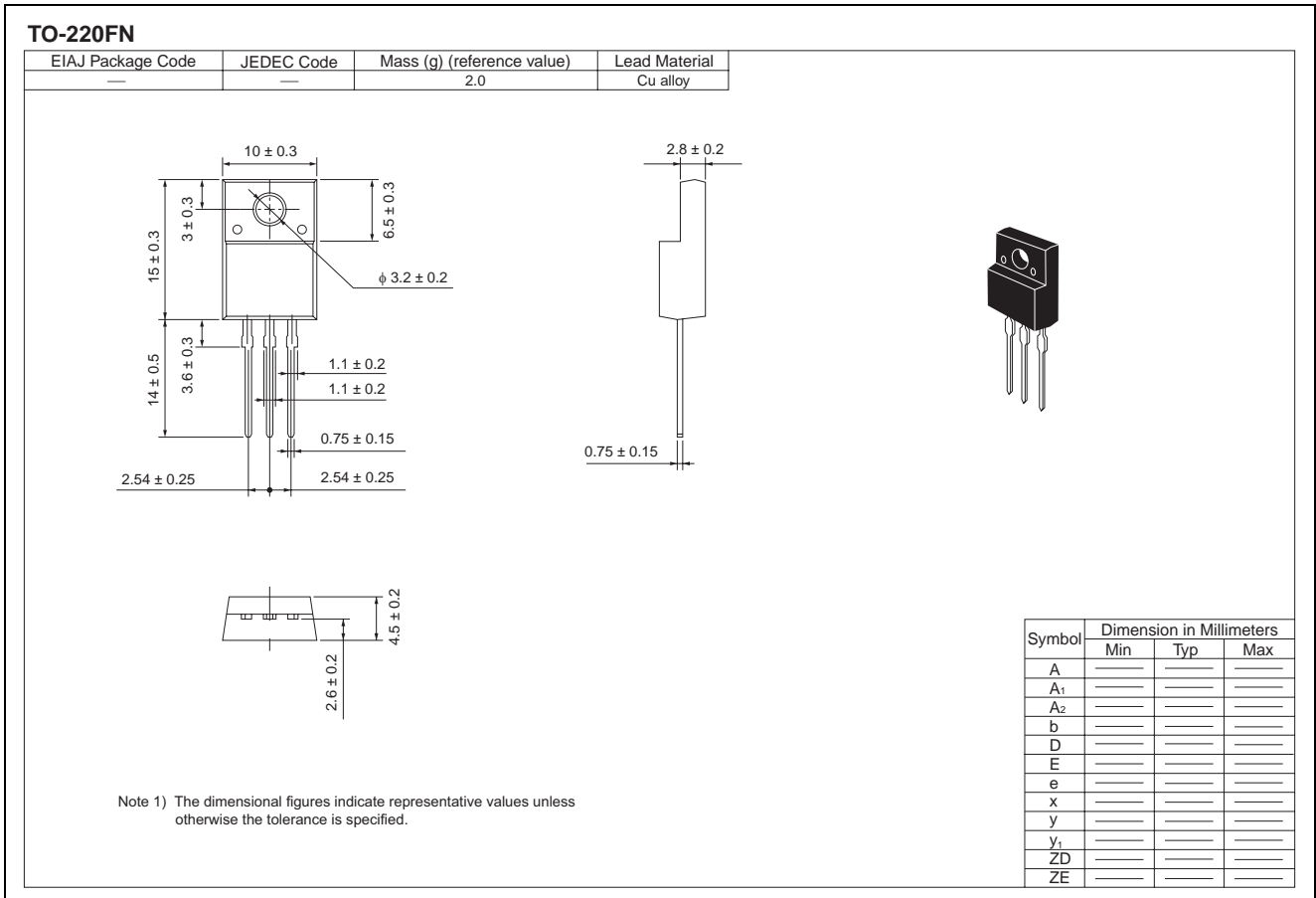

Order Code

Lead form	Standard packing	Quantity	Standard order code	Standard order code example
Straight type	Plastic Magazine (Tube)	50	Type name +RA	BCR3KM-12RA
Lead form	Plastic Magazine (Tube)	50	Type name +RA – Lead forming code	BCR3KM-12RA-A8

Note : Please confirm the specification about the shipping in detail.

Parameter	Symbol	Ratings	Unit	Conditions
RMS on-state current	$I_{T(RMS)}$	3.0	A	Commercial frequency, sine full wave 360° conduction, $T_c = 136^\circ\text{C}$
Surge on-state current	I_{TSM}	30	A	60Hz sinewave 1 full cycle, peak value, non-repetitive
I^2t for fusing	I^2t	3.7	A^2s	Value corresponding to 1 cycle of half wave 60Hz, surge on-state current
Peak gate power dissipation	P_{GM}	3	W	
Average gate power dissipation	$P_{G(AV)}$	0.3	W	
Peak gate voltage	V_{GM}	6	V	
Peak gate current	I_{GM}	0.5	A	
Junction temperature	T_j	- 40 to +150	$^\circ\text{C}$	
Storage temperature	T_{stg}	- 40 to +150	$^\circ\text{C}$	
Mass	—	2.0	g	
Isolation voltage	V_{iso}	2000	V	$T_a = 25^\circ\text{C}$, AC 1 minute, $T_1 \cdot T_2 \cdot G$ terminal to case

Notes: 1. Gate open.

Electrical Characteristics

Parameter	Symbol	Min.	Typ.	Max.	Unit	Test conditions	
Repetitive peak off-state current	I_{DRM}	—	—	2.0	mA	$T_j = 150^\circ\text{C}$, V_{DRM} applied	
On-state voltage	V_{TM}	—	—	1.5	V	$T_c = 25^\circ\text{C}$, $I_{TM} = 4.5 \text{ A}$, Instantaneous measurement	
Gate trigger voltage ^{Note2}	I	$V_{FGT I}$	—	—	1.5	V	$T_j = 25^\circ\text{C}$, $V_D = 6 \text{ V}$, $R_L = 6 \Omega$, $R_G = 330 \Omega$
	II	$V_{RGT I}$	—	—	1.5	V	
	III	$V_{RGT III}$	—	—	1.5	V	
Gate trigger current ^{Note2}	I	$I_{FGT I}$	—	—	15 ^{Note3}	mA	$T_j = 25^\circ\text{C}$, $V_D = 6 \text{ V}$, $R_L = 6 \Omega$, $R_G = 330 \Omega$
	II	$I_{RGT I}$	—	—	15 ^{Note3}	mA	
	III	$I_{RGT III}$	—	—	15 ^{Note3}	mA	
Gate non-trigger voltage	V_{GD}	0.2/0.1	—	—	V	$T_j = 125^\circ\text{C}/150^\circ\text{C}$, $V_D = 1/2V_{DRM}$	
Thermal resistance	$R_{th(j-c)}$	—	—	4.0	$^\circ\text{C}/\text{W}$	Junction to case ^{Note4}	
Thermal resistance	$R_{th(j-a)}$	—	—	50	$^\circ\text{C}/\text{W}$	Junction to ambient	

Notes: 2. Measurement using the gate trigger characteristics measurement circuit.

3. High sensitivity ($I_{GT} \leq 10 \text{ mA}$) is also available. (I_{GT} item: 1)

4. The contact thermal resistance $R_{th(c-f)}$ in case of greasing is $0.5^\circ\text{C}/\text{W}$.

Maximum On-State Characteristics

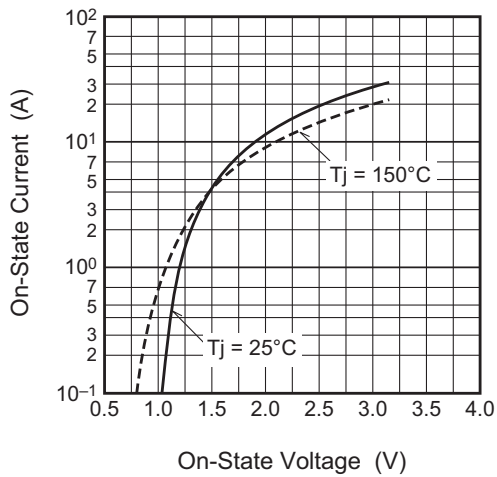

Rated Surge On-State Current

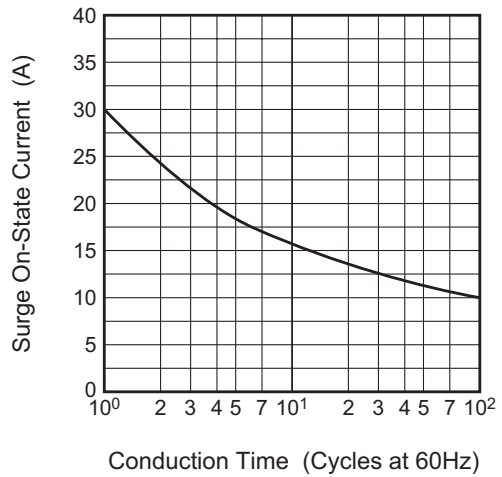

Gate Characteristics (I, II and III)

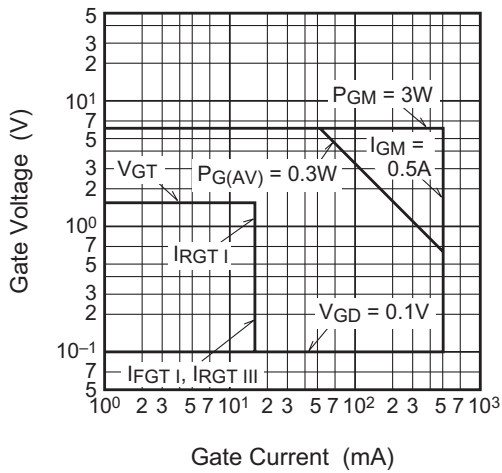

Gate Trigger Current vs. Junction Temperature

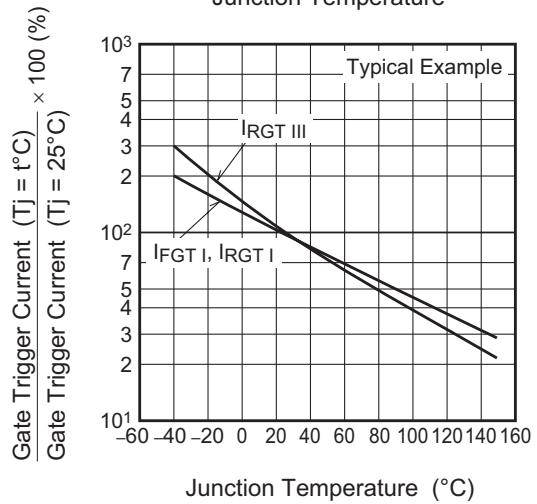

Gate Trigger Voltage vs. Junction Temperature

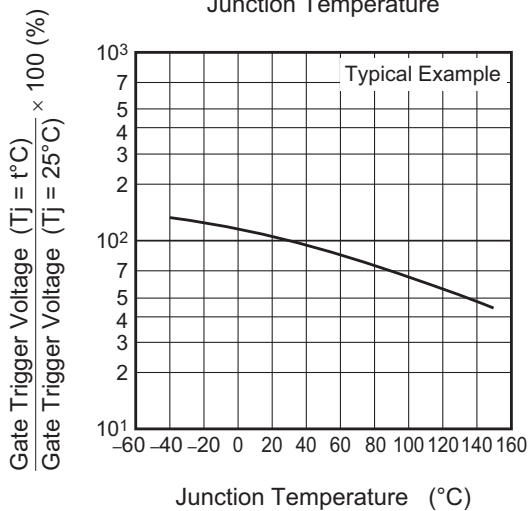

Maximum Transient Thermal Impedance Characteristics (Junction to case)

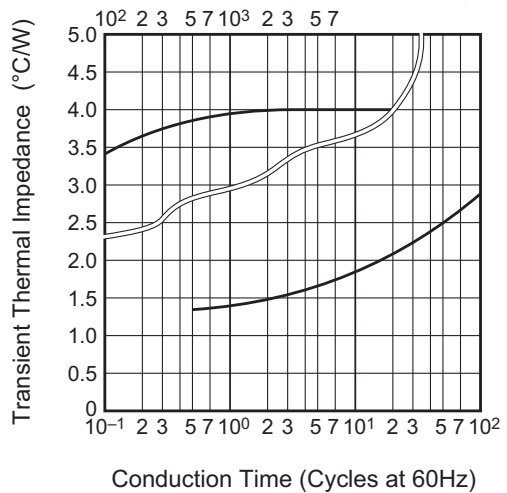

Maximum Transient Thermal Impedance Characteristics (Junction to ambient)

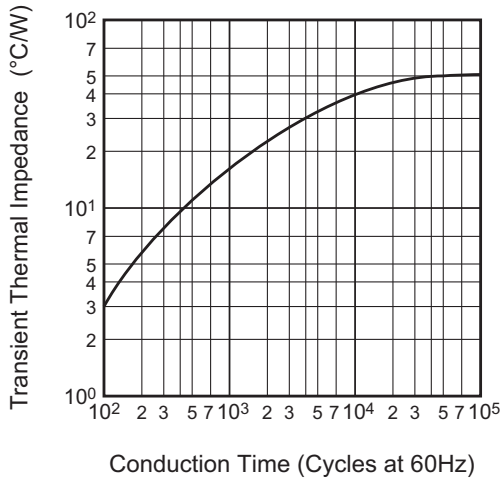

Maximum On-State Power Dissipation

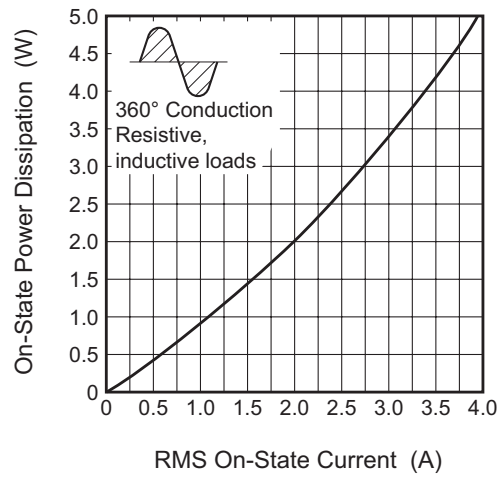

Allowable Case Temperature vs. RMS On-State Current

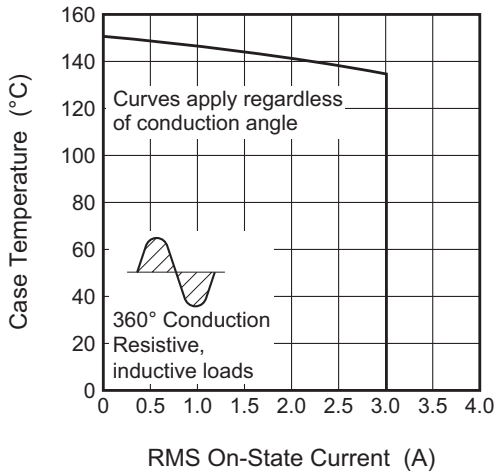

Allowable Ambient Temperature vs. RMS On-State Current

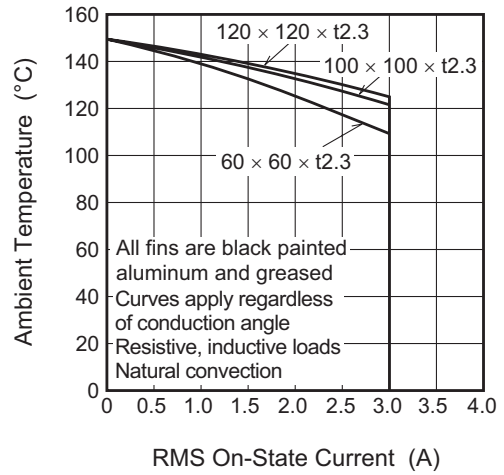

Allowable Ambient Temperature vs. RMS On-State Current

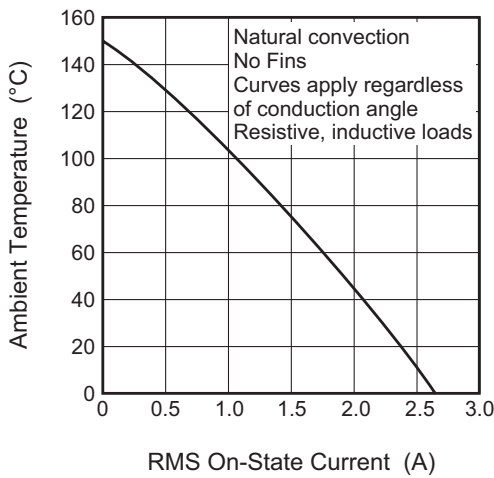

Repetitive Peak Off-State Current vs. Junction Temperature

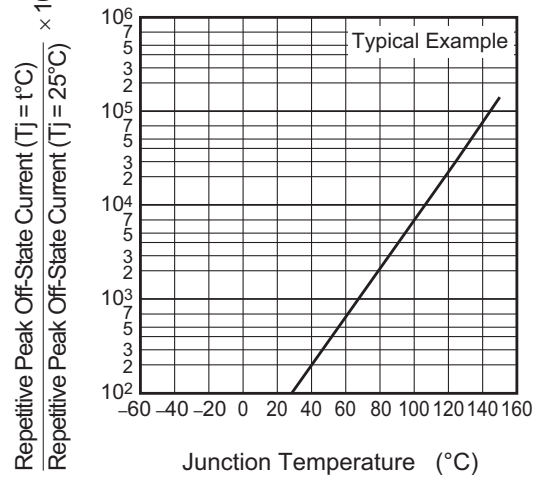

Holding Current vs. Junction Temperature

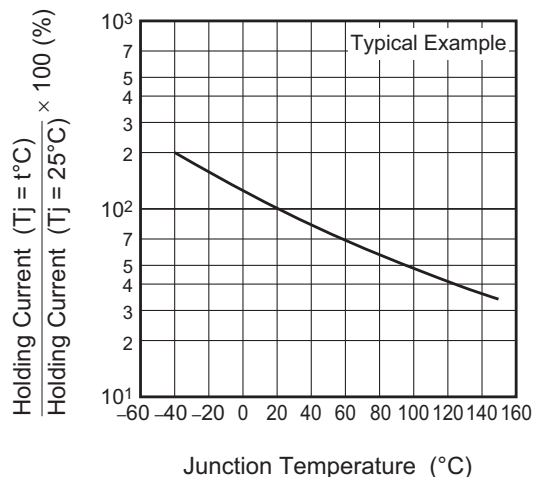

Latching Current vs. Junction Temperature

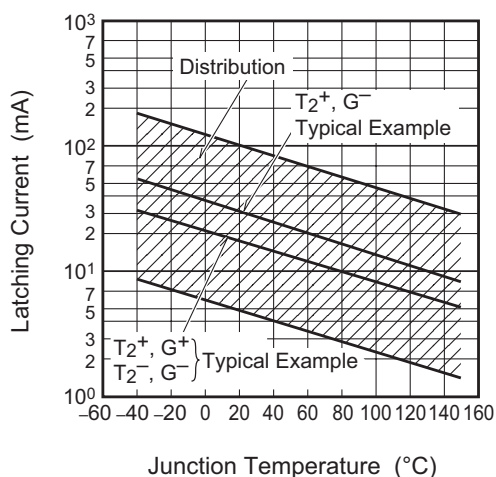

Breakover Voltage vs. Junction Temperature

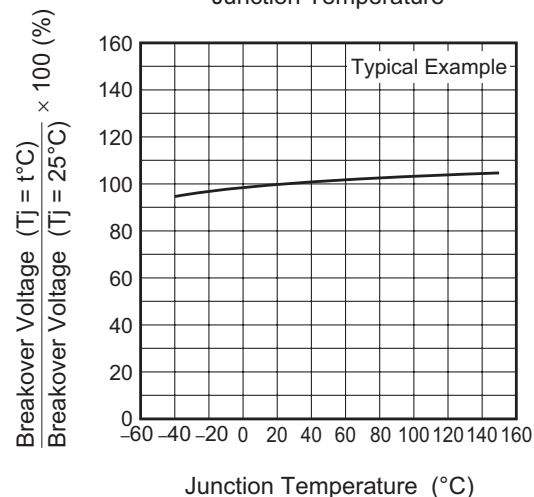

Breakover Voltage vs. Rate of Rise of Off-State Voltage (Tj=125°C)

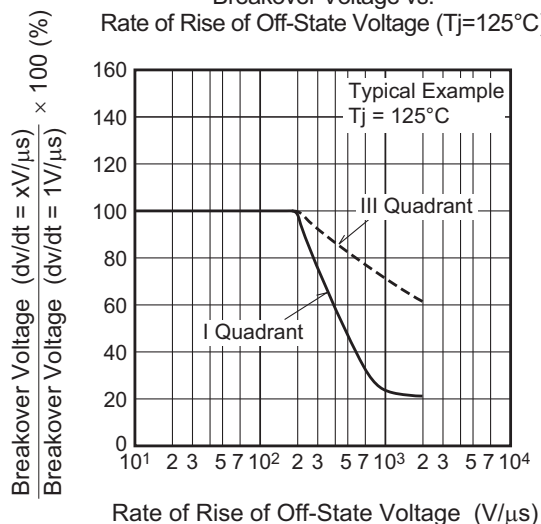

Breakover Voltage vs. Rate of Rise of Off-State Voltage (Tj=150°C)

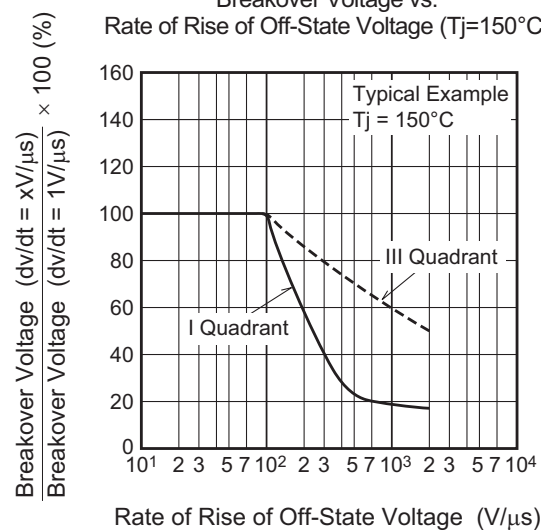

Gate Trigger Current vs. Gate Current Pulse Width

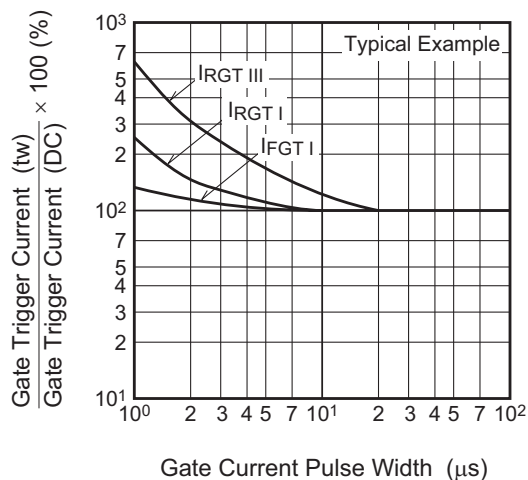

Gate Trigger Characteristics Test Circuits

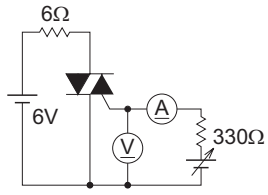

Test Procedure I

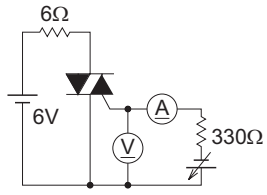

Test Procedure II

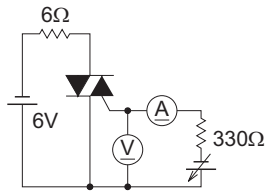

Test Procedure III

Recommended Circuit Values Around The Triac

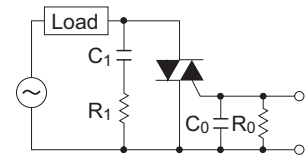

$C_1 = 0.1 \text{ to } 0.47 \mu\text{F}$ $C_0 = 0.1 \mu\text{F}$
 $R_1 = 47 \text{ to } 100 \Omega$ $R_0 = 100 \Omega$

TO-220FN

EIAJ Package Code	JEDEC Code	Mass (g) (reference value)	Lead Material
—	—	2.0	Cu alloy

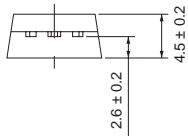
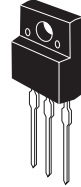
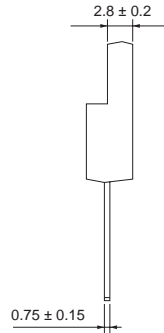
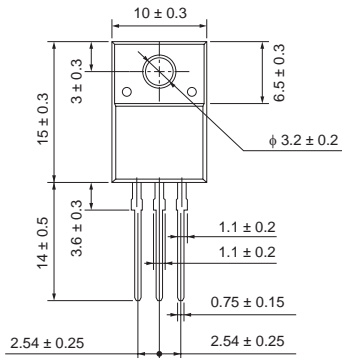

Note 1) The dimensional figures indicate representative values unless otherwise the tolerance is specified.

Symbol	Dimension in Millimeters		
	Min	Typ	Max
A	—	—	—
A ₁	—	—	—
A ₂	—	—	—
b	—	—	—
D	—	—	—
E	—	—	—
e	—	—	—
x	—	—	—
y	—	—	—
y ₁	—	—	—
ZD	—	—	—
ZE	—	—	—

Order Code

Lead form	Standard packing	Quantity	Standard order code	Standard order code example
Straight type	Plastic Magazine (Tube)	50	Type name +RB	BCR3KM-12RB
Lead form	Plastic Magazine (Tube)	50	Type name +RB – Lead forming code	BCR3KM-12RB-A8

Note : Please confirm the specification about the shipping in detail.