

3NT | SERIES

FIXED TEMPERATURE THERMOSTATS

Introduction

Automatic reset thermostat designed to meet your specific application requirements. Its patented and tamper proof snap action bi-metal disc provides reliable and repeatable switch actuation. The 3NT is suitable for electrical loads ranging from dry circuits to 10A @ 240 VAC.

The core of the 3NT is the proven 1NT thermostat. Recognized by UL/CSA and KEMA/ENEC agencies, hundreds of millions of the 1NT device are in the field today used in a variety of HVAC, appliance, automotive and specialty applications.

Manufactured at ISO 9001 certified manufacturing sites, its dry seal allows direct integration of the thermostat into a wire harness eliminating the need for extra connections.



Features

- Automatic reset
- Small and easy to mount
- Fast thermal response
- Innovative dry seal design - protects from moisture and dust
- Reliable 100K cycle life
- High temperature - to 275°F (135°C)

Applications

- HVAC
- Commercial
- Dehumidifiers
- Freezers
- Heat pumps
- Ice makers
- Refrigerators
- Condensing or moist environments

SPECIFICATIONS

Electrical Ratings	Agency	Cycles x1000	Volts	FLA	LRA	Amps (resistive)	VA
	UL (USA, Canada)	100	120 Vac	5.8	34.8	10	125
	100	240 Vac	2.9	17.4	10	125	
	30	120 Vac	10.0	40.0			
	30	240 Vac	10.0	40.0			
	100	30 Vdc			1		
ENEC (Europe)	30	240 Vac			16		
Operating Temperature	-20 to 135°C (-4 to 275°F)						
Ambient Temperature	-40°C to maximum wire lead insulation						
Temperature rating	PVC - 105°C XLP - 125°C (Allow 15°C de-rating below wire insulation rating at maximum 10A current)						
Minimum Nominal Temperature Differential	8°C (15°F)						
Dielectric Strength	750 Vrms 1500 Vrms terminals to case						
Standard Wire Leads	18 AWG (1/32" or 1/16" wall thickness in either 105°C PVC or 125°C XLPE) 16 AWG (1/32" wall thickness in 105°C PVC)						



3NT DRY SEAL DESIGN



Important Notice: The 3NT is not hermetically sealed, and should not be submerged in liquid. For such applications, please contact Sensata.



STANDARD TEMPERATURES AND TOLERANCES

Nominal Top Temperature		Nominal Differential		Open Temperature		Close Temperature	
°F	°C	°F	°C	°F	°C	°F	°C
32 to 80	0 to 27	20 - 29	11 - 16	±5.5	±3	±7.5	±4
		30 - 38	17 - 21	±5.5	±3	±8.5	±4.5
		39 - 60	22 - 33	±5.5	±3	±10	±5.5
81 to 167	28 to 75	20 - 23	11 - 13	±5.5	±3	±7.5	±4
		24 - 29	14 - 16	±5.5	±3	±8.5	±4.5
		30 - 59	17 - 33	±5.5	±3	±10	±5.5
168 to 199 ⁽¹⁾	76 to 93 ⁽¹⁾	20 - 23	11 - 13	±5.5	±3	±7.5	±4
		24 - 29	14 - 16	±5.5	±3	±8.5	±4.5
		30 - 59	17 - 33	±5.5	±3	±9	±5
200 to 249 ⁽¹⁾	94 to 121 ⁽¹⁾	20 - 29	11 - 16	±6.5	±3.5	±8.5	±4.5
		30 - 38	17 - 21	±6.5	±3.5	±10	±5.5
		39 - 59	22 - 33	±6.5	±3.5	±12	±6.5
		60 - 99	34 - 55	±10	±5.5	±20	±11
250 to 275	122 to 135	24 - 38	14 - 21	±7.5	±4	±10	±5.5
		39 - 59	22 - 33	±7.5	±4	±14.5	±8
		60 - 99	34 - 55	±10	±5.5	±20	±11

⁽¹⁾ Minimum bottom temperature of 50°C (122°F)



TYPICAL PHYSICAL CHARACTERISTICS

Dimensions in mm (inches)

Basic 3NT Dimensions



Surface Mount Clip



Locking Tube Mount Clip (3/8 Inch Shown)



Open Tube Mount Clip (3/8 Inch Shown at 90° CCW Rotation) 90° and 180° CW Rotations Available

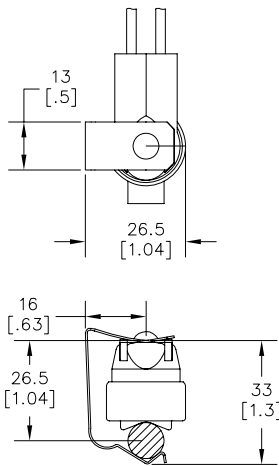

Snap Tube Mount Clip For 5/8 Inch and 1/2 Inch Tubes

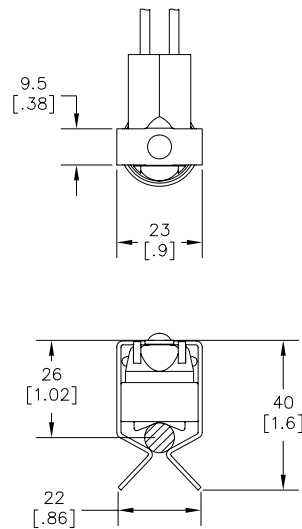

Additional Clips Available for [1/4], [5/16], [1/2], [5/8] t tubes

Additional Clips Available for [1/4], [5/16], [1/2], [5/8] tubes

Additional Clips Available for [3/4], [7/8] tubes



ORDERING OPTIONS

Part Number

	3NT	01	L	H	XXXX
Family					
3NT					
Contact Material					
01: Silver					
11: Gold <12V or <100 mA					
Switch Opening Logic					
L: On Temp. Rise					
F: On Temp. fall					
Dry Seal Construction					
H: High Temp. (Silicon rubber)					
N: No leads					
ID Number					
-Temperature Code	-Specifications				
-Wire Leads	-Terminals and Mounting Clip				

Temperature Code

	L	50	F	30
Operating Temperature				
L: Limit				
F: Fan				
Operating Temperature				
Nominal Opening				
Temperature				
Temp. Code				
C: Celsius				
F: Fahrenheit				
Differential				
Difference between Nominal Open and				
Nominal Close Temperature				



AGENCY APPROVALS & CERTIFICATIONS

	File/Report Number	Category
UL (USA) ⁽²⁾	SA995	Category SDFY2
UL (CANADA) ⁽²⁾	SA995	Category SDFY8
DEKRA (ENEC)	2014531.16	EN60730-1, EN60730-2-9
DEKRA (IECEX)	21862646400	IEC60079-0, IEC60079-15 IEC60529

⁽²⁾ Recognized to US and Canadian requirements by Underwriters Laboratories (UL873 and C22.2 No. 24)

IMPORTANT NOTICE

These devices may not be used as service components, strictly for use by Original Equipment Manufacturer, not repair. **USERS ARE SOLELY RESPONSIBLE** for design application and function of the end use product. Users must evaluate the suitability of these devices to their application with respect to temperature settings, mechanical cycle life, electrical loading and environmental conditions. This product is not hermetically sealed, it should not be submerged in any liquid. This product is not rated as explosion proof and should not be applied in any application where flammable vapors, gases or dust may be present. End of life failure of this device may result in either open or closed circuit condition. Suitable "End of life" protection should be applied in series with this device per safety agency specifications.



WARNINGS



RISK OF MATERIAL DAMAGE AND HOT ENCLOSURE

- The product's side panels may be hot, allow the product to cool before touching
- Follow proper mounting instructions including torque values
- Do not allow liquids or foreign objects to enter this product

Failure to follow these instructions can result in serious injury, or equipment damage.



HAZARD OF ELECTRIC SHOCK, EXPLOSION OR ARCH FLASH

- Disconnect all power before installing or working with this equipment
- Verify all connections and replace all covers before turning on power

Failure to follow these instructions will result in death or serious injury

Sensata Technologies, Inc. ("Sensata") data sheets are solely intended to assist designers ("Buyers") who are developing systems that incorporate Sensata products (also referred to herein as "components"). Buyer understands and agrees that Buyer remains responsible for using its independent analysis, evaluation and judgment in designing Buyer's systems and products. Sensata data sheets have been created using standard laboratory conditions and engineering practices. Sensata has not conducted any testing other than that specifically described in the published documentation for a particular data sheet. Sensata may make corrections, enhancements, improvements and other changes to its data sheets or components without notice.

Buyers are authorized to use Sensata data sheets with the Sensata component(s) identified in each particular data sheet. HOWEVER, NO OTHER LICENSE, EXPRESS OR IMPLIED, BY ESTOPPEL OR OTHERWISE TO ANY OTHER SENSATA INTELLECTUAL PROPERTY RIGHT, AND NO LICENSE TO ANY THIRD PARTY TECHNOLOGY OR INTELLECTUAL PROPERTY RIGHT, IS GRANTED HEREIN. SENSATA DATA SHEETS ARE PROVIDED "AS IS". SENSATA MAKES NO WARRANTIES OR REPRESENTATIONS WITH REGARD TO THE DATA SHEETS OR USE OF THE DATA SHEETS, EXPRESS, IMPLIED OR STATUTORY, INCLUDING ACCURACY OR COMPLETENESS. SENSATA DISCLAIMS ANY WARRANTY OF TITLE AND ANY IMPLIED WARRANTIES OF MERCHANTABILITY, FITNESS FOR A PARTICULAR PURPOSE, QUIET ENJOYMENT, QUIET POSSESSION, AND NON-INFRINGEMENT OF ANY THIRD PARTY INTELLECTUAL PROPERTY RIGHTS WITH REGARD TO SENSATA DATA SHEETS OR USE THEREOF.

All products are sold subject to Sensata's terms and conditions of sale supplied at www.sensata.com SENSATA ASSUMES NO LIABILITY FOR APPLICATIONS ASSISTANCE OR THE DESIGN OF BUYERS' PRODUCTS. BUYER ACKNOWLEDGES AND AGREES THAT IT IS SOLELY RESPONSIBLE FOR COMPLIANCE WITH ALL LEGAL, REGULATORY AND SAFETY-RELATED REQUIREMENTS CONCERNING ITS PRODUCTS, AND ANY USE OF SENSATA COMPONENTS IN ITS APPLICATIONS, NOTWITHSTANDING ANY APPLICATIONS-RELATED INFORMATION OR SUPPORT THAT MAY BE PROVIDED BY SENSATA.

Mailing Address: Sensata Technologies, Inc., 529 Pleasant Street, Attleboro, MA 02703, USA.

CONTACT US

Americas

+1 (888) 438 2214
sensors@sensata.com

Europe, Middle East & Africa

+31 (74) 357 8156
temperature-info.eu@sensata.com

Asia Pacific

sales.isasia@list.sensata.com
China +86 (21) 2306 1500
Japan +81 (45) 277 7117
Korea +82-10-9218-1179
India +91 (80) 67920890
Rest of Asia +886 (2) 27602006
ext 2808