

VOLTAGE RANGE: 2.4 - 75V
POWER: 0.3 Watts

Features

- Total power dissipation : max. 300 mW
- Small plastic package suitable for surface mount design
- High reliability

Mechanical Data

- Case: SOD-323, Molded Plastic
- Terminals: Plated Leads Solderable per MIL-STD-202, Method 208
- Polarity: Cathode Band
- Weight: 0.004 grams (approx.)

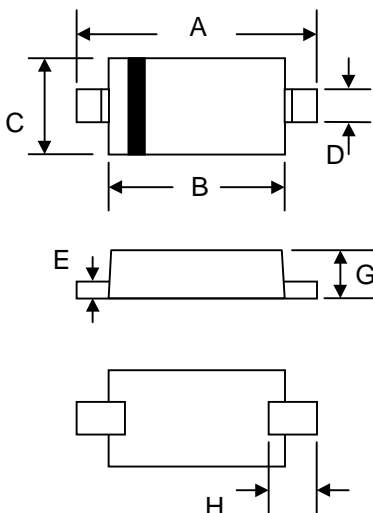
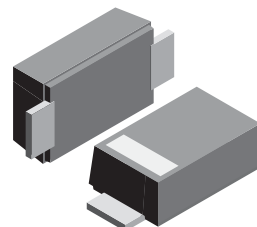

SOD-323		
Dim	Min	Max
A	2.30	2.70
B	1.75	1.95
C	1.15	1.35
D	0.25	0.35
E	0.05	0.15
G	0.70	0.95
H	0.30	—

All Dimensions in mm

Maximum Ratings T_A = 25°C unless otherwise specified

Parameter	Symbol	Value	Unit
Power Dissipation	P _D	300	mW
Forward Voltage at V _F = 10 mA	V _F	0.9	V
Thermal Resistance Junction to Ambient Air	R _{θJA}	0.3	K/mW
Junction Temperature Range	T _J	150	°C
Storage Temperature Range	T _{STG}	-55 to + 150	°C

Electrical Characteristics T_A=25°C unless otherwise noted

Device Type	V _Z (V) @ I _{ZT}			Z _{ZT} (Ω) @ I _{ZT}	I _{ZT} (mA)	Z _{ZK} (Ω) @ I _{ZK}	I _{ZK} (mA)	I _R (μA) @ V _R	V _R (V)
	Min.	Typ.	Max.	Max.	-	Max.	-	Max	-
MM3Z2V4B	2.35	2.4	2.45	94	5	564	1	45	1
MM3Z2V7B	2.65	2.7	2.75	94	5	564	1	18	1
MM3Z3V0B	2.94	3.0	3.06	89	5	564	1	9	1
MM3Z3V3B	3.23	3.3	3.37	89	5	564	1	4.5	1
MM3Z3V6B	3.53	3.6	3.67	84	5	564	1	4.5	1
MM3Z3V9B	3.82	3.9	3.98	84	5	564	1	2.7	1
MM3Z4V3B	4.21	4.3	4.39	84	5	564	1	2.7	1
MM3Z4V7B	4.61	4.7	4.79	75	5	470	1	2.7	2
MM3Z5V1B	5.00	5.1	5.20	56	5	451	1	1.8	2
MM3Z5V6B	5.49	5.6	5.71	37	5	376	1	0.9	2
MM3Z6V2B	6.08	6.2	6.32	9	5	141	1	2.7	4
MM3Z6V8B	6.66	6.8	6.94	14	5	75	1	1.8	4
MM3Z7V5B	7.35	7.5	7.65	14	5	75	1	0.9	5
MM3Z8V2B	8.04	8.2	8.36	14	5	75	1	0.63	5
MM3Z9V1B	8.92	9.1	9.28	14	5	94	1	0.45	6
MM3Z10VB	9.80	10	10.20	18	5	141	1	0.18	7
MM3Z11VB	10.78	11	11.22	18	5	141	1	0.09	8
MM3Z12VB	11.76	12	12.24	23	5	141	1	0.09	8
MM3Z13VB	12.74	13	13.26	28	5	160	1	0.09	8
MM3Z15VB	14.70	15	15.30	28	5	188	1	0.045	10.5
MM3Z16VB	15.68	16	16.32	37	5	188	1	0.045	11.2
MM3Z18VB	17.64	18	18.36	42	5	212	1	0.045	12.6
MM3Z20VB	19.60	20	20.40	51	5	212	1	0.045	14.0
MM3Z22VB	21.56	22	22.44	51	5	235	1	0.045	15.4
MM3Z24VB	23.52	24	24.48	65	5	235	1	0.045	16.8
MM3Z27VB	26.46	27	27.54	75	5	282	0.5	0.045	18.9
MM3Z30VB	29.40	30	30.60	75	5	282	0.5	0.045	21.0
MM3Z33VB	32.34	33	33.66	75	5	306	0.5	0.045	23.0
MM3Z36VB	35.28	36	36.72	84	5	329	0.5	0.045	25.2
MM3Z39VB	38.22	39	39.78	122	5	329	0.5	0.045	27.3
MM3Z43VB	42.14	43	43.86	141	5	353	0.5	0.045	30.1
MM3Z47VB	46.06	47	47.94	160	5	353	0.5	0.045	33.0
MM3Z51VB	49.98	51	52.02	169	5	376	0.5	0.045	35.7
MM3Z56VB	54.88	56	57.12	188	5	400	0.5	0.045	39.2
MM3Z62VB	60.76	62	63.24	202	5	423	0.5	0.045	43.4
MM3Z68VB	66.64	68	69.36	226	5	447	0.5	0.045	47.6
MM3Z75VB	73.5	75	76.50	240	5	470	0.5	0.045	52.5

Notes :

1. The Zener Voltage (V_Z) is tested under pulse condition of 10mS.
2. The device numbers listed have a standard tolerance on the nominal zener voltage of ±2%.
3. The zener impedance is derived from the 60-cycle ac voltage, which results when an ac current having an rms value equal to 10% of the dc zener current (I_{ZT} or I_{ZK}) is superimposed to I_{ZT} or I_{ZK}.

Figure 1. Zener current vs. Zener Voltage

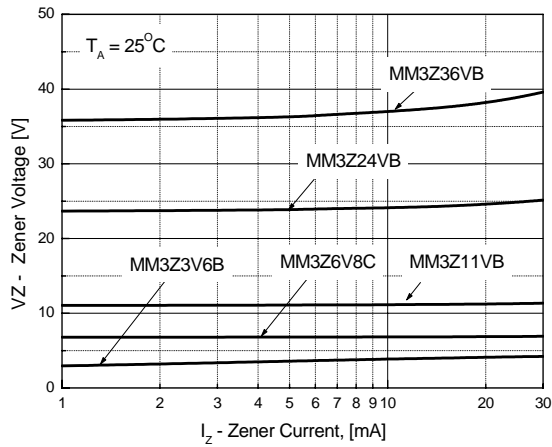
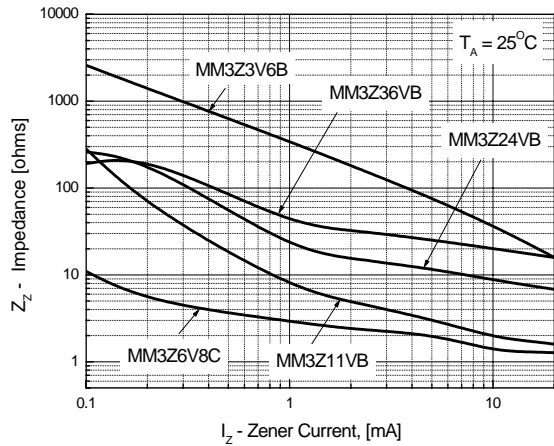
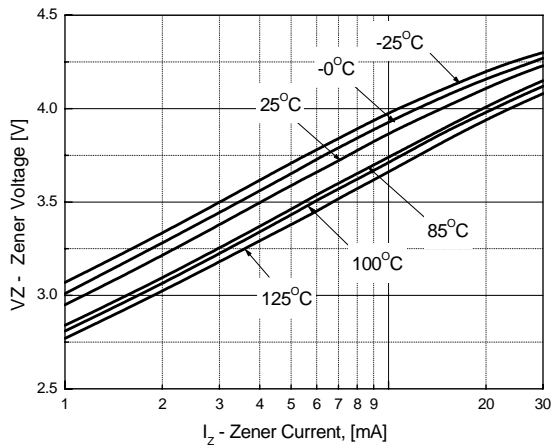

Figure 2. Zener current vs. Zener Impedance



**Figure 3. MM3Z3V6B
Zener current vs. Zener Voltage**



**Figure 4. MM3Z6V8C
Zener current vs. Zener Voltage**

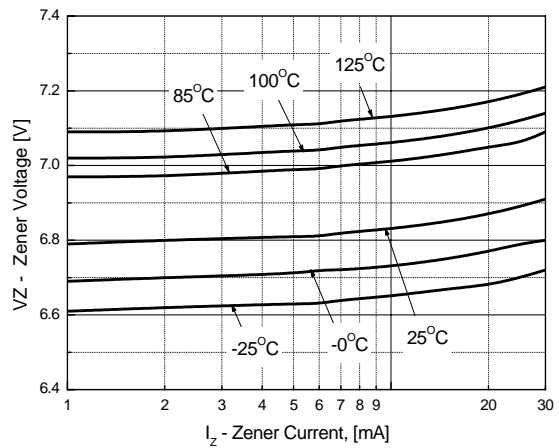

**Figure 5. MM3Z11VB
Zener current vs. Zener Voltage**

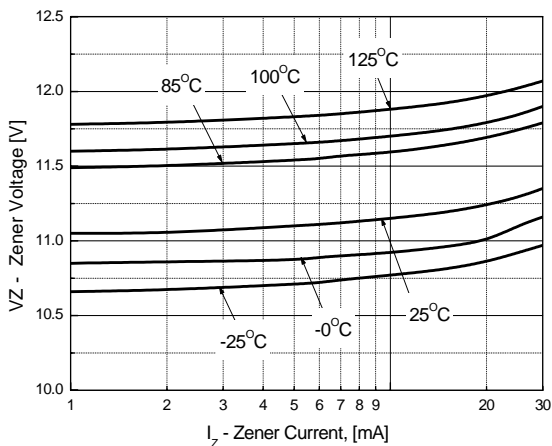

**Figure 6. MM3Z24VB
Zener current vs. Zener Voltage**

