



DATA SHEET

SEMICONDUCTOR

MUN221 Series

Bias Resistor Transistor



NPN Silicon Surface Mount Transistor with Monolithic Bias Resistor Network

This new series of digital transistors is designed to replace a single device and its external resistor bias network. The BRT (Bias Resistor Transistor) contains a single transistor with a monolithic bias network

resistor. The BRT eliminates these individual components by integrating them into a single device. The use of a BRT can reduce both system cost and board space. The device is housed in the SOT-23 package which is designed for low power surface mount applications.

- Simplifies Circuit Design
- Reduces Board Space and Component Count
- The SOT-23 package can be soldered using wave or reflow. The modified gull-winged leads absorb thermal stress during soldering eliminating the possibility of damage to the die.

SOT-23 (TO-236AB)

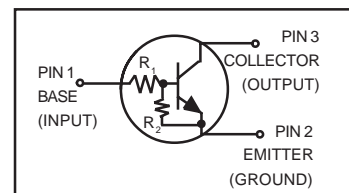
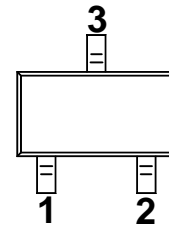

MAXIMUM RATINGS (T_A = 25°C unless otherwise noted)

Rating	Symbol	Value	Unit
Collector-Base Voltage	V _{CBO}	50	Vdc
Collector-Emitter Voltage	V _{CEO}	50	Vdc
Collector Current	I _C	100	mAdc
Total Power Dissipation @ T _A = 25°C (Note 1.) Derate above 25°C	P _D	246 1.5	mW °C/W

DEVICE MARKING AND RESISTOR VALUES

Device	Marking	R1(K)	R2(K)	Packing	Packing
MUN2211	A8A	10	10	SOT-23	3000/Reel
MUN2212	A8B	22	22	SOT-23	3000/Reel
MUN2213	A8C	47	47	SOT-23	3000/Reel
MUN2214	A8D	10	47	SOT-23	3000/Reel
MUN2215	A8E	10	∞	SOT-23	3000/Reel
MUN2216	A8F	4.7	∞	SOT-23	3000/Reel
MUN2230	A8G	1.0	1.0	SOT-23	3000/Reel
MUN2231	A8H	2.2	2.2	SOT-23	3000/Reel
MUN2232	A8J	4.7	4.7	SOT-23	3000/Reel
MUN2233	A8K	4.7	47	SOT-23	3000/Reel
MUN2234	A8L	22	47	SOT-23	3000/Reel
MUN2235	A8M	2.2	47	SOT-23	3000/Reel
MUN2238	A8R	2.2	∞	SOT-23	3000/Reel
MUN2241	A8U	100	∞	SOT-23	3000/Reel

1. Device mounted on a FR-4 glass epoxy printed circuit board using the minimum recommended footprint.

MUN221 Series

THERMAL CHARACTERISTICS

Rating	Symbol	Value	Unit
Thermal Resistance – Junction-to-Ambient (Note 1.)	$R_{\theta JA}$	508	$^{\circ}\text{C}/\text{W}$
Operating and Storage Temperature Range	T_J, T_{stg}	-55 to +150	$^{\circ}\text{C}$
Maximum Temperature for Soldering Purposes, Time in Solder Bath	T_L	260 10	$^{\circ}\text{C}$ Sec

ELECTRICAL CHARACTERISTICS ($T_A = 25^{\circ}\text{C}$ unless otherwise noted)

Characteristic	Symbol	Min	Typ	Max	Unit
----------------	--------	-----	-----	-----	------

OFF CHARACTERISTICS

Collector-Base Cutoff Current ($V_{CB} = 50\text{ V}, I_E = 0$)	I_{CBO}	–	–	100	nAdc
Collector-Emitter Cutoff Current ($V_{CE} = 50\text{ V}, I_B = 0$)	I_{CEO}	–	–	500	nAdc
Emitter-Base Cutoff Current ($V_{EB} = 6.0\text{ V}, I_C = 0$)	I_{EBO}	–	–	0.5	mAdc
MUN2211		–	–	0.2	
MUN2212		–	–	0.1	
MUN2213		–	–	0.2	
MUN2214		–	–	0.9	
MUN2215		–	–	1.9	
MUN2216		–	–	4.3	
MUN2230		–	–	2.3	
MUN2231		–	–	1.5	
MUN2232		–	–	0.18	
MUN2233		–	–	0.13	
MUN2234		–	–	0.2	
MUN2235		–	–	4.0	
MUN2238		–	–	0.1	
MUN2241		–	–		
Collector-Base Breakdown Voltage ($I_C = 10\ \mu\text{A}, I_E = 0$)	$V_{(BR)CBO}$	50	–	–	Vdc
Collector-Emitter Breakdown Voltage (Note 2.), ($I_C = 2.0\text{ mA}, I_B = 0$)	$V_{(BR)CEO}$	50	–	–	Vdc

ON CHARACTERISTICS (Note 2.)

DC Current Gain ($V_{CE} = 10\text{ V}, I_C = 5.0\text{ mA}$)	h_{FE}	35	60	–	
MUN2211		60	100	–	
MUN2212		80	140	–	
MUN2213		80	140	–	
MUN2214		160	350	–	
MUN2215		160	350	–	
MUN2216		3.0	5.0	–	
MUN2230		8.0	15	–	
MUN2231		15	30	–	
MUN2232		80	200	–	
MUN2233		80	150	–	
MUN2234		80	140	–	
MUN2235		160	350	–	
MUN2238		160	350	–	
MUN2241					
Collector-Emitter Saturation Voltage ($I_C = 10\text{ mA}, I_B = 0.3\text{ mA}$) ($I_C = 10\text{ mA}, I_B = 5\text{ mA}$) ($I_C = 10\text{ mA}, I_B = 1\text{ mA}$)	$V_{CE(sat)}$	–	–	0.25	Vdc
MUN2230/MUN2231					
MUN2215/MUN2216					
MUN2232/MUN2233/MUN2234					
MUN2235/MUN2238					

2. Pulse Test: Pulse Width < 300 μs , Duty Cycle < 2.0%.

MUN221 Series

ELECTRICAL CHARACTERISTICS (T_A = 25°C unless otherwise noted) (Continued)

Characteristic	Symbol	Min	Typ	Max	Unit
ON CHARACTERISTICS (Note 3.)					
Output Voltage (on) (V _{CC} = 5.0 V, V _B = 2.5 V, R _L = 1.0 k Ω)	V _{OL}	–	–	0.2	Vdc
MUN2211		–	–	0.2	
MUN2212		–	–	0.2	
MUN2214		–	–	0.2	
MUN2215		–	–	0.2	
MUN2216		–	–	0.2	
MUN2230		–	–	0.2	
MUN2231		–	–	0.2	
MUN2232		–	–	0.2	
MUN2233		–	–	0.2	
MUN2234		–	–	0.2	
MUN2235		–	–	0.2	
MUN2238		–	–	0.2	
(V _{CC} = 5.0 V, V _B = 3.5 V, R _L = 1.0 k Ω)		–	–	0.2	
(V _{CC} = 5.0 V, V _B = 5.0 V, R _L = 1.0 k Ω)		–	–	0.2	
MUN2213		–	–	0.2	
MUN2241		–	–	0.2	
Output Voltage (off) (V _{CC} = 5.0 V, V _B = 0.5 V, R _L = 1.0 k Ω)	V _{OH}	4.9	–	–	Vdc
(V _{CC} = 5.0 V, V _B = 0.050 V, R _L = 1.0 k Ω)					
(V _{CC} = 5.0 V, V _B = 0.25 V, R _L = 1.0 k Ω)					
MUN2230					
MUN2215					
MUN2216					
MUN2233					
MUN2238					
Input Resistor	R ₁	7.0	10	13	kΩ
MUN2211		15.4	22	28.6	
MUN2212		32.9	47	61.1	
MUN2213		7.0	10	13	
MUN2214		7.0	10	13	
MUN2215		3.3	4.7	6.1	
MUN2216		0.7	1.0	1.3	
MUN2230		1.5	2.2	2.9	
MUN2231		3.3	4.7	6.1	
MUN2232		3.3	4.7	6.1	
MUN2233		15.4	22	28.6	
MUN2234		1.54	2.2	2.86	
MUN2235		1.54	2.2	2.88	
MUN2238		70	100	130	
MUN2241					
Resistor Ratio	R ₁ /R ₂	0.8	1.0	1.2	
MUN2211/MUN2212/MUN2213		0.17	0.21	0.25	
MUN2214		–	–	–	
MUN2215/MUN2216/MUN2238		–	–	–	
MUN2241		–	–	–	
MUN2230/MUN2231/MUN2232		0.8	1.0	1.2	
MUN2233		0.055	0.1	0.185	
MUN2234		0.38	0.47	0.56	
MUN2235		0.038	0.047	0.056	

3. Pulse Test: Pulse Width < 300 μs, Duty Cycle < 2.0%.

DEVICE CHARACTERISTICS

MUN221 Series

TYPICAL ELECTRICAL CHARACTERISTICS MUN2211

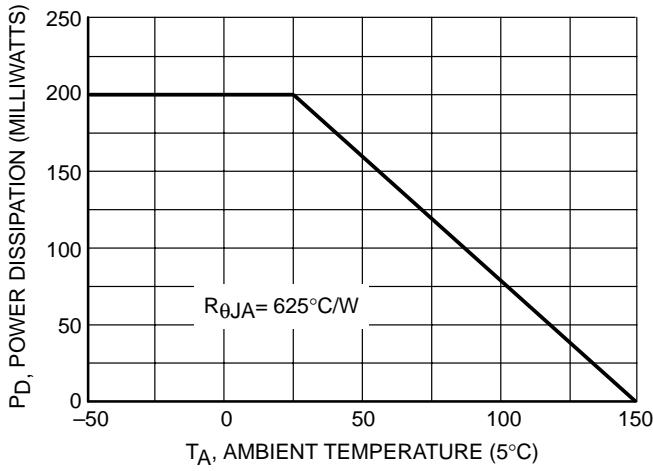

Figure 1. Derating Curve

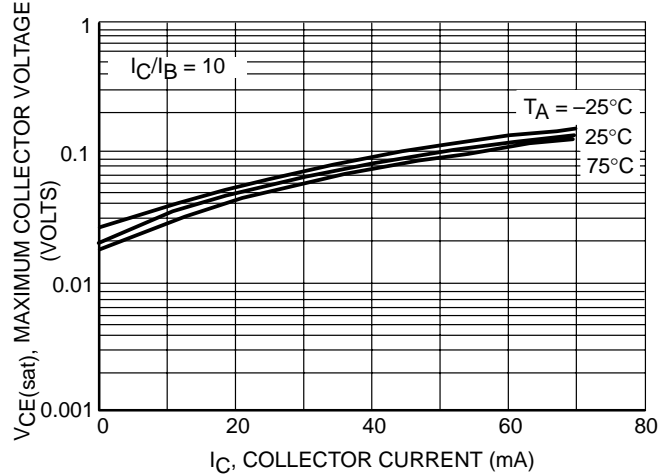

Figure 2. V_{CE(sat)} vs. I_C

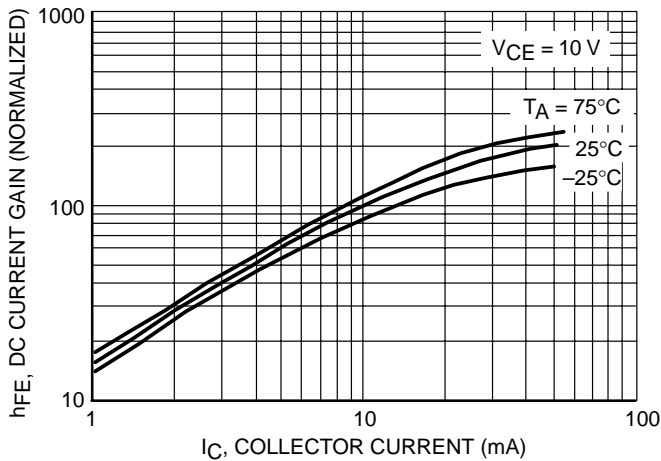

Figure 3. DC Current Gain

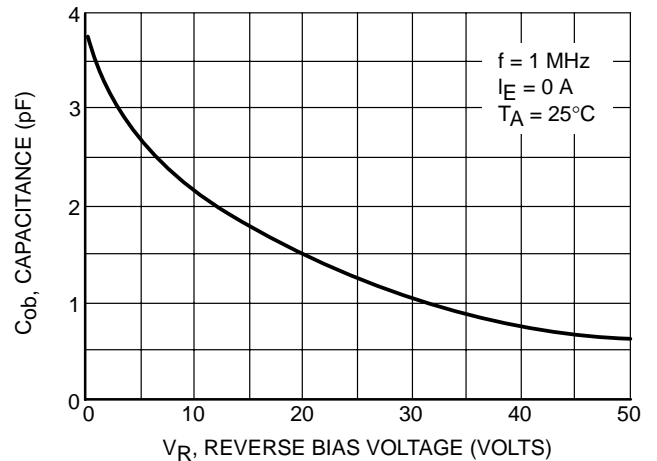

Figure 4. Output Capacitance

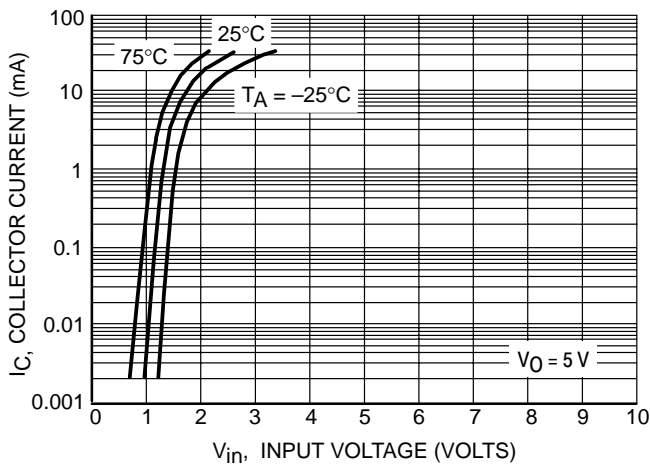

Figure 5. Output Current vs. Input Voltage

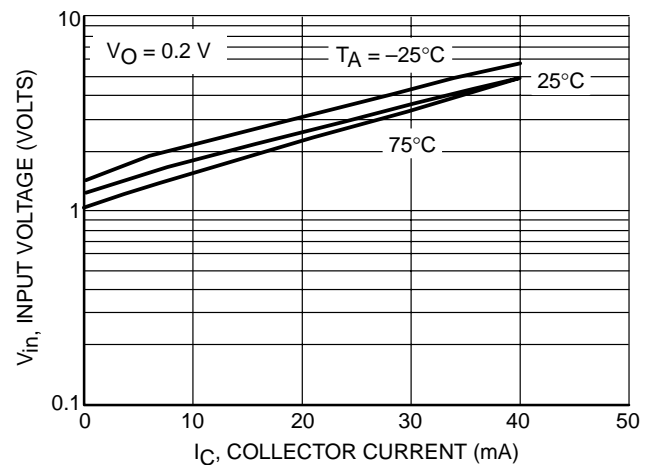

Figure 6. Input Voltage vs. Output Current

DEVICE CHARACTERISTICS

MUN221 Series

TYPICAL ELECTRICAL CHARACTERISTICS MUN2212

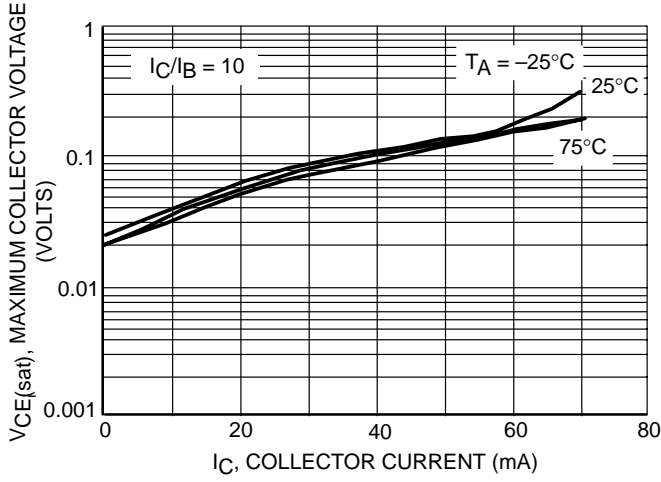

Figure 7. $V_{CE(sat)}$ vs. I_C

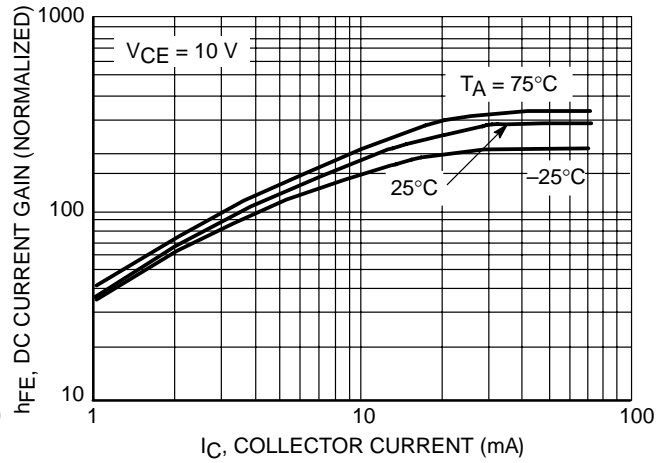

Figure 8. DC Current Gain

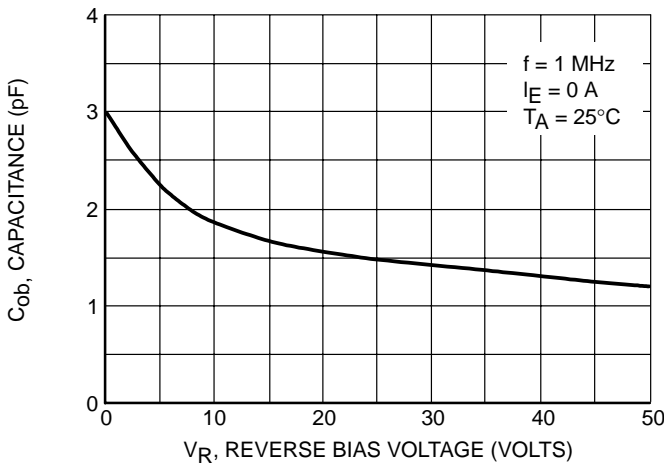

Figure 9. Output Capacitance

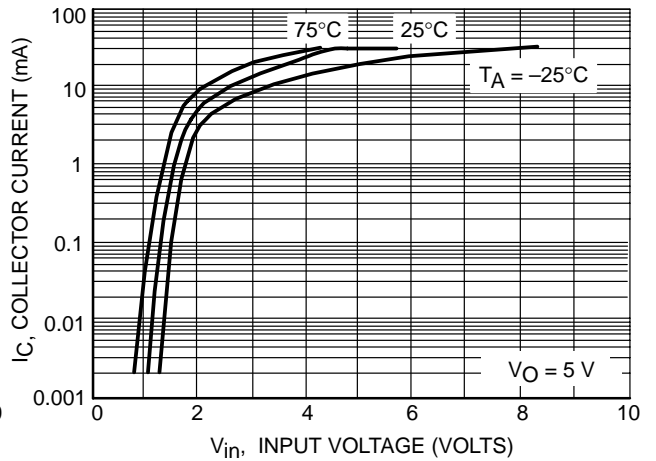

Figure 10. Output Current vs. Input Voltage

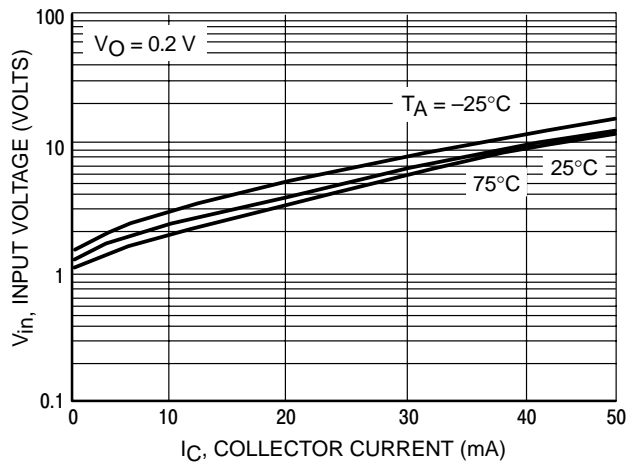

Figure 11. Input Voltage vs. Output Current

DEVICE CHARACTERISTICS

MUN221 Series

TYPICAL ELECTRICAL CHARACTERISTICS

MUN2213

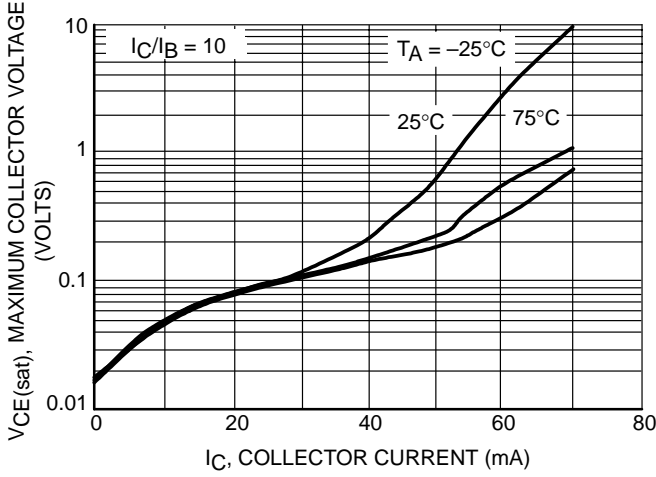

Figure 12. $V_{CE(sat)}$ vs. I_C

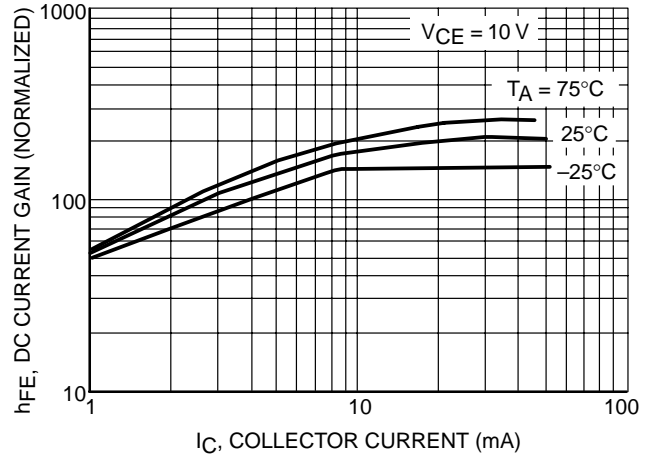

Figure 13. DC Current Gain

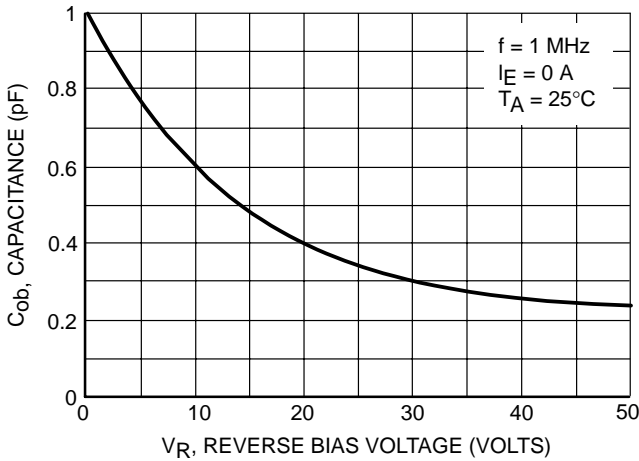

Figure 14. Output Capacitance

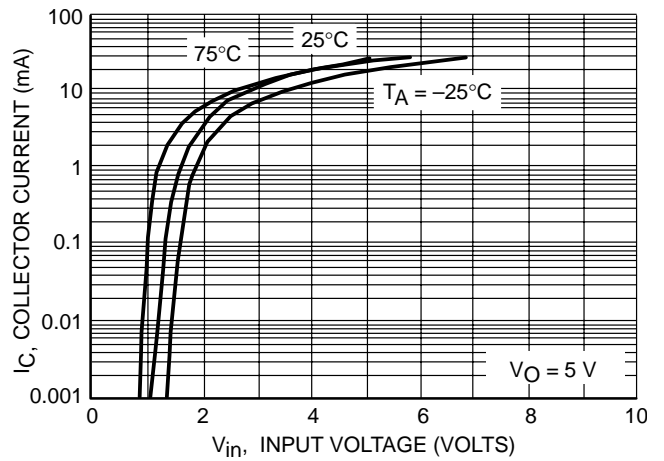

Figure 15. Output Current vs. Input Voltage

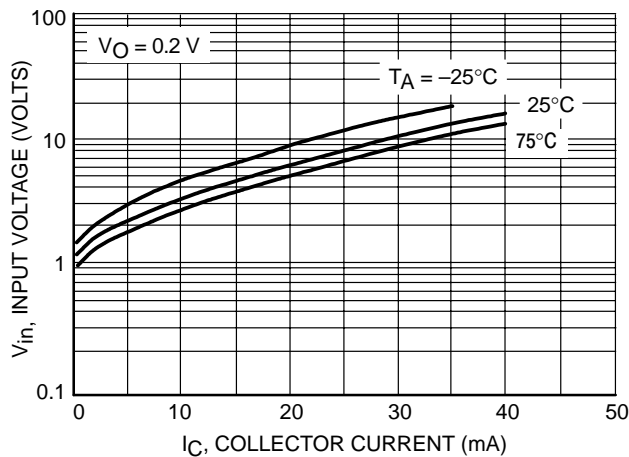

Figure 16. Input Voltage vs. Output Current

DEVICE CHARACTERISTICS

MUN221 Series

TYPICAL ELECTRICAL CHARACTERISTICS MUN2214

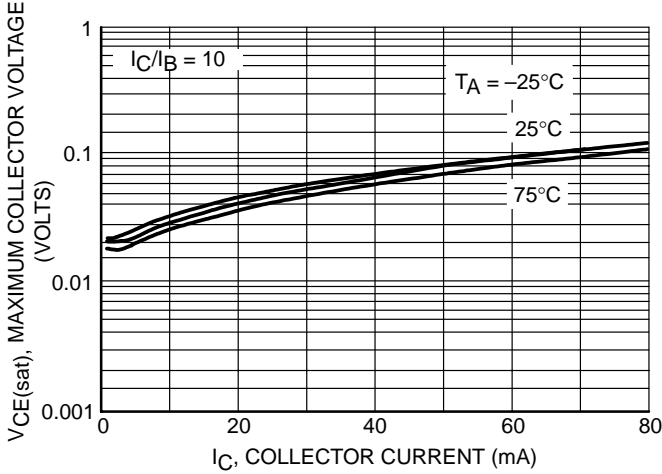

Figure 17. $V_{CE(sat)}$ vs. I_C

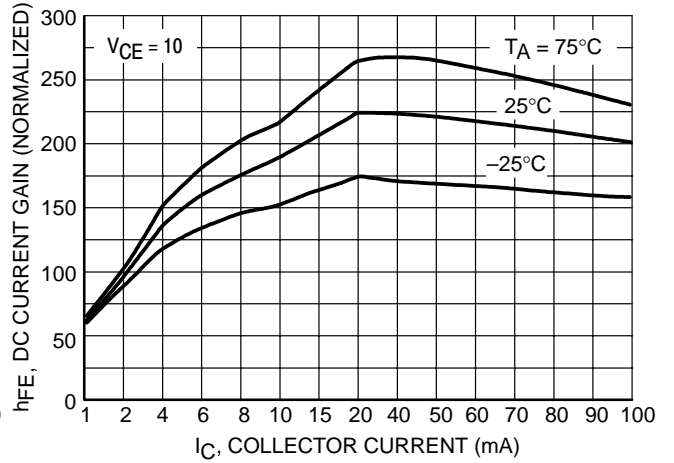

Figure 18. DC Current Gain

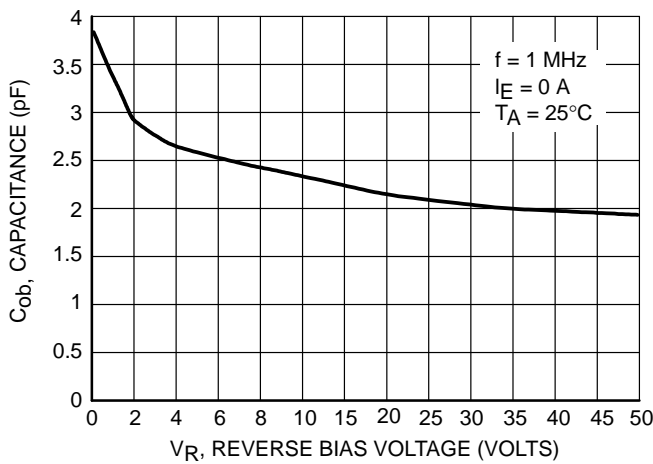

Figure 19. Output Capacitance

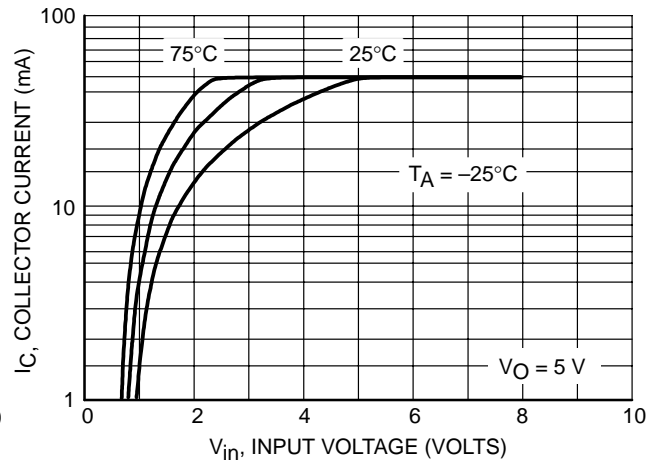

Figure 20. Output Current vs. Input Voltage

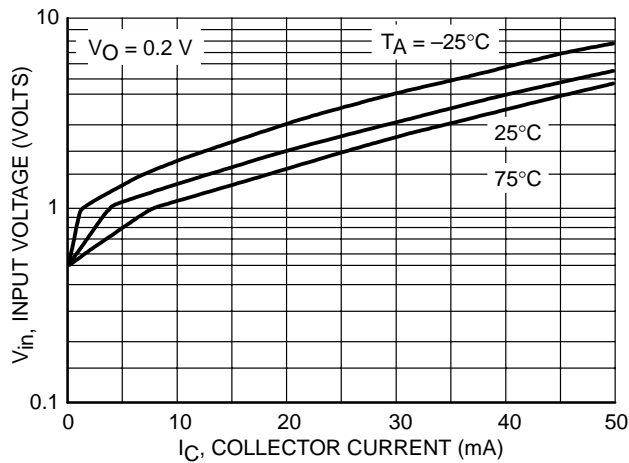

Figure 21. Input Voltage vs. Output Current

DEVICE CHARACTERISTICS

MUN221 Series

TYPICAL ELECTRICAL CHARACTERISTICS MUN2232

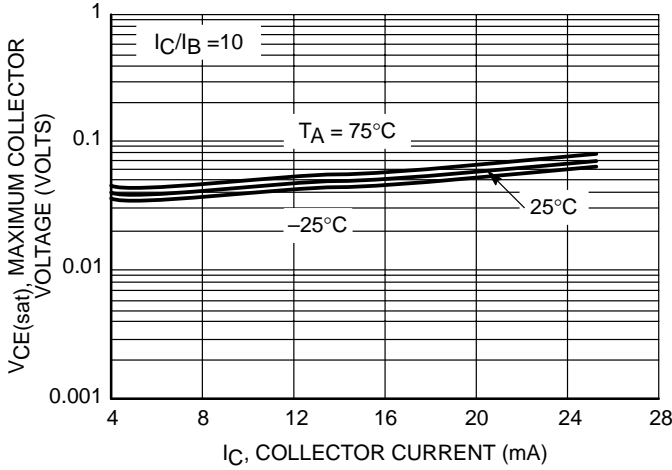

Figure 22. $V_{CE(sat)}$ vs. I_C

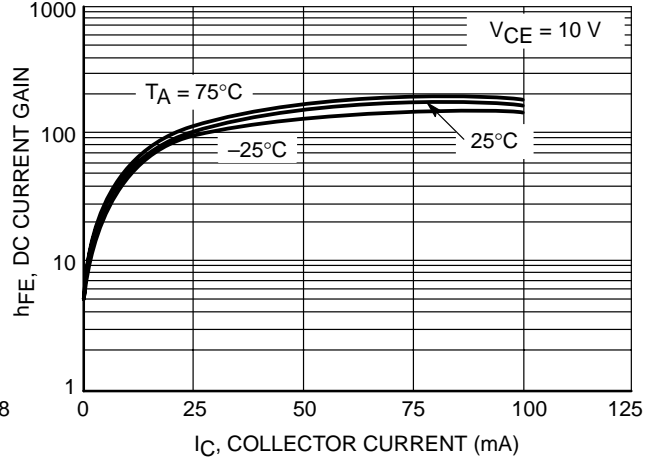

Figure 23. DC Current Gain

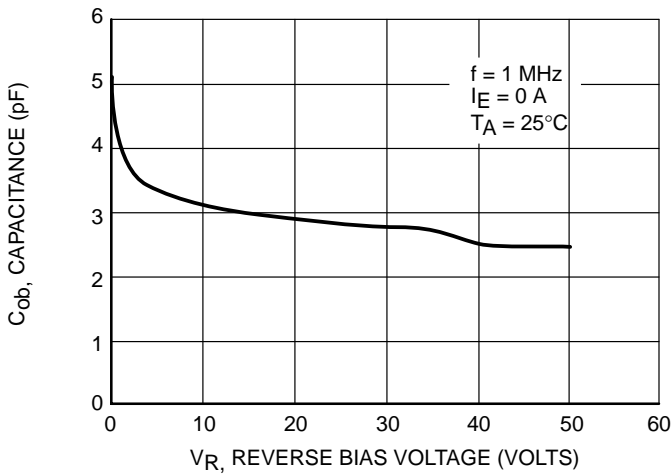

Figure 24. Output Capacitance

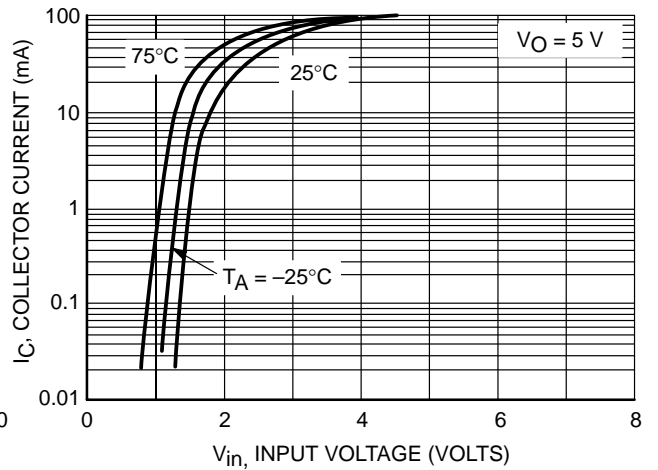

Figure 25. Output Current vs. Input Voltage

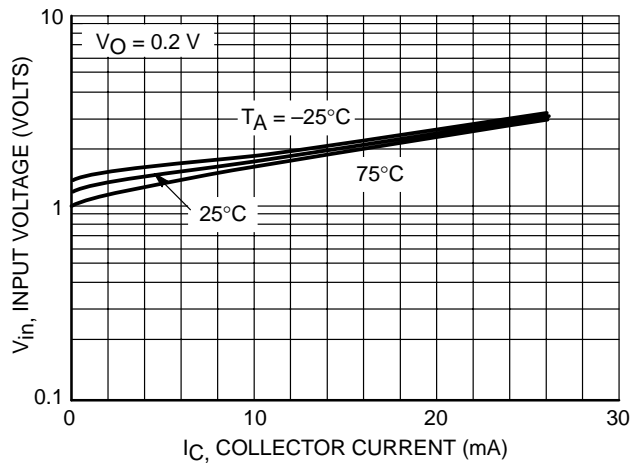

Figure 26. Output Voltage vs. Input Current

DEVICE CHARACTERISTICS

MUN221 Series

TYPICAL ELECTRICAL CHARACTERISTICS MUN2233

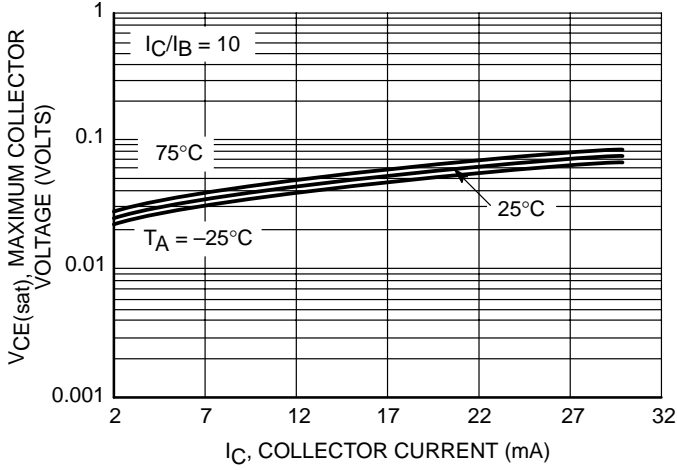

Figure 27. $V_{CE(sat)}$ vs. I_C

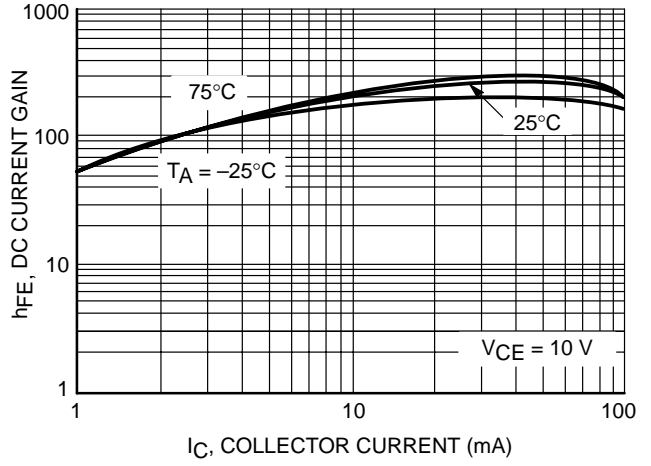

Figure 28. DC Current Gain

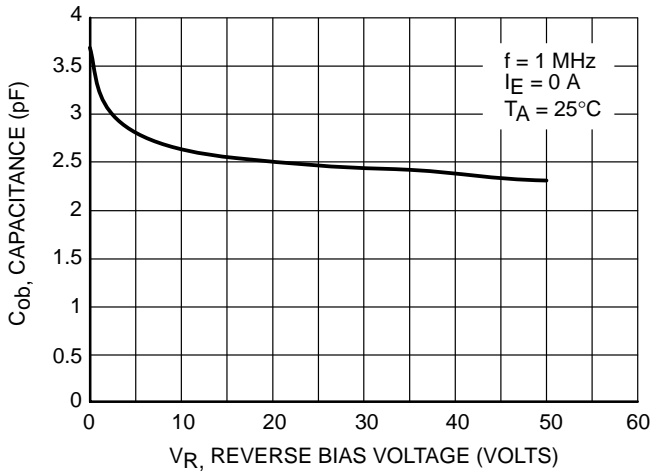

Figure 29. Output Capacitance

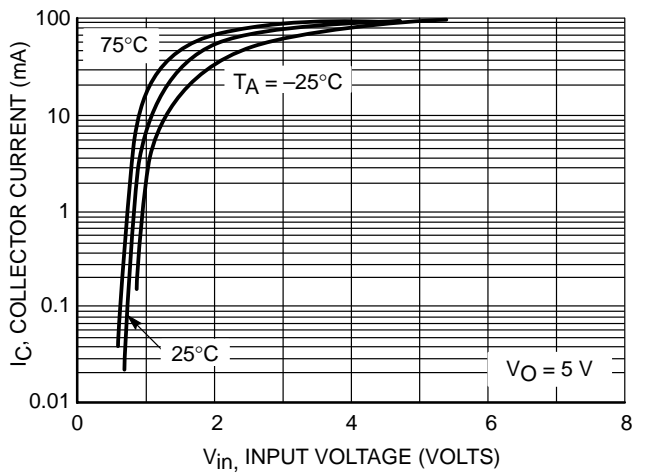

Figure 30. Output Current vs. Input Voltage

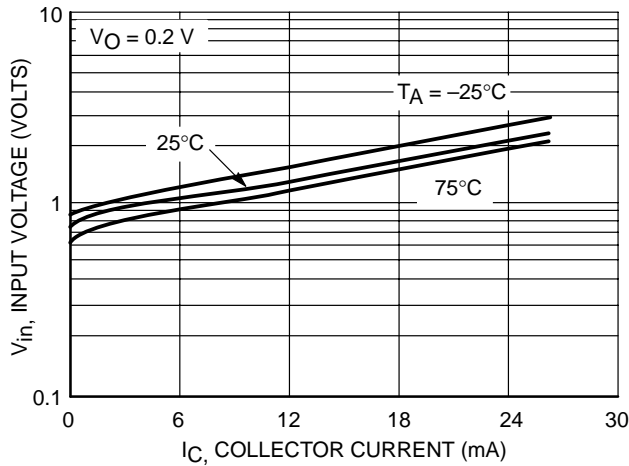

Figure 31. Input Voltage vs. Output Current

DEVICE CHARACTERISTICS

MUN221 Series

TYPICAL APPLICATIONS FOR NPN BRTs

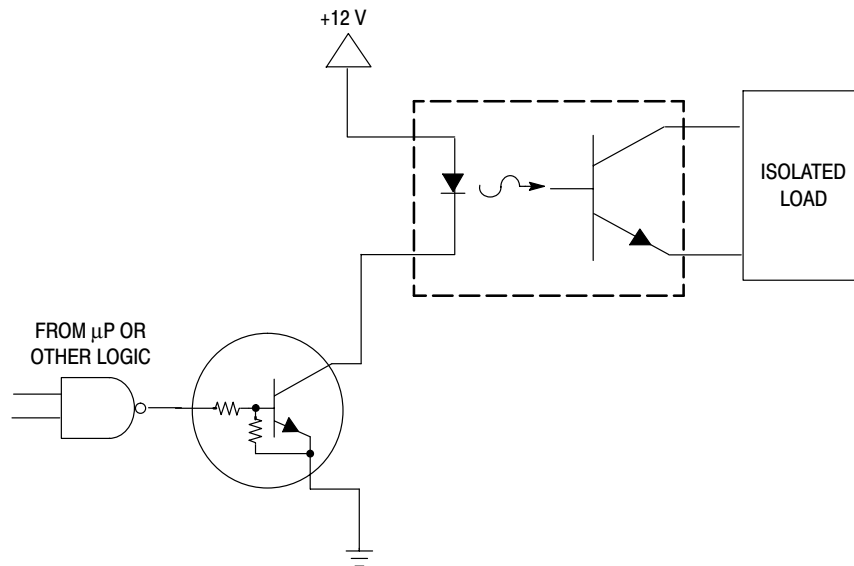

Figure 32. Level Shifter: Connects 12 or 24 Volt Circuits to Logic

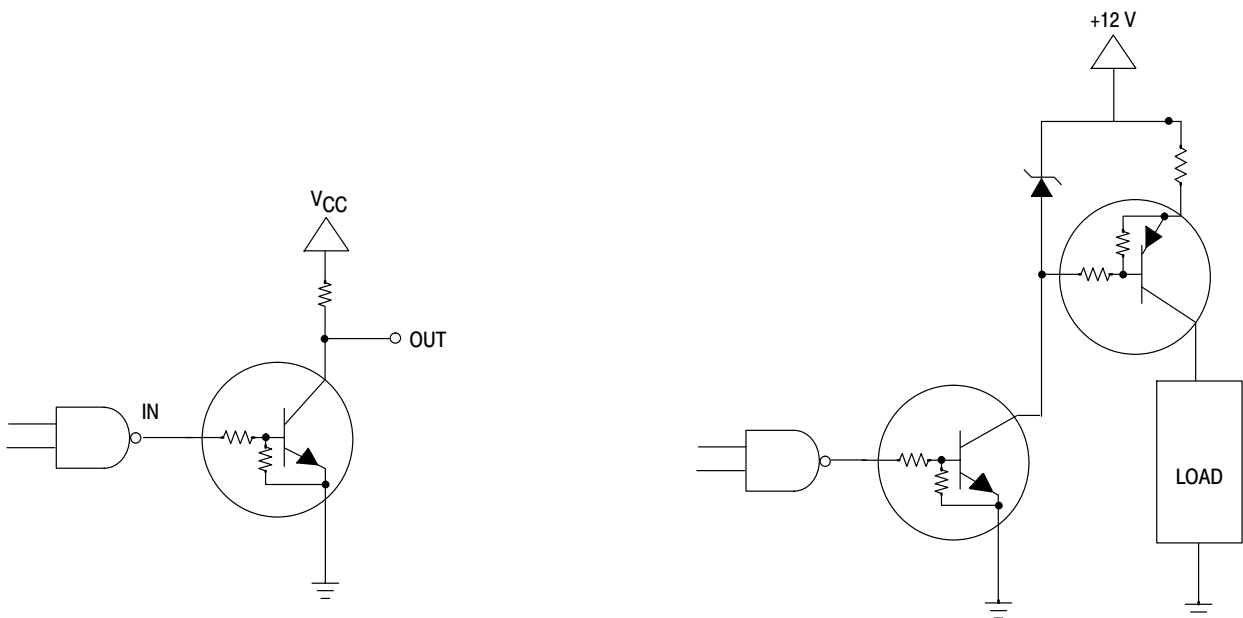

Figure 33. Open Collector Inverter: Inverts the Input Signal

Figure 34. Inexpensive, Unregulated Current Source

PACKAGE OUTLINE & DIMENSIONS

MUN221 Series

SOT-23

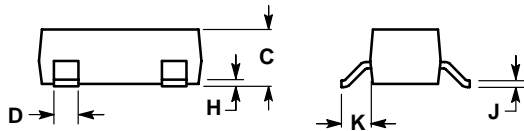
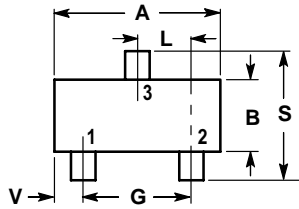

NOTES:

1. DIMENSIONING AND TOLERANCING PER ANSI Y14.5M, 1982.
2. CONTROLLING DIMENSION: INCH.

DIM	INCHES		MILLIMETERS	
	MIN	MAX	MIN	MAX
A	0.1102	0.1197	2.80	3.04
B	0.0472	0.0551	1.20	1.40
C	0.0350	0.0440	0.89	1.11
D	0.0150	0.0200	0.37	0.50
G	0.0701	0.0807	1.78	2.04
H	0.0005	0.0040	0.013	0.100
J	0.0034	0.0070	0.085	0.177
K	0.0140	0.0285	0.35	0.69
L	0.0350	0.0401	0.89	1.02
S	0.0830	0.1039	2.10	2.64
V	0.0177	0.0236	0.45	0.60

